

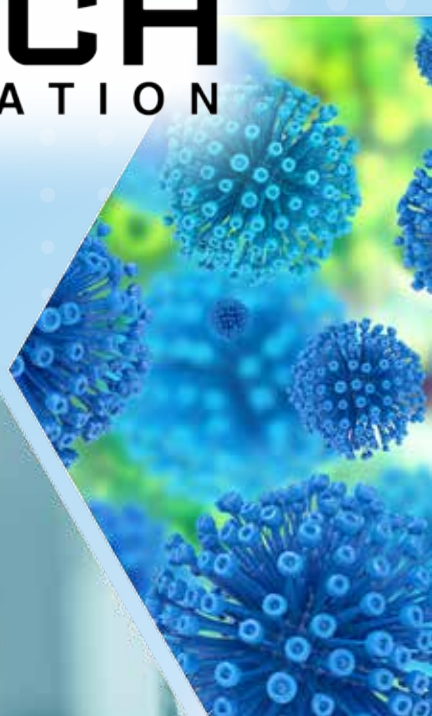

EBERBACH

CORPORATION



PRODUCT CATALOG
MIXING | MILLING | SHAKING | BLENDING



VISIT US ON THE WEB AT:
WWW.EBERBACHLABTOOLS.COM



Eberbach's history in Science dates back to 1843 ...



In 1843:

- Carl Gustaf Mosander Discovers Terbium and Erbium.
- The steam powered rotary printing press is invented by Richard March Hoe.
- Sir William Rowan Hamilton comes up with the idea of quaternions, a non-commutative extension of complex numbers.

And in the small town of Ann Arbor, Michigan, Christian Eberbach opened a pharmacy and began a laboratory supply business for local hospitals and universities. Thirty six years later Eberbach began manufacturing its own line of laboratory equipment beginning the over 130 year company history of building instruments and apparatus for the scientific community.

Today, Eberbach Corporation is an engineering and manufacturing company still located in Ann Arbor Michigan. Eberbach Corporation designs, builds and markets equipment for sample preparation, products such as Shakers, Mixers, Blenders, Stirrers and more. Eberbach products are used in a broad range of research and commercial applications, spanning biochemical, petrochemical, environmental, food, beverage and pharmaceuticals.

Eberbach is well known for its robust products, strong customer service and flexibility to deliver custom solutions to specific applications.

SALES

Our products can be purchased directly from Eberbach and are sold through authorized distributors throughout the world. Visit our website to see new products, current distributor listings or call customer service for technical support or repairs. We accept credit card payments, ACH/Wire as well as PayPal payments for direct orders.

TECH LINE

Call our technical advisors for product and application inquiries. We also recondition/repair your Eberbach products at our facility. Call for specifics concerning your particular requirements.

Advanced Engineering and Application Support.....	3
Shakers & Rotators.....	4
Shaker and Rotator Guide.....	5
Vortex Shakers.....	6
Hand-Motion Shakers.....	9
V-Mixer.....	11
Tumblers.....	12
Orbital Shakers.....	14
Reciprocal Shakers.....	20
Sieve Shakers.....	32
Shakers and Rotators Accessories.....	35
Cutting Mills.....	41
Stirrers.....	48
Hazardous Location Stirrers.....	49
Analog Overhead Stirrers.....	51
Digital Overhead Stirrers.....	52
Homogenizers.....	54
Analog Tissue Grinders.....	55
Digital Tissue Grinders.....	57
Stirrer/Grinder Accessories.....	60
Blenders.....	62
Explosion Proof E8017/8018.....	64
Waring® Laboratory Blenders & Assemblies.....	66
Blending Assemblies.....	69
Containers for Waring® Blenders.....	70
Parts for Waring® Blending Assemblies and Power Units.....	73
Microscope Slide Storage.....	75
Microscope Slide Cabinets.....	76
Microscope Slide Warming Table.....	78
Apparatus.....	79
Electro-Analyzer E1000.....	80
Cathetometer E5160.....	81



Advanced Engineering and Application Support Services

In addition to Eberbach's standard products, Eberbach offers engineering and application support services for specific mixing, blending, homogenizing and milling applications. Our focus on process excellence, mechanical engineering simulation, electrical engineering, in house manufacturing capability and our long history of manufacturing sample preparation equipment is the foundation to our engineering and application support services offering.

Our customers' application details and process goals are our number one priority when we design a custom system. Eberbach engineers work directly with customers to document the scope of work and define system requirements. Eberbach engineers use state of the art engineering software programs to design and test systems in solid models, they can then transfer component files directly through CAM software into CNC machines to manufacture the individual components for onsite system build. Eberbach individually tests and runs off each piece of equipment to ensure 100% system specification compliance and customer satisfaction.

Eberbach has a lot of experience with hazardous location specifications, wash-down applications, clean room, stainless steel applications and PCB design to draw upon when working with our customers to develop solutions for their applications and processes.

Eberbach is an ISO certified Engineering and Manufacturing company located in the USA.

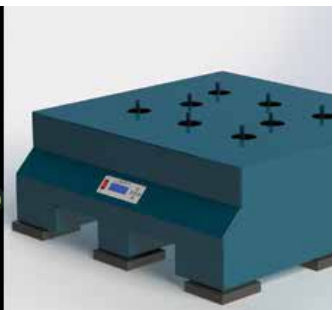
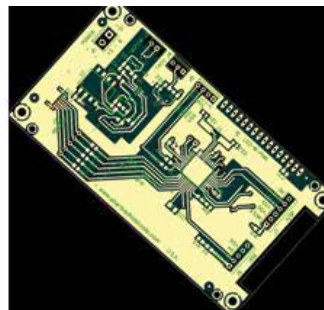

Shakers, Rotators & Mixers

Eberbach Shakers, Rotators & Mixers are known for their durability, ease of use and ability to mix solutions well. Eberbach Shakers, rotators and mixers are built for continuous duty with multiple options available.

If you need a specific solution, Eberbach Corporation has the flexibility to manufacture the solution for your specific application.

Eberbach designs and builds shakers, rotators and mixers with the following options:

- Heavy Duty Large Volume Mixing / Small Volume Mixing
- Fixed Speed / Variable Speed / High Speed / Low Speed
- Long Stroke / Regular Stroke / Small Stroke
- All Stainless Steel Models Available
- Custom Colors and Finishes
- Temperature Controlled Top Plate
- Explosion Proof / Hazardous Duty
- Remote Control Operation
- Tissue Homogenization
- OEM Builds



DURABILITY • CRAFTSMANSHIP • QUALITY

1-800-422-2558 | WWW.EBERBACHLABTOOLS.COM

Shakers & Rotators Guide

SHAKER ACTION	PHOTO	SPEED	HORIZONTAL DIS-PLACEMENT OR ORBITAL DIAMTER	LOAD MAX	CATALOG NUMBER	APPLICATIONS
VORTEXING <i>PAGE 6</i>		120-2200 rpm	0.125"	2 - 8 Titer Plates	E6120/ E6121	Rapid mixing of solutions, resuspension of particulates and other laboratory methods requiring energetic shaking.
HAND MOTION <i>PAGE 9</i>		100-960 osc/min	5.38 degrees	8.8 lbs	EL680	Low end - gentle to moderate shaking High End - vigorous dissolving or emulsifying
TUMBLING <i>PAGE 11</i>		0-100 rpm	360 degrees	Up to 60 lbs	EL655/ EL660/ EL665	Mix wet or dry samples, gently for suspensions, culturing and dry blending
ORBITAL <i>PAGE 14</i>		30-220 rpm	3/4" dia.	10 lbs	E2500	Swirling action extensively used in tissue culture work, fermentation, hybridization techniques
		30-350 rpm	3/4" dia.	Up to 70 lbs	E6130/ E6140	Swirling action extensively used in tissue culture work, fermentation, hybridization techniques
		30-320 rpm	1" dia.	150 lbs / 500 lbs	E6145/ E6155	Swirling action extensively used in tissue culture work, fermentation, hybridization techniques
RECIPROCAL <i>PAGE 19</i>		20-240 osc/min	1"	40 lbs	E5650	General Applications that call for reciprocal shaking action with digital speed and timing controls.
		60-240 osc/min	1.5"	100 lbs	E5900	General horizontal preparative shaking mixing - 2 phase extractions - suspension dissolving - aeration
		Fixed 180 or 280 osc/min	1.5"	40 lbs	E6010	General horizontal preparative shaking mixing - 2 phase extractions - suspension dissolving - aeration
HOT PLATE <i>PAGE 29</i>		20-240 osc/min	1"	40 lbs	E6360	Applications that call for reciprocal shaking action with a controlled heating element.
SIEVING <i>PAGE 30</i>		180 or 280 osc/min	1"	40 lbs	E6100	Applications that call for sieving dry material through multiple sieving pans.

PRODUCT: | E6120

PURPOSE: | SMALL MICROPLATE VORTEXER

Eberbach's Small Microplate Vortex Mixer is designed to produce vortex mixing of aqueous solutions in standard and deep well micro-titer plates. The 7" x 8.5" top plate moves in a tight 0.125" orbit at speeds between 120 - 2200 rpm. The built in clamps hold 2 deep well titer plates or four standard plates. This unit has a digital programmable timer with a digital tachometer which allows timed protocols or the shaker may be run continuously. This small bench top unit has rubber feet that prevent creeping.



PRODUCT SPECIFICATIONS...

SHAKING SPEED:	<ul style="list-style-type: none"> • Variable speed regulation from 120 - 2200 rpm • Speed is monitored within 1 rpm of setpoint by digital tachometer
OPERATING MODE:	Timer, Continuous operation
ORBIT:	0.125" (3.18 mm)
TYPE OF MOUNTING:	<ul style="list-style-type: none"> • Bench top • Suction cup feet to prevent creeping
LOAD CAPACITY:	4 regular titer plates or 2 deep well plates
POWER REQUIREMENTS:	115V, 50/60Hz or 230V, 50/60Hz
POWER CONSUMPTION:	30 Watts
SIZE AND WEIGHT:	Length: 7.5", Width: 6", Height: 6" Weight: 28 lbs
OPTIONS:	Incubator Compatible Model Available. Call for Details.

DURABILITY • CRAFTSMANSHIP • QUALITY

PRODUCT: | E6121
PURPOSE: | LARGE MICROPLATE VORTEXER

Eberbach's Large capacity Microplate Vortex Mixer is designed to produce vortex mixing of aqueous solutions in standard and deep well micro-titer plates. The top plate moves in a tight 0.125" orbit at speeds between 120-2200 rpm. The built in clamps hold 8 deep well titer plates or 16 standard plates (please contact us if you require larger tops to hold more microplates). The control interface includes a digital programmable timer with digital tachometer which allows timed protocols or the shaker may be run continuously. This vortexer also includes rubber feet to prevent creeping. The E6121.IN model is designed to withstand the environment of a high humidity CO2 incubator. Please contact us for integration into automation systems and robots for loading and unloading.



PRODUCT SPECIFICATIONS...

SHAKING SPEED:	• 120 - 2200 rpm
ORBIT:	• 0.125"
TYPE OF MOUNTING:	• Bench top • Suction cup feet to prevent creeping
LOAD CAPACITY:	16 titer plates - 8 Deep well titer plates
POWER REQUIREMENTS:	115V, 50/60Hz or 230V, 50/60Hz
POWER CONSUMPTION:	30 Watts
SIZE AND WEIGHT:	Length: 14", Width: 14", Height 6" Weight: 40 lbs
OPTIONS:	• Incubator Compatible Model Available. • Automation Integration • Larger options are also available

PRODUCT: | E6122

PURPOSE: | **MULTI-TUBE VORTEXER**

Eberbach’s multi-tube vortexer is designed to produce vortex mixing action of aqueous solutions in small flasks, vials, and tubes. The top plate moves in a tight 0.126” orbit at speeds between 600 - 2200 rpm. Eberbach’s clamping system can hold multiple tube sizes and (number of tubes held depends on tube size). The control interface includes a digital countdown timer with digital tachometer which allows timed protocols or the shaker may be run continuously. This vortexer is dynamically balanced for smooth continuous operation. Contact Eberbach for quote and specify tube size and number of tubes to be run on unit.



Polystyrene inserts can be custom made to accommodate most tube sizes.

PRODUCT SPECIFICATIONS...

SHAKING SPEED:	• 600 - 2200 rpm
ORBIT:	• 0.126”
TYPE OF MOUNTING:	• Bench top • Suction cup feet to prevent creeping
LOAD CAPACITY:	Accepts up to 9 lbs (Call or Email for more load options)
POWER REQUIREMENTS:	115V, 50/60Hz or 230V, 50/60Hz
POWER CONSUMPTION:	100 Watts
SIZE AND WEIGHT:	Length: 14”, Width: 14”, Height: 10” Weight: 77 lbs
OPTIONS:	Incubator Compatible Model Available. Call for Details.

DURABILITY • CRAFTSMANSHIP • QUALITY

1-800-422-2558 | WWW.EBERBACHLABTOOLS.COM

PRODUCT: | **EL680 & EL680.HD**
PURPOSE: | **HAND-MOTION SHAKER**

Eberbach's Hand-Motion Shaker EL680 is an effective tool for extracting, dissolving, and emulsifying samples. Commonly used for beer bitterness (BU) method in the brewing industry. Featuring an advanced motor, the EL680 mimics hand motion flask shaking from very slow gentle mixing to violent agitation. This variable speed unit runs from 100-960 osc/min (with gentle ramping), and is monitored within 1 rpm of set point by an illuminated digital tachometer.

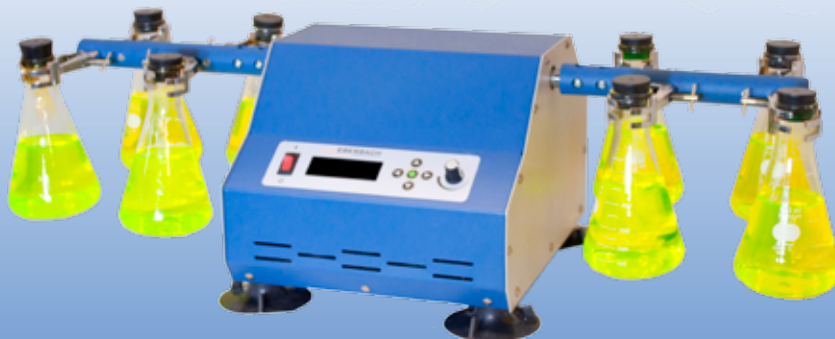

The control panel is angled away from the unit to ease reading and speed adjustment. The shaker has easily detachable arms equipped with 8 clamps for attachment of all types of tubes, flasks and bottles with diameters between 5 and 50 mm. The EL680 includes a digital timer, rubber feet, and can handle loads up to 10 lbs.

PRODUCT SPECIFICATIONS...

SHAKING SPEED:	<ul style="list-style-type: none"> • Variable speed regulation from 100 - 960 osc/min • Speed is monitored within 1 rpm of setpoint by digital tachometer
STROKE:	<ul style="list-style-type: none"> • 5.38 Degrees full arc
SETUP OPTIONS:	<ul style="list-style-type: none"> • Eight (8) clamps can be attached with all types of tubes, bottles, flasks of diameter between 5 - 50 mm • Custom arms available upon request
TYPE OF MOUNTING:	<ul style="list-style-type: none"> • Bench top • Suction cup feet prevent creeping
LOAD CAPACITY:	Accepts up to 8.8 lbs HD Model accepts up to 10 lbs
POWER REQUIREMENTS:	115V, 50/60Hz or 230V, 50/60Hz
POWER CONSUMPTION:	100 Watts
SIZE AND WEIGHT:	Length: 33", Width: 14", Height: 10" Weight: 70 lbs

PRODUCT: | **EL680.Q**
PURPOSE: | **QUECHERS HAND-MOTION SHAKER**

Eberbach's Hand-Motion Shaker EL680.Q with QuEChERS tooling for extracting, dissolving and emulsifying samples. Featuring an advanced motor, the EL680 mimics hand motion flask shaking from very slow, gentle mixing to violent agitation. This variable speed unit runs from 100-600 osc/min (with gentle ramping), and is monitored within 1 rpm of set point by an illuminated digital tachometer. The control panel is angled away from the unit to ease reading and speed adjustment. With the EL680 & QuEChERS Tool-



ing the user can put in multiple tubes (multiple sizes from 50ml down to 15ml, 12 per arm) at a time. The EL680.Q includes a digital timer, rubber feet, and can handle loads up to 8.8 lbs.

PRODUCT SPECIFICATIONS...

SHAKING SPEED:	<ul style="list-style-type: none"> • Variable speed regulation from 100 - 600 osc/min • Speed is monitored within 1 rpm of setpoint by digital tachometer
STROKE:	<ul style="list-style-type: none"> • 13.58 Degrees full arc
SETUP OPTIONS:	<ul style="list-style-type: none"> • 2 arms can be attached with all tubes of diameter between 15ml to 50ml • Custom arms available upon request (Call for any changes needed)
TYPE OF MOUNTING:	<ul style="list-style-type: none"> • Bench top • Suction cup feet prevent creeping
LOAD CAPACITY:	Accepts up to 8.8 lbs
POWER REQUIREMENTS:	115V, 50/60Hz or 230V, 50/60Hz
POWER CONSUMPTION:	95 Watts
SIZE AND WEIGHT:	Length: 33", Width: 14, Height: 10" Weight: 86 lbs

DURABILITY • CRAFTSMANSHIP • QUALITY

PRODUCT: | **EL705 & EL703**

PURPOSE: | **V-BLENDER AND EXPLOSION PROOF V-BLENDER**

The EL705 Explosion Proof V Blender is designed for dry blending of free flowing solids that themselves present a potential explosion hazard, or need to be blended in an environment that has explosive dusts within the atmosphere. Solids being blended are constantly being split and recombined as the V blender chamber rotates.

Eberbach can produce V-Blenders in a variety of sizes from table top sized units for research and development to pilot size batch manufacturing to full scale large volume production. Each V-chamber is constructed of 316-stainless steel with the interior having a mirror finish RA value 10 micro inches to prevent sample from sticking to the internal walls. The outside of the chamber is polished to an RA value of 32 micro inches to enable easy cleaning of the unit.

The chamber opening has a dust tight design that opens with a simple latching mechanism. Explosion resistance classifications can be adjusted based on customer environmental factors. Please note that this unit must be installed by a qualified electrician to preserve their electrically explosion-proof capability.

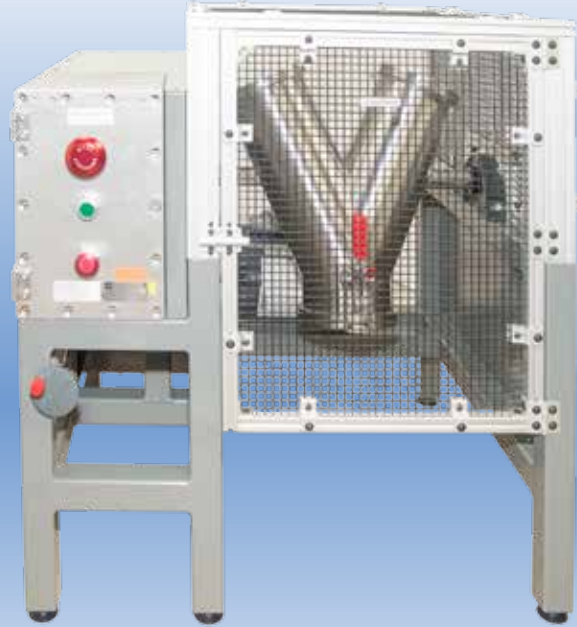

PRODUCT SPECIFICATIONS...

SHAKING SPEED:	5 - 36 rpm
MAX HOLDING CAPACITY:	.5 Cubic Feet
MAX WORKING CAPACITY:	.25 Cubic Feet
EXPLOSION PROOF CLASSIFICATION:	Electrically Explosion Proof: Class 1 Division 1 Groups C, and D. Class 2 Division 1 Groups E, F, and G
POWER REQUIREMENTS:	230V AC 3 Phase
SIZE AND WEIGHT:	Length: 35", Width: 30", Height: 40" Weight: 400 lbs
OPTIONS:	<ul style="list-style-type: none"> • Stainless Steel construction • Non-Explosion Proof EL703

PRODUCT: | **EL655, EL660 AND EL665**
PURPOSE: | **6 POSITION INVERSION TUMBLER**

The EL655 Programmable Inversion Tumbler is designed to mix wet or dry samples, gently for suspensions, culturing and dry blending or more aggressively by programming the tumbler to rotate clockwise stopping and then rotating counterclockwise. It is useful in keeping insoluble particles in suspension to minimize the introduction of air into the solution, dry blending powders as well as aggressively agitating chemicals. In addition, it can also be used in liquid/liquid extractions in situations where typical vigorous shaking is inappropriate (i.e. if you don't want to introduce air into the solutions).



The EL655 Programmable Inversion Tumbler can also be used to blend dry powders. The standard unit accepts 6 bottles or jars up to 7" in height. An interlocked safety switch on the door is supplied with the unit along with a new upgraded aluminum plate base with integrated handles for ease of moving. Stainless steel sanitary models available, please call for pricing.

PRODUCT SPECIFICATIONS...

ROTATING SPEED:	0 - 100 rpm
TYPE OF MOUNTING:	Bench top
LOAD CAPACITY:	EL655: 12.5 lbs - Accepts 6 Jars/bottles up to 7 in. tall. EL660: 25 lbs - Accepts 6 Jars/Bottles up to 9" tall and 3.5" in diameter
POWER REQUIREMENTS:	115V, 50/60Hz or 230V, 50/60Hz
POWER CONSUMPTION:	30 Watts
SIZE AND WEIGHT:	Length: 31", Width: 11.5", Height: 13.5" Weight: 70 lbs
OPTIONS:	<ul style="list-style-type: none"> • Stainless Steel construction • High Capacity/Large Container Tumbler EL665 also available

PRODUCT: | **EL655.I**

PURPOSE: | **INCUBATOR TUMBLER**

The EL655.I Programmable Incubator Tumbler is designed to optimize cell growth in small volumes by improving suspension, aeration and temperature control. The EL655.I keeps fluid moving in a gentle way while increasing the surface area of the liquid air interface for improved cell aeration. The EL655.I can also be used for more aggressive mixing with temperature control applications by programming the tumbler to rotate clockwise stopping and then rotating counterclockwise and can repeat this cycle as many times as required.

The EL655.I is designed to accommodate 2ml, 15ml and 50ml tubes as well as other containers up to 7 inch long and 3 inch diameter (other sizes are available upon request). The EL655.I does not come with tube/bottle/container clamps; these are sold separately and can easily be changed depending on applications. A tempered glass window is positioned in front of the unit for viewing inside the incubator. The interior chamber itself is constructed of polished 316 stainless steel ease cleaning. Contact us for larger volume units (EL660.I) including refrigeration units that go below ambient temperature.



PRODUCT SPECIFICATIONS...

ROTATING SPEED:	0 - 100 rpm (programmable with audible alarm)
ROTATION DIRECTION:	Clockwise and counterclockwise rotation (programmable cycle) with jog function to shake/vibrate tubes and containers
LOAD CAPACITY:	20 lbs - Accepts 6 Tubes/Jars/Bottles up to 7 in. tall and 3 in. wide. Custom options available.
TEMPERATURE RANGE:	3°C above ambient to 55°C (programmable with alarm)
TEMPERATURE CONTROL:	± 0.2° C
TEMPERATURE UNIFORMITY:	± 0.5° C
TIMER:	1 sec – 999hrs 59min 59secs (programmable with alarm)
DATA OUTPUT VIA USB:	RPM, TIMER, TEMPERATURE (CSV FILE)
SIZE AND WEIGHT:	Length: 31", Width: 14", Height: 14" Weight: 116 lbs

PRODUCT: | **E2500**

PURPOSE: | **CLINICAL ROTATOR**

Eberbach's Clinical Rotator E2500 is designed for V.D.R.L., Mazzini, Kline, Boerner-Jones-Luken, cardiolipin, other serological tests, and clinical applications within a speed range of 30 - 220 rpm. A 13" square platform with sponge rubber pad orbits 6" above the bench. The new controller has a digital tachometer along with digital countdown timer. The programmable timer can be selected for timed operation or the unit can be switched for constant operation. The 30W motor has permanently lubricated bearings and is rated for continuous operation in the load range of up to 12 lbs. The Case measures 13" x 14" and is mounted on four suction feet to reduce creeping. At a given speed setting the motor maintains a constant speed regardless of changes in line voltage, load or temperature variations. Every point on the surface of the rotator travels through a uniform .75" diameter circle in the horizontal plane.



PRODUCT SPECIFICATIONS...

ROTATING SPEED:	30 - 220 rpm
TYPE OF MOUNTING:	<ul style="list-style-type: none"> • Bench top • Suction cup feet to prevent creeping
LOAD CAPACITY:	Accepts loads up to 12 lbs
POWER REQUIREMENTS:	115V/230V, 50/60Hz
POWER CONSUMPTION:	30 Watts
SIZE AND WEIGHT:	Length: 14.3", Width: 13.2", Height: 5.2" Weight: 20 lbs
OPTIONS:	<ul style="list-style-type: none"> • Slide Carrier (Order No. E2550) holds nine 50 x 75 mm slides; aluminum carrier is formed to fit over the 13" square platform of the Rotator • Slide Carrier (Order No. E2560) similar to No. E2550 Carrier but designed to hold nine 58 x 75 mm slide • Plastic Cover (Order No. E2565) for covering the platform of the Model E2500 Clinical Rotator, or No. E2550 - E2560 Slide Carriers • Incubator Compatible Model Available. Call for Details.

DURABILITY • CRAFTSMANSHIP • QUALITY

PRODUCT: | **E6130**

PURPOSE: | **BENCH TOP ORBITAL SHAKER**

Eberbach's bench top variable speed orbital shaker is designed for rotary swirling action and used for bioprocessing of plant cell cultures, mammalian cell culturing, aeration of fermentations and various other chemical mixing procedures. The E6130 is designed to occupy a minimum table top space yet allow for the versatility offered by larger units with its increased load capacity (unit can accommodate loads up to 25 lbs). The E6130 can be used with optional utility box, flask holders or if you need to hold something special just ask Eberbach to quote a custom holder for your application. The E6130 uses Eberbach's own controller which has a digital tachometer along with digital countdown timer and optional audible end of cycle alarm. The digital countdown timer can be selected for timed operation or turned off for constant operation. The eccentric drive is counterbalanced to assure smooth acceleration and minimal bearing wear for increased life of the machine. Speed is continuously variable between from 30 - 350 rpm or with the Eberbach controller you can program your specific speed. The 30W motor has permanently lubricated bearings and is rated for continuous operation. The E6130.IN model is also available and designed to also withstand the environment of a high humidity CO2 incubator.



Shown with optional Erlenmeyer flask holders and top plate

PRODUCT SPECIFICATIONS...

ROTATING SPEED:	30 - 350 rpm
ORBIT:	.75" (Can be factory set to 0.5" to 1")
TYPE OF MOUNTING:	<ul style="list-style-type: none"> • Bench top • Suction cup feet to prevent creeping
LOAD CAPACITY:	Accepts loads up to 25 lbs
POWER REQUIREMENTS:	115V, 50/60Hz or 230V, 50/60Hz
POWER CONSUMPTION:	30 Watts
SIZE AND WEIGHT:	Length: 14", Width: 14", Height: 6" Weight: 41 lbs
OPTIONS:	<ul style="list-style-type: none"> • Utility Box Carrier: (Includes 1 crosswise bar clamp) Order No. E6135 • Shaker Platform: 14" x 16.5" Order No. E6132 • Erlenmeyer Flask Holders: 10 - 6000 ml Order No. E6090.XX

PRODUCT: | **E6140**

PURPOSE: | **HIGH HUMIDITY ORBITAL SHAKER**

The E6140 is a low profile orbital shaker, designed for rotary swirling action and used for bioprocessing of plant cell cultures, mammalian cell culturing, aeration of fermentations and various other chemical mixing procedures. The E6140 orbital shaker can be used in high humidity/CO2 incubators. Measuring 23" x 21.3" x 8" this shaker is suitable for use in laboratory incubators or walk-in warm rooms. The shaker features a 100W brushless DC motor, tachometer/timer and a gentle start-up cycle to insure that glassware stays where it belongs. The eccentric drive is counterbalanced for smooth acceleration and extended bearing life. The speed range is 30-320 rpm with a maximum load of 70 lbs. Accessory platform (E6140.A.P), and box carrier (E6140.A.UB) are sold separately. Designed to withstand the environment of a high humidity CO2 incubator. Please contact us for integration into automation systems and robots for loading and unloading.



Shown in Stainless Steel with optional Custom Carrier

PRODUCT SPECIFICATIONS...

ROTATING SPEED:	30 - 320 rpm
ORBIT:	1" (Can be factory set up to 2")
TYPE OF MOUNTING:	<ul style="list-style-type: none"> • Bench top • Suction cup feet to prevent creeping
HUMIDITY RATING:	100%
CO2 RATING:	8%
TEMPERATURE RATING:	32 - 140 degrees fahrenheit
LOAD CAPACITY:	70 lbs
POWER REQUIREMENTS:	115/230V, 50/60Hz
POWER CONSUMPTION:	100 Watts
SIZE AND WEIGHT:	Length: 21", Width: 23", Height: 8" Weight: 92 lbs
OPTIONS:	<ul style="list-style-type: none"> • Flask holders of various sizes can be mounted to top platform (E6090) • Top Plate Platform 21" x 21" Order No. E6140.A.P • Stand alone Utility Box Carrier Order No. E6140.A.UB

DURABILITY • CRAFTSMANSHIP • QUALITY

PRODUCT: | E6145

PURPOSE: | MID RANGE VARIABLE SPEED ORBITAL SHAKER

Eberbach's Mid-Range Variable-Speed Orbital Shakers are designed for rotary swirling action and used for bioprocessing of plant cell cultures, mammalian cell culturing, aeration of fermentations and various other chemical mixing procedures. Like all Eberbach Shakers, the E6145 orbital shakers are simple to use and maintain. The E6145 uses Eberbach's own controller which has a digital tachometer along with digital countdown timer and optional audible end of cycle alarm. The digital countdown timer can be selected for timed operation or turned off for constant operation. The eccentric drive is counterbalanced to assure smooth acceleration and minimal bearing wear for increased life of the machine. Speed is continuously variable between from 30 - 320 rpm or with the Eberbach controller you can program your specific speed. The E6145 has a 1" diameter orbit to insure uniform agitation to all containers. The E6145 has a load capacity up to 150 lbs. Please contact us for integration into automation systems and robots for loading and unloading.



E6145 with optional E6169.DS Box Carrier

PRODUCT SPECIFICATIONS...

ROTATING SPEED:	30 - 320 rpm
ORBIT:	1" (Can be factory set up to 3")
TYPE OF MOUNTING:	<ul style="list-style-type: none"> • Floor • Suction cup feet to prevent creeping
LOAD CAPACITY:	Accepts loads up to 150 lbs
POWER REQUIREMENTS:	115V, 50/60Hz or 230V, 50/60Hz
POWER CONSUMPTION:	95 Watts
SIZE AND WEIGHT:	Length: 34", Width: 27", (Height varies by accessory) Weight: 150 lbs
OPTIONS:	<ul style="list-style-type: none"> • Flask holders of various sizes can be mounted to top platform (E6090) • Top Plate Platform 27" x 24" Order No. E6165 w/ Carrier E6162 • Stand alone Utility Box Carrier Order No. E6169 • Stand alone Double Stack Utility Box Carrier Order No. E6169.DS

PRODUCT: | E6145.IS.S AND E6145.LC.SS
PURPOSE: | SPECIALITY MODELS

E6145.IS.S:

The E6145.IS.S is built with the same capabilities as the standard E6145, but with a 316 Stainless Steel Exterior and a reinforced pallet jack base that allows the unit to be easily moved from one location to another. The stainless steel exterior makes this unit robust and easy to clean.

This model has the following specs:

ROTATING SPEED:	30 - 320 rpm
ORBIT:	1" (Can be factory set up to 3")
TYPE OF MOUNTING:	Pallet Jack Base
LOAD CAPACITY:	Accepts loads up to 150 lbs



E6145.IS.S with optional E6069.DS Box Carrier

E6145.LC.SS:

The E6145.LC.SS is the most advanced orbital shaker built by Eberbach. Built with the reinforced pallet base structure of the E6145.IS.S, this shaker is capable of measuring the weight of your sample prior to shaking and after. The integrated HMI allows this unit to be integrated into production work flows and monitoring solutions.

This model has the following specs:

ROTATING SPEED:	35 - 150 rpm
ORBIT:	1" (Can be factory set up to 3")
TYPE OF MOUNTING:	Pallet Jack Base
LOAD CAPACITY:	Accepts loads up to 65 lbs



E6145.LC.SS Orbital Shaker with Scale

PRODUCT: | **E6155**

PURPOSE: | **HEAVY DUTY ORBITAL SHAKER**

Eberbach's large capacity Variable-Speed Orbital Shakers are designed for rotary swirling action and is used for bioprocessing of plant cell cultures, large batch mammalian cell culturing, aeration of fermentations and various other chemical mixing procedures.

The orbital motion of the E6155 ensures efficient liquid mixing. The E6155 allows high oxygen transfer rates with low shear forces not seen with other bio-reactors which use propellers or impellers. The E6155 reduces stress on cells thanks to the swirling action of the shaker. This motion is particularly suitable for cell cultivation and fermentation. The E6155 uses Eberbach unique balanced bearing plates for a long lasting smooth operation, repeatable motion with accurate control of the orbital speed and time duration.

When used with optional biochemical sensors, the E6155 is ideal for scale-up fermentation, cultivation and bio processing applications. The base is designed to be moved with a forklift or pallet jack. The E6155 uses Eberbach's own controller which has a digital tachometer along with digital countdown timer and optional audible end of cycle alarm. The digital countdown timer can be selected for timed operation or turned off for constant operation. The eccentric drive is counterbalanced



Shown with optional E6175 Box Carrier

to assure smooth acceleration and minimal bearing wear for increased life of the machine. Speed is continuously variable between from 30 - 300 rpm or with the Eberbach controller you can program your specific speed. The E6155 comes factory set with a 2" (5 cm) orbit, if your application requires a different orbit size we can offer alternative sizes.

PRODUCT SPECIFICATIONS...

ROTATING SPEED:	30 - 300 rpm
ORBIT:	2" (Can be factory set up 1-3")
TYPE OF MOUNTING:	Floor, Suction feet to prevent creeping and Built-in Pallet Stand for ease of placement and relocation.
LOAD CAPACITY:	50 lbs - 500 lbs
POWER REQUIREMENTS:	115V, 50/60Hz or 230V, 50/60Hz
POWER CONSUMPTION:	480 Watts
DIMENSIONS:	Length: 43", Width: 43", Height: 22.5" (Without Box Carrier) Weight: 2136 lbs
OPTIONS:	<ul style="list-style-type: none"> • Stainless Steel Wash-Down Model • Remote Control (Wall Mount or Control Stand) • Custom Box Carrier or Platform • Explosion Proof / Harsh Environment

DURABILITY • CRAFTSMANSHIP • QUALITY

PRODUCT: | **E5650**

PURPOSE: | **DIGITAL BENCH TOP RECIPROCAL SHAKER**

Eberbach's E5650 Digital Bench top Reciprocal Shaker is designed expressly to occupy a minimum of bench space while maintaining the versatility of our larger units. The unit is powered by a 1/17 hp Bodine DC motor which drives the platform through a filtered SCR controller. The speed is continuously variable between a range of 20 - 240 osc/min. Yet, at a given setting the speed is constant and is not affected by normal line voltage fluctuations. The horizontal stroke is factory set at 1". A 1.5" stroke model is also available. This reciprocal shaker model will shake a load of 40 lbs at low speed and 20 lbs at maximum. Its bench top footprint measures 21"x 15". A digital controller controls platform speed and allows for timed operations. A stainless steel model E5650.SS and a incubator ready model E5650.IN are also available. Contact Eberbach for details.



Shown with optional E6040 box carrier

PRODUCT SPECIFICATIONS...

ROTATING SPEED:	20 - 240 osc/min
STROKE:	1" (Can be factory set up to 1.5")
TYPE OF MOUNTING:	<ul style="list-style-type: none"> • Bench top • Suction cup feet to prevent creeping
LOAD CAPACITY:	Accepts loads up to 40 lbs at low speed 20 lbs at high speed
POWER REQUIREMENTS:	115V, 50/60Hz or 230V, 50/60Hz
POWER CONSUMPTION:	45 Watts
SIZE AND WEIGHT:	Length: 19.5", Width: 14.5", Height: 10" (with box carrier), Weight: 40 lbs
OPTIONS:	<ul style="list-style-type: none"> • Flask holders (E6090) can be mounted on an optional platform (E6061) • Utility box carrier (E6040) with rubber surface and one (1) rubber coated bar • Platform tiering post available for increased shaking capacity

DURABILITY • CRAFTSMANSHIP • QUALITY

PRODUCT: E5703.IWE
PURPOSE: ICE WATER EXTRACTOR

Eberbach's E5703.IWE Ice Water Extractor is designed for the removal and separation of plant trichomes from the plant exterior with no solvents; this is a 100% solvent free extraction system. All surfaces that contact the water are food grade material and washable. The E5703.IWE has a programable speed and time control with spill resistant electronics. The E5703.IWE is designed for high throughput processing use where food grade equipment and FDA compliance is required. This system is capable of processing over 1 lb of plant material per hour. For more information and instructions please contact us.



PRODUCT SPECIFICATIONS...

OPERATING SPEED:	20 - 100 osc/min
SCREEN FOR TRICHOME SEPARATION:	300 Micron - 20 Micron. The machine is supplied with six (6) sizes; please contact us to let us know what sizes you need.
LOAD CAPACITY:	Approximately 1lb of plant material per cycle
POWER REQUIREMENTS:	115V, 50/60Hz or 230V, 50/60Hz, CE & UL
POWER CONSUMPTION:	95 Watts
SIZE AND WEIGHT:	Length: 41", Width: 36", Height: 46" Weight: 340 lbs
OPTIONS:	<ul style="list-style-type: none"> • Fully automatic model available with auto water fill and auto ice fill • Washdown (IP67) model available • Larger capacity models available

DURABILITY • CRAFTSMANSHIP • QUALITY

PRODUCT: | **E5703**

PURPOSE: | **LONG STROKE RECIPROCAL SHAKER**

Eberbach's Long Stroke Reciprocal Shaker is designed for applications where your samples require an extra long aggressive mixing action. The shaker is equipped with handle bars for easy deployment and a digital tachometer and timer for easy program setup. The E5703 was designed to withstand extreme environments with moisture and spill resistant electronics. An optional hard travel case for the unit is also available that includes a toolkit for servicing the unit along with spare parts.

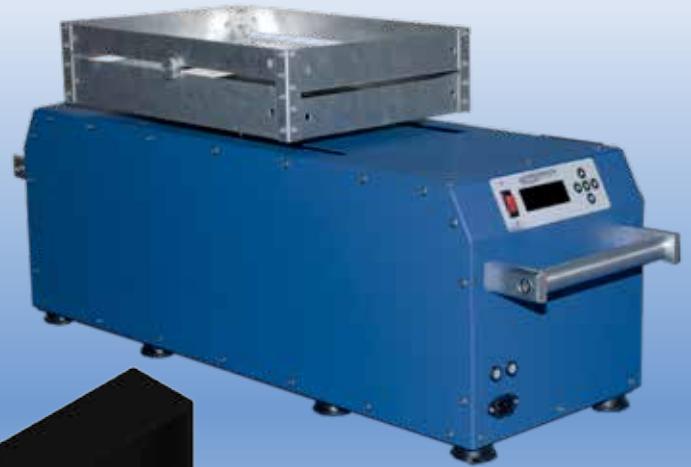

Shown with optional E6040 box carrier

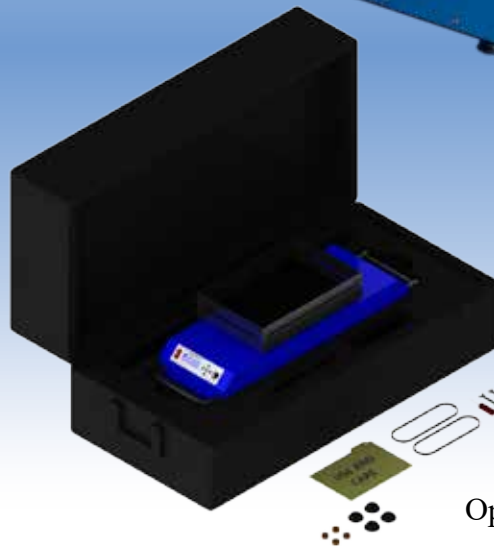

Optional Hard Travel Case

PRODUCT SPECIFICATIONS...

OPERATING SPEED:	20 - 130 osc/min
STROKE:	6.5"
LOAD CAPACITY:	Accepts loads up to 40 lbs
POWER REQUIREMENTS:	115V, 50/60Hz or 230V, 50/60Hz
POWER CONSUMPTION:	95 Watts
SIZE AND WEIGHT:	Length: 40", Width: 11.9", Height: 16.5" Weight: 75 lbs
OPTIONS:	• Hard Travel Case with spare parts and tool kit

DURABILITY • CRAFTSMANSHIP • QUALITY

PRODUCT: | **E5850**

PURPOSE: | **ECONOMY BENCH TOP RECIPROCAL SHAKER**

The E5850 Variable-Speed Bench top Reciprocal Shaker expressly to occupy a minimum of bench space while maintaining the versatility of our larger units. The unit is powered by a 1/17 hp Bodine DC motor which drives the platform through a filtered SCR controller. The speed is continuously variable between a range of 20-240 osc/min. Yet, at a given setting the speed is constant and is not affected by normal line voltage fluctuations. Model E5850 will shake a load of 40 lbs at low speed and 20 lbs at high speed. Its bench top footprint measures 21" x 15". This unit can be optionally equipped with either an aluminum platform (E6061) measuring 22.5"L x 12"W containing 168-1/4" holes for securing Eberbach E6090 Erlenmeyer flask holders which can hold numerous configurations of Erlenmeyer flasks or a E6040 utility box carrier. A stainless steel model E5850.SS and a incubator ready model E5850.IN are also available. Contact Eberbach for details.



Shown with optional E6040 Box Carrier

PRODUCT SPECIFICATIONS...

OPERATING SPEED:	20 - 240 osc/min
STROKE:	1" (1.5" model is also available)
TYPE OF MOUNTING:	<ul style="list-style-type: none"> • Bench top • Suction cup feet to prevent creeping
LOAD CAPACITY:	Accepts loads up to 40 lbs at low speed 20 lbs at high speed
POWER REQUIREMENTS:	115V, 50/60Hz or 230V, 50/60Hz
POWER CONSUMPTION:	45 Watts
SIZE AND WEIGHT:	Length: 21", Width: 15", Height: 10" (with box carrier), Weight: 40 lbs
OPTIONS:	<ul style="list-style-type: none"> • Flask holders (E6090) of various sizes can be mounted on an optional platform (E6061) • Utility box carrier (E6040) with anti-slide surface and one (1) rubber coated bar is available to hold numerous configurations of beakers, flasks, etc. • Platform tiering post available for increased shaking capacity • Separatory funnel holders (E6095) are also available

PRODUCT: | **E5900**

PURPOSE: | **LARGE HEAVY DUTY RECIPROCAL SHAKER**

Eberbach's Large heavy-duty Variable-Speed Reciprocal Shaker E5900 is designed to shake large containers or large quantities of smaller containers. Essentially a floor unit, the E5900 can handle loads up to 100 lbs with the capability of running 24/7 while needing only routine maintenance. The E5900 is powered by a 1/6 hp synchronous split phase motor which drives the platform through a mechanical transmission utilizing a variable pitch pulley system incorporating a V-belt drive. Speed is continuously variable between a range of 60-240 osc/min. (Due to the mechanical transmission upper and lower speed limits may vary by 5%). The horizontal stroke is fixed at 1.5". The shaker is typically set up with a E5910 large platform (not included) that allows attachment of Erlenmeyer flask holders, separatory funnel holders or a E5915 box carrier that allows the mounting of hard to hold containers. A digital countdown timer and/or a digital tachometer are available as add on features to further meet your particular procedural requirements. A Explosion-Proof Model (Order No. E5905) is also available. Please call Eberbach technical service for installation considerations concerning the explosion proof unit.



Shown with optional E5919 Box Carrier

Built with Rocker Arm Technology - See Page 34 for details.

PRODUCT SPECIFICATIONS...

SPECIALTY MODELS:	Explosion Proof - Order number E5905 Stainless Steel model E5900.SS is available by request. Call for Quote.
OPERATING SPEED:	Variable speed 60 - 240 osc/min
STROKE:	1.5" Horizontal - Custom stroke lengths available
TYPE OF MOUNTING:	Floor Model with suction cup feet to prevent creeping
LOAD CAPACITY:	Accepts up to 100 lbs
POWER REQUIREMENTS:	115V or 230V, 50Hz or 60Hz Explosion-Proof Unit: 115V 60Hz or 230V 50 Hz - Order E5905
SIZE AND WEIGHT:	Length: 39.2" Width: 20.2", Height: 10.7" (base unit) Weight: 160 lbs
OPTIONS:	<ul style="list-style-type: none"> • Top Platform: 36" x 24", Order No. E5910 • Utility Box Carrier: 36"L x 24"W x 6"H, with one bar clamp, Order No. E5919 • Bar Clamps: 24" Crosswise, Order No. E5917 • Erlenmeyer Flask Holders: 10 - 6000 ml Order No. E6090.XX • Threaded Strips: (for use with flask holders), Order No. E5913 • Stainless Steel Wash-Down model

DURABILITY • CRAFTSMANSHIP • QUALITY

PRODUCT: | **E5902.HD**

PURPOSE: | **LARGE HEAVY DUTY RECIPROCAL SHAKER**

Eberbach's Large 2 Speed Reciprocal Shaker E5902.HD is designed to shake large containers or large quantities of smaller containers. Essentially a floor unit, the E5902.HD can handle loads up to 250 lbs with the capability of running 24/7 while needing only routine maintenance. The E5902.HD is powered by a 1/6 hp split phase motor which drives the platform through a mechanical transmission. The horizontal stroke is fixed at 1.5". The shaker is typically set up with a E5910 large platform (not included) that allows attachment of Erlenmeyer flask holders, separatory funnel holders or a E5919 box carrier that allows the mounting of hard to hold containers. Speeds are 160 and 240 osc/min.



Shown with optional Stand and Custom Carrier

PRODUCT SPECIFICATIONS...

SPECIALTY MODELS:	Speed control with digital tachometer, digital countdown timer - Order E5903.HD Stainless Steel model available by request. Call for Quote.
OPERATING SPEED:	2 speed 160 - 240 osc/min (+/- 5 osc/min)
STROKE:	1.5" Horizontal - Custom stroke lengths available
TYPE OF MOUNTING:	Floor Model with suction cup feet to prevent creeping
LOAD CAPACITY:	Accepts up to 250 lbs
POWER REQUIREMENTS:	115V or 230V, 50Hz or 60Hz
SIZE AND WEIGHT:	Length: 43", Width: 22", Height: 10.5" (Without carrier or stand) Weight: 220 lbs
OPTIONS:	<ul style="list-style-type: none"> • Top Platform: 36" x 24", Order No. E5910 • Utility Box Carrier: 36"L x 24"W x 6"H, with one bar clamp, Order No. E5919 • Bar Clamps: 24" Crosswise, Order No. E5917 • Erlenmeyer Flask Holders: 10, 25, 50, 125, 250, 500, 1000, 1500, 2000, 2800, 4000, 6000 ml, Order No. E6090 • Threaded Strips: (for use with flask holders), Order No. E5913 • Stainless Steel Wash-Down models available

PRODUCT: | E5903

PURPOSE: | LARGE HEAVY DUTY DIGITAL RECIPROCAL SHAKER

Eberbach's E5903 Digital Heavy-Duty Variable-Speed Reciprocal Shaker is the same as the model E5900 but with a 1/2 hp brushless DC motor and speed controller, digital tachometer and a digital countdown timer. Designed to shake large containers or large quantities of smaller containers this unit can handle loads up to 100 lbs with the capability of running 24/7 while needing only routine maintenance. Speed control is continuously variable between a range of 60-240 osc/min. The horizontal stroke is fixed at 1.5". The shaker is typically set up with a E5910 large platform (not included) that allows attachment of Erlenmeyer flask holders, separatory funnel holders or a E5919 box carrier that allows the mounting of hard to hold containers.



Shown with optional Stand and Carrier

PRODUCT SPECIFICATIONS...

SPECIALTY MODELS:	Stainless Steel model available by request. Call for Quote.
OPERATING SPEED:	Variable speed 60 - 240 osc/min
STROKE:	1.5" Horizontal - Custom stroke lengths available
TYPE OF MOUNTING:	Floor Model with suction cup feet to prevent creeping
LOAD CAPACITY:	Accepts up to 100 lbs
POWER REQUIREMENTS:	115V or 230V, 50Hz or 60Hz
SIZE AND WEIGHT:	Length: 39", Width: 20", Height: 11" (without box carrier or stand) Weight: 160 lbs
OPTIONS:	<ul style="list-style-type: none"> • Top Platform: 36" x 24", Order No. E5910 • Utility Box Carrier: 36"L x 24"W x 6"H, with one bar clamp, Order No. E5919 • Bar Clamps: 24" Crosswise, Order No. E5917 • Erlenmeyer Flask Holders: 10, 25, 50, 125, 250, 500, 1000, 1500, 2000, 2800, 4000, 6000 ml, Order No. E6090 • Threaded Strips: (for use with flask holders), Order No. E5913 • Stainless Steel Wash-Down models available

DURABILITY • CRAFTSMANSHIP • QUALITY

PRODUCT: | **E5903.HDP**

PURPOSE: | **PRODUCTION READY RECIPROCAL SHAKER**

Eberbach's E5903.HDP is a Production Ready Heavy-Duty Reciprocal Shaker. With a weight capacity of 500 lbs this shaker is one of the heaviest duty shakers Eberbach offers within our standard products (Higher weight capacities are available upon request). The E5903.HDP is designed for continuous duty and includes a wall mountable digital controller for programming speed and time (1 min to 999 hours or non-stop). The E5903.HDP comes equipped with multiple emergency stop buttons and easy access leveling feet. The standard carrier has an internal dimension of 55.5 in. x 22 in. x 10 in. The carrier can be customized to your specific application or need.



PRODUCT SPECIFICATIONS...

SPECIALTY MODELS:	Stainless Steel or Explosion resistant models available by request. Call for Quote.
OPERATING SPEED:	Variable speed 60 - 250 osc/min (+/- 5%)
STROKE:	1.5" Horizontal - Custom stroke lengths available
TYPE OF MOUNTING:	Floor Unit with Adjustable Feet.
LOAD CAPACITY:	Accepts up to 500 lbs
POWER REQUIREMENTS:	115V or 230V, 50Hz or 60Hz
SIZE AND WEIGHT:	Length: 62.5", Width: 24", Height: 43" Weight: 1910 lbs
NOTES:	<ul style="list-style-type: none"> • Power Requirements: Customer Specific • Utility Box Carrier: 55.5 in. x 22 in. x 10 in. (Custom sizes available) • Digital Controller: Wired or Wireless Available.

PRODUCT: | **E6000**

PURPOSE: | **MID-RANGE HEAVY DUTY RECIPROCAL SHAKER**

The E6000 Variable-Speed Mid-Range Reciprocal Shaker is designed for your general purpose shaking needs. Like all Eberbach Shakers, the E6000 is designed for ease of use and maintenance. This heavy-duty unit operates in a space of 33.5" x 20" and is powered by a 1/6 hp synchronous split phase motor which drives the platform through a mechanical transmission utilizing a variable pitch pulley system incorporating a V-belt drive. Speed control is continuously variable between a range of 60-260 osc/min (upper and lower speed limits may vary by 5%). However, at a given setting the speed is constant, and is not affected by normal line voltage fluctuations. The horizontal stroke is fixed at 1.5", and the unit has a max load carrying capacity of 50 lbs. The shaker is supplied without a platform or box carrier. Available accessories include flask holders, separatory funnel holders and a utility box carriers. Or you can double the unit's shaking capacity with the addition of a tiered platform system. As with the larger E5900 unit a digital countdown timer and digital tachometer are available as options.



Stainless Steel Model with Dual Carrier Option

PRODUCT SPECIFICATIONS...

SPECIALTY MODELS:	<ul style="list-style-type: none"> • Low speed version (10 - 50 osc/min), Order No. E6000.01 • High speed version (100 - 400 osc/min), Order No. E6000.02 • Viscous materials shaker with 2" stroke displacement and a higher speed of 98 - 366 osc/min, Order No. E6001.03 • Electronic speed control w\ digital tachometer, digital countdown timer, Order E6003 • Explosion proof, Order No. E6005
OPERATING SPEED:	• Variable speed 60 - 260 osc/min (+/- 5%)
STROKE:	1.5" Horizontal
TYPE OF MOUNTING:	<ul style="list-style-type: none"> • Bench top • Suction cup feet to prevent creeping
LOAD CAPACITY:	Accepts up to 50 lbs
POWER REQUIREMENTS:	115V or 230V, 50Hz or 60Hz Explosion-Proof Unit: 115V 60 Hz or 230V 50 Hz
SIZE AND WEIGHT:	Length: 24.5", Width: 13.5", Height: 10" (without box carrier) Weight: 76 lbs
OPTIONS:	<ul style="list-style-type: none"> • Flask holders of various sizes can be mounted on platforms E6061 (22 1/4" x 12") or E6161 (32" x 20 1/4" if shaking light well balanced loads). Each sold separately. • Dedicated flask carriers are available for shaking 15 x 125 ml (E6060), 15 x 250 ml (E6070) and 15 x 500 ml (E6080) Erlenmeyer flasks • Utility box carrier E6040 with anti-slide surface and one (1) rubber coated crossbar is available to hold various combinations of beakers, flasks, etc. • Stainless Steel Wash-Down models available

DURABILITY • CRAFTSMANSHIP • QUALITY

PRODUCT: | **E6003**

PURPOSE: | **MID-RANGE HEAVY DUTY DIGITAL RECIPROCAL SHAKER**

The E6003 Variable-Speed Mid-Range Reciprocal Shaker is the same as the model E6000 but with digital speed control, digital tachometer and a digital countdown timer with a selector switch for timed or constant operation. The E6003 is powered by a 1/8 hp DC motor which drives the platform through a digital speed controller, speed control is continuously variable between a range of 60-260 osc/minute. The horizontal stroke is fixed at 1.5", and the unit has a max load carrying capacity of 50 lbs. The shaker is supplied without a platform or box carrier. Available accessories include flask holders, separatory funnel holders and a utility box carriers. Or you can double the unit's shaking capacity with the addition of a tiered platform system.



Shown with optional E6040 box carrier

PRODUCT SPECIFICATIONS...

SPECIALTY MODELS:	Stainless Steel model available by request. Call for Quote.
OPERATING SPEED:	Variable speed 60 - 260 osc/min
STROKE:	1.5" Horizontal
TYPE OF MOUNTING:	<ul style="list-style-type: none"> • Bench top • Suction cup feet to prevent creeping
LOAD CAPACITY:	Accepts up to 50 lbs
POWER REQUIREMENTS:	115V or 230V, 50Hz or 60Hz Explosion-Proof Unit: 115V 60Hz or 230V 50Hz
SIZE AND WEIGHT:	Length: 24.5", Width: 13.5", Height: 10" (without box carrier) Weight: 76 lbs
OPTIONS:	<ul style="list-style-type: none"> • Flask holders of various sizes can be mounted on platforms E6061 (22 1/4" x 12") or E6161 (32" x 20 1/4" if shaking light well balanced loads). Each sold separately. • Dedicated flask carriers are available for shaking 15 x 125 ml (E6060), 15 x 250 ml (E6070) and 15 x 500 ml (E6080) Erlenmeyer flasks • Utility box carrier E6040 with anti-slide surface and one (1) rubber coated crossbar is available to hold various combinations of beakers, flasks, etc. • Platform tiering bars available for increased shaking capacity • Stainless Steel Wash-Down models available

Built with Rocker Arm Technology - See Page 34 for details.

DURABILITY • CRAFTSMANSHIP • QUALITY

PRODUCT: | E6010

PURPOSE: | **BENCH TOP FIXED-SPEED RECIPROCAL SHAKER**

Eberbach's Bench top Fixed-Speed Reciprocal Shakers are designed for your lab's general purpose shaking needs. If your sample preparations do not require a variable speed shaker the two speed E6010 is the choice for dependability and longevity. This heavy-duty unit operates in a space of 16.5" x 11" and is powered by a synchronous split phase motor, which drives the platform through a V-belt drive system. Model E6010 is a two-speed unit, operating at either 180 or 280 osc/min (+/- 5%) and controlled by a three position switch. A built in digital countdown timer is available as an option. The E6010 has a horizontal stroke fixed at 1.5", and a maximum load capacity of 40 lbs. Numerous accessories including flask holders, utility box carriers and tiered platform systems (for increasing shaking capacity), are available separately.



Stainless Steel Model With optional Dual Carrier and Stand

PRODUCT SPECIFICATIONS...

OPERATING SPEED:	Variable speed 180 - 280 osc/min
STROKE:	1.5" Horizontal Fixed
TYPE OF MOUNTING:	<ul style="list-style-type: none"> • Bench top • Suction cup feet to prevent creeping
LOAD CAPACITY:	Accepts up to 40 lbs
POWER REQUIREMENTS:	115V 60Hz or 230V, 50/60Hz, 3 wire UL listed power cord
SIZE AND WEIGHT:	Length: 16.5", Width: 11", Height: 10" (without box carrier or stand) Weight: 56 lbs
OPTIONS:	<p>Setup Options</p> <ul style="list-style-type: none"> • Flask holders (E6090) of various sizes can be mounted on platform (E6061) • Utility box carrier with anti-slide surface and one (1) rubber coated crossbar is available to hold various beakers, flasks, bottles, etc. (E6040) • Platform tiering bars available for doubling unit's shaking capacity (E6190/91) • Variable speed with digital tach and timer, Order No. E6013.00 • Stainless Steel Wash-Down models available

Built with Rocker Arm Technology - See Page 34 for details.

DURABILITY • CRAFTSMANSHIP • QUALITY

1-800-422-2558 | WWW.EBERBACHLABTOOLS.COM

PRODUCT: | **E6360**

PURPOSE: | **DIGITAL BENCH TOP RECIPROCAL SHAKER WITH HOTPLATE**

The Hotplate Shaker E6360 is powered by 1/17 hp Bodine DC motor which drives the platform through a filtered PWM controller. The speed is continuously variable between a range of 20-240 osc/min and incorporates a 10" x 16" aluminum hotplate within the box carrier. The heater surface is digitally controlled with 3 distinct settings: 350W (approx 215F), 700W (375F) and 1400W (700F). NOTE: Use of the hotplate requires a power receptacle capable of delivering a minimum of 15 amps at 115 volts. The E6360 Hot Plate Shaker is CE marked.



PRODUCT SPECIFICATIONS...

OPERATING SPEED:	Variable speed 20 - 240 osc/min
STROKE:	1"
TYPE OF MOUNTING:	Floor, with suction cup feet to prevent creeping
LOAD CAPACITY:	Accepts loads up to 40 lbs at low speed 15 lbs at high speed
POWER REQUIREMENTS:	115V, 50/60Hz or 230V, 50/60Hz
SIZE AND WEIGHT:	Length: 20.5", Width: 14.5", Height: 14", (with box carrier) Weight: 25 lbs

PRODUCT:	E6100
PURPOSE:	HEAVY DUTY SIEVE SHAKER

The E6100 Sieve Shaker is a 2 speed shaker designed for quick sample separation. The E6100 utilizes a reciprocating action on the sieve platform enhanced by a vertical acceleration component imparted to the sample through rocker arm linkages thus increasing the efficiency of the separation. A stack of up to eight 2" high sieves (not included), may be used, all being held in place by a simple locking system. This model can be manufactured to hold 6", 8" and 10" sieves. See our website for more sizes. An optional upgrade allows the sieve platforms to accept 2 different sieve sizes.



**E6105 Sieve Shaker (Explosion Proof Model)
is available. Contact us for details**

Built with Rocker Arm Technology - See Page 34 for details.

PRODUCT SPECIFICATIONS...

OPERATING SPEED:	180 or 280 osc/min
TYPE OF MOUNTING:	Suction Feet
LOAD CAPACITY:	40 lbs (6", 8" and 10" Sieves, See website for larger models)
POWER REQUIREMENTS:	115V or 230V, 50/60Hz
POWER CONSUMPTION:	195 Watts
SIZE AND WEIGHT:	Length: 28.5", Width: 20", Height: 30.5" Weight: 76 lbs
OPTIONS:	Call or e-mail for more info on the following options; <ul style="list-style-type: none"> • Can accommodate different sieve types and quantities • Floor stands available • Explosion proof / hazardous location models available E6105.00 • Variable speed available E6103.00 • Stainless steel model available E6100.SS

DURABILITY • CRAFTSMANSHIP • QUALITY

PRODUCT: | **E6205**

PURPOSE: | **EXPLOSION PROOF DOUBLE STACK SIEVE SHAKER**

The E6205 explosion proof sieve shaker is designed to be used in environments made hazardous by explosive vapors or dusts. The reciprocal action of the sieve platform is enhanced by a vertical acceleration component imparted to the sample through rocker arm linkages thus increasing the efficiency of the separation. The shaking speed is 280 osc/min. A 0-99H:99M:99S timer and pilot lamp are included. An optional upgrade allows the sieve platforms to accept 2 different sieve sizes. The final installation of the shaker must be performed by an electrician to insure adherence to local explosion proof codes. The shaker is electrically rated for Class 1, Div 1 groups C,D and Class II, Div 1, groups E,F,G.



E6200 Sieve Shaker (Standard Model) is available.
 Contact us for details

Built with Rocker Arm Technology - See Page 34 for details.

PRODUCT SPECIFICATIONS...



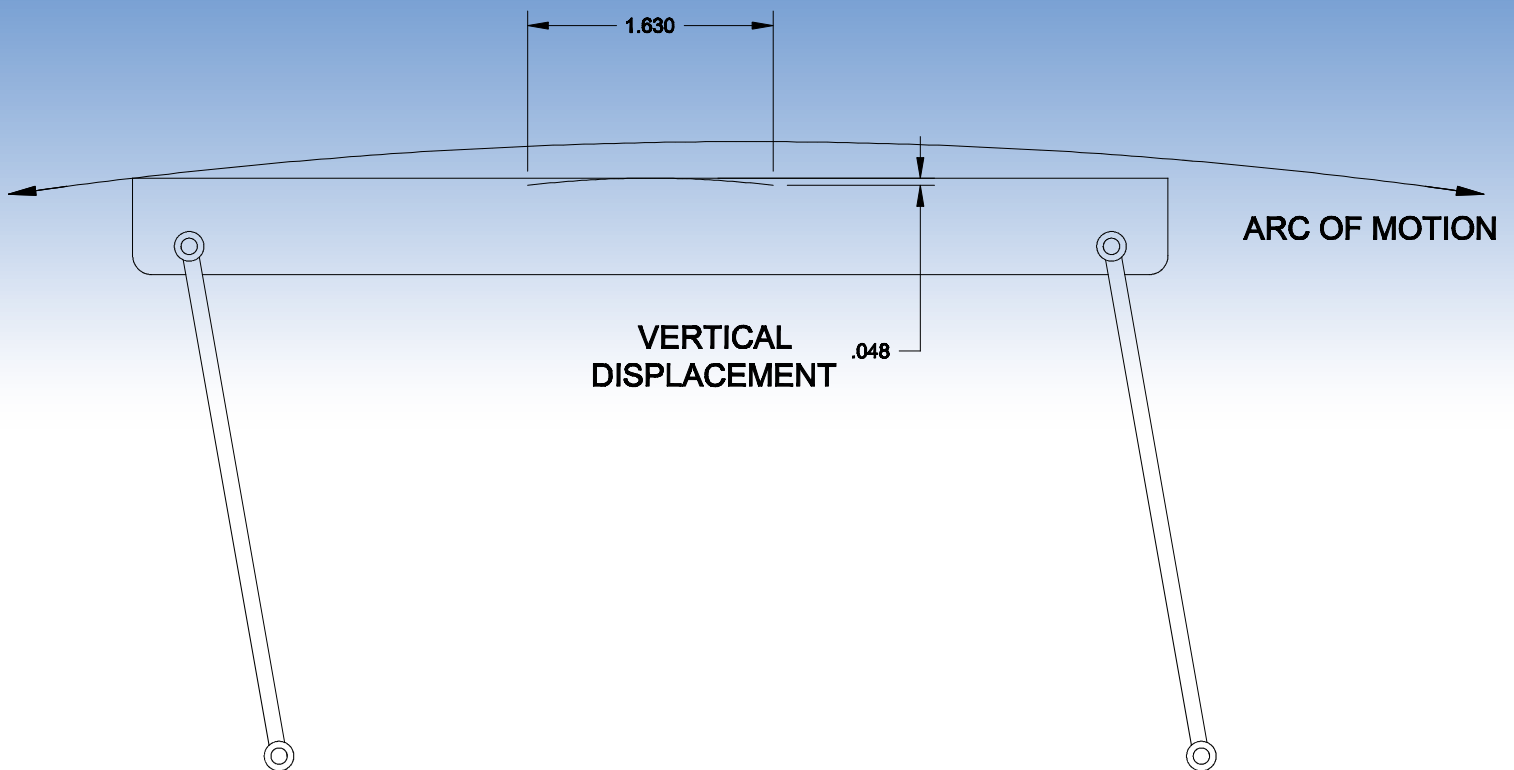

OPERATING SPEED:	280 osc/min
TYPE OF MOUNTING:	Suction Feet
LOAD CAPACITY:	80 lbs (6", 8", 10", 12" and 18" sieves up to 18" high)
POWER REQUIREMENTS:	115V or 230V, 50/60Hz
POWER CONSUMPTION:	195 Watts
SIZE AND WEIGHT:	Length: 39", Width: 20", Height: 10" (without platform) Weight: 140 lbs
OPTIONS:	Call or e-mail for more info on the following options; <ul style="list-style-type: none"> • Can accommodate different sieve types and quantities • Floor stands available • Variable speed available E6203.00 • Count down timer available • Stainless steel model available E6205.SS • Sound enclosure available

What makes Eberbach Reciprocal Shakers with Rocker Arms unique?

Eberbach reciprocating shakers with rocker arms can produce a more aggressive mixing action due to our rocker arm design. Below is a diagram showing our rocker arm design, the rocker arms actually create two axis of motion, a vertical component of motion along with the horizontal axis of motion which produces an arc motion generating a more aggressive agitation than a standard reciprocal shaker. This applies to all E5900, E6000, E6010, E6100 and E6200 series shakers.

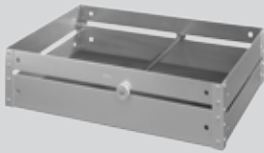

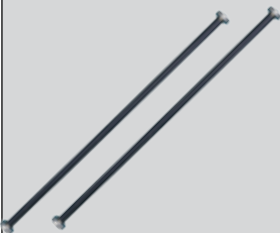
Accessory Image (If Available)	Catalog Number	Description	Compatible Models
	E5910	Large Platform 36" x 24"	E5850
	E5913	Threaded Strip for securing Flask Holders on E5910	E5900
	E5915	Conversion Kit Utility Carrier, Large for 5910 platform	E5900 E5902 E5903
	E5917	Crosswise Bar Clamp, 24"	E5915 E5919
	E5919	Utility Box Carrier 23.86 in x 36 in x 5 in	E5900 E5902 E5903

Accessory Image (If Available)	Catalog Number	Description	Compatible Models	
	E6002	Splash Guard Protects Interior of Shaker From Spills, For Heavy-Duty Shakers E6000 Series	E6000 E6001 E6003 E6004 E6005	
	E6040	Utility Box Carrier 12" x 18" x 4" (includes one 6042 Crosswise Bar Clamp)	E5650 E5850 E6000 E6005 E6010	
	E6042	Crosswise Bar Clamp (for use on E6040 or E5865)	E5850 E6000 E6005 E6010	E6125 E6130 E5650
	E6044	Lengthwise Bar Clamp (for use on E6040)	E6000 E6005 E6010	E5650
	E6046	Vertical Rod with Support	E5850 E6000 E6005 E6010	E6125 E6130 E5650

Accessory Image (If Available)	Catalog Number	Description	Compatible Models	
	E6050	Adaptor to increase shaking capacity of E6000 series shakers by allowing stacking of 2 E6040's	E6000 E6003 E6005 E6010	
	E6060	Flask Carrier, 15-125ml	E5650 E5850 E5900*	E6000 E6005 E6010
	E6061	Carrier Plate, small size, 22.25" x 12"	E5650 E5850 E5900*	E6000 E6005 E6010
	E6070	Flask Carrier, 15-250ml	E5650 E5850 E5900*	E6000 E6005 E6010
	E6080	Flask Carrier, 15-500ml	E5650 E5850 E5900*	E6000 E6005 E6010

* Only if tiered on 5910 platform

Accessory Image (If Available)	Catalog Number	Description	Compatible Models
	E6090	Individual Flask Holders (See chart on page 40)	E5850 E6145 E5900 E6155 E6000 E6125 E6005 E6130 E6010
See chart on page 39	E6095	Individual Separatory Funnel Holders	E5850 E6010 E5900 E6125 E6000 E6130 E6005 E6145 E6155

Shaker Stands



Shaker Series	Compatible Stand
E6010	E6010.A.ST
E6000	E6000.A.ST
E5900	E5900.A.ST
E5902	E5902.A.ST
E6145	E6145.A.ST

Available in Stainless Steel

	E6160	Flask Carrier, 40-125ml	E5900* E6000 E6005
---	-------	-------------------------	--------------------------

* Only if tiered on 5910 platform

Accessory Image (If Available)	Catalog Number	Description	Compatible Models
	E6161	Carrier Plate, Large Size, 32"x20.25"	E5900* E6000 E6005
	E6170	Flask Carrier, 40-250ml	E5900* E6000 E6005
	E6180	Flask Carrier, 30-500ml	E5900* E6000 E6005
	E6190	Tiering Posts, 10" (set of 4)	E5850 E6020 E5900* E6155 E6000 E6145 E6005 E6010
	E6191	Tiering Posts, 6" (set of 4)	E5850 E6010 E5900* E6020 E6000 E6145 E6005 E6155

* Only if tiered on 5910 platform

Erlenmeyer Flask Holders		Carrier Plate Flask Capacity			
Model Number	Flask Size	Large Platform E5910	Large Platform E6165	Small Carrier E6061	Large Carrier E6161
E6090.01	10ml	414	310	116	295
E6090.02	25 ml	216	162	66	160
E6090.05	50 ml	216	162	66	160
E6090.12	125 ml	96	77	28	77
E6090.25	250 ml	60	45	18	40
E6090.50	500 ml	40	30	15	28
E6090.60	1000 ml	32	24	10	24
E6090.65	1500 ml	24	18	8	15
E6090.70	2000 ml	24	18	8	15
E6090.75	2500 ml	12	9	2	12
E6090.78	2800 ml	12	9	3	8
E6090.90	4000 ml	12	9	3	8
E6090.92	6000 ml	12	9	3	8
Separatory Funnel Holders		Separatory Funnel Holder Capacity			
E6095.25	250 ml	18	13	6	15
E6095.50	500 ml	9	7	2	6
E6095.60	1000 ml	8	6	2	6
E6095.70	2000 ml	8	6	2	6



DURABILITY • CRAFTSMANSHIP • QUALITY

Cutting Mills

Eberbach Cutting Mills are designed for continuous duty and ease of use. Multiple hopper options make feeding your sample through the mill hassle free. If you need a specific solution, Eberbach Corporation has the ability to engineer and manufacture the solution.

Eberbach designs and builds Cutting Mills with the following options;

- Stainless Steel, Sanitary and Hazardous location models
- 4 or 6 bladed rotating cutter head
- Data output to HMI and more!



PRODUCT:	E3303
PURPOSE:	VARIABLE SPEED MINI CUTTING MILL

The E3303 Small Benchtop Cutting Mill features a 1.575 inch diameter sealed cutting chamber with two stationary blades and a rotating cutting head with four cutting edges that revolve at high speed to produce a shearing action which minimizes heat build-up.

Samples introduced through the hopper are swept around by the rotor until they are cut to sufficient fineness to pass through sieve. The hard, tool steel cutting edges on the knives allow milling of a wider range of materials, including plastics, animal feed, bones, cables, cardboard, electronic scrap, feed pellets, foils, food, leather, material mixtures, non-ferrous metals, paper, pharmaceutical products, refuse derived fuels, rubber, waste, wood and so much more.

The E3303 is designed with a machine tool type of cartridge spindle, small powerful servo motor which allows for variable speed operation of 0 - 2,400 rpms with high torque. The chamber door comes standard with a door safety switch and the machine has legs to set on top of a benchtop or the legs can be removed and the machine can be bolted directly to a benchtop.



PRODUCT SPECIFICATIONS...

OPERATING SPEED:	0 - 2400 rpm
CHAMBER SIZE:	1.575"
SAMPLE INPUT SIZE:	0.6"
CONTINUOUS TORQUE	1.025 Nm
PEAK TORQUE:	4.125 Nm
ELECTRICAL	115V or 230V @ 50/60hz
SIZE AND WEIGHT:	Length - 17 in Width - 12 in Height - 12 in Weight: 63 lbs
EQUIPMENT OPTIONS:	Call or e-mail for more info on the following options; <ul style="list-style-type: none"> • Stainless Steel, Sanitary and Hazardous location models • Data output to HMI

PRODUCT: | **E3503**

PURPOSE: | **VARIABLE SPEED CUTTING MILL**

The E3503 Medium Benchtop Cutting Mill features a 5 inch diameter sealed cutting chamber with four stationary blades (optional six stationary bladed cutting chamber is available) and a rotating cutting head with four replaceable cutting blades that revolve at high speed to produce a shearing action which minimizes heat build-up.

Samples introduced through the hopper are swept around by the rotor until they are cut to sufficient fineness to pass through sieve. The hard, tool steel cutting edges on the knives allow milling of a wider range of materials, including plastics, animal feed, bones, cables, cardboard, electronic scrap, feed pellets, foils, food, leather, material mixtures, non-ferrous metals, paper, pharmaceutical products, refuse derived fuels, rubber, waste, wood and so much more.

The E3503 is designed with a machine tool type of cartridge spindle, small powerful servo motor which allows for variable speed operation of 0 - 3,000 rpms at 115V and 0 - 5,000 at 230V with high torque. The chamber door comes standard with a door safety switch. The machine comes standard with mounting locations for bolting directly to a benchtop or an optional table top stand or floor stand can be purchased.



Shown with optional Stand

PRODUCT SPECIFICATIONS...

OPERATING SPEED:	<ul style="list-style-type: none"> • 0 - 3000 rpm at 115V • 0 - 5000 rpm at 230V
CHAMBER SIZE:	5.0"
SAMPLE INPUT SIZE:	1.4"
CONTINUOUS TORQUE	4.89 Nm
PEAK TORQUE:	10.6 Nm
ELECTRICAL	Dual Voltage: 115V/230V @ 50/60hz - Optional 3 Phase Mill performance: 115V - Good 230V - Better 230V 3 Phase - Optimal
SIZE AND WEIGHT:	Length - 25 in Width - 20 in Height - 17 in Weight: 254 lbs
EQUIPMENT OPTIONS:	Call or e-mail for more info on the following options; <ul style="list-style-type: none"> • Stainless Steel, Sanitary and Hazardous location models • 6 Stationary Cutting Blade Model • Data output to HMI

PRODUCT: | **E3703**

PURPOSE: | **VARIABLE SPEED HEAVY DUTY CUTTING MILL**

The E3703 Large Benchtop Cutting Mill features a 7.75 inch diameter sealed cutting chamber with six stationary blades and a rotating cutting head with four replaceable cutting blades that revolve at high speed to produce a shearing action which minimizes heat build-up. Samples introduced through the hopper are swept around by the rotating cutting head until they are cut to sufficient size to pass through sieve. The hard, tool steel cutting edges on the knives allow milling of a wider range of materials, including plastics, animal feed, bones, cables, cardboard, electronic scrap, feed pellets, foils, food, leather, material mixtures, non-ferrous metals, paper, pharmaceutical products, refuse derived fuels, rubber, waste, wood and so much more.

The E3703 is designed with a machine tool type of cartridge spindle, a small powerful servo motor which allows for variable speed operation of 0-1,740 rpms at 115V and 0 - 2500 rpm at 230V with high torque. The chamber door comes standard with a door safety switch. The machine comes standard with mounting locations for bolting directly to a benchtop or the machine can be supplied with optional floor stand with castors.



Stainless Steel Model
shown with optional Stand

PRODUCT SPECIFICATIONS...

OPERATING SPEED:	0 - 1740 rpm @ 115V 0 - 2500 @ 230V
CHAMBER SIZE:	7.75"
SAMPLE INPUT SIZE:	2.25"
CONTINUOUS TORQUE	11.6 Nm
PEAK TORQUE:	26.5 Nm
ELECTRICAL	Dual Voltage: 115V / 230V @ 50/60hz - Optional 3 Phase Mill performance: 115V - Good 230V - Better 230V 3 Phase - Optimal
SIZE AND WEIGHT:	Length - 26 in Width - 22 in Height - 22 in Weight: 334 lbs
EQUIPMENT OPTIONS:	Call or e-mail for more info on the following options; <ul style="list-style-type: none"> • Stainless Steel, Sanitary and Hazardous location models • Cutting chamber temp sensor • Tungsten Carbide cutting blades • 6 Bladed Rotating cutter head • Multiple data output options available (IE: Profibus, Ethernet and more)

DURABILITY • CRAFTSMANSHIP • QUALITY

1-800-422-2558 | WWW.EBERBACHLABTOOLS.COM

PRODUCT: | **E3803**

PURPOSE: | **VARIABLE SPEED HEAVY DUTY CUTTING MILL**

The E3803 High-throughput Cutting Mill features a 7.75 inch diameter x 3.9 inch deep sealed cutting chamber (50% deeper than the E3703). The cutting chamber has six stationary blades and two different rotating cutting head options, a four bladed head and a six bladed head (the machine comes standard with the four bladed head) that revolve at high speed to produce a shearing action which minimizes heat build-up and increases throughput. Samples introduced through the hopper are swept around by the rotor until they are cut to sufficient fineness to pass through sieve. The hard, tool steel cutting edges on the knives allow milling of a wider range of materials, including plastics, animal feed, bones, cables, cardboard, electronic scrap, feed pellets, foils, food, leather, material mixtures, non-ferrous metals, paper, pharmaceutical products, refuse derived fuels, rubber, waste, wood and so much more.

The E3803 is designed with a machine tool type of cartridge spindle, small powerful servo motor which allows for variable speed operation of 0-3,000 rpms with extremely high torque. The chamber door comes standard with a door safety switch (auto door option is available upon request) and the machine comes with floor stand with casters.

E3803 is supplied with the following; 1x Plunger, 1x Hopper, 3x Sieves (0.5mm, 1mm & 2mm), 1x Delivery chute extension tube, 1x Tool set, 1x rotating cutter head with 4x rotating blades, 6x stationary cutting blades, and 1x brush.



PRODUCT SPECIFICATIONS...

OPERATING SPEED:	0 - 3000 rpm
CHAMBER SIZE:	7.75"
SAMPLE INPUT SIZE:	3.25"
CONTINUOUS TORQUE	41.4 Nm
PEAK TORQUE:	93.5 Nm
ELECTRICAL	480V
SIZE AND WEIGHT:	Length - 31 in Width - 29 in Height - 50.5 in Weight: 750 lbs
EQUIPMENT OPTIONS:	Call or e-mail for more info on the following options; • Hazardous location models • Data output to HMI

PRODUCT:	E3300, E3500, E3700
PURPOSE:	SINGLE SPEED HEAVY DUTY CUTTING MILLS

E3300 Single Speed Mini Mill:

The E3300 Mini mill is an all steel Benchtop Cutting Mill featuring a 1.575 inch diameter sealed cutting chamber with two adjustable stationary blades and a rotating cutting head with four cutting edges that revolve at high speed to produce a shearing action which minimizes heat build-up. Samples introduced through the hopper are swept around by the rotor until they are cut to sufficient fineness to pass through sieve.

OPERATING SPEED:	1750 rpm
CHAMBER SIZE:	1.575"
SAMPLE INPUT SIZE:	0.6"
TORQUE:	1.03 Nm



E3500 Single Speed Cutting Mill:

The E3500 Mini mill is an all steel Benchtop Cutting Mill featuring a 5 inch diameter sealed cutting chamber with two adjustable stationary blades and a rotating cutting head with four cutting edges that revolve at high speed to produce a shearing action which minimizes heat build-up. Samples introduced through the hopper are swept around by the rotor until they are cut to sufficient fineness to pass through sieve.

OPERATING SPEED:	1750 rpm
CHAMBER SIZE:	5"
SAMPLE INPUT SIZE:	1.4"
TORQUE:	4.12 Nm



E3700 Single Speed Cutting Mill:

The E3700 is designed with a machine tool type of cartridge spindle and a small powerful motor which allows for an operational speed of 920 rpm with high torque. The chamber door comes includes a door safety switch. The machine also comes standard with mounting locations for bolting directly to a benchtop or an optional table top stand or floor stand can be purchased.

OPERATING SPEED:	920 rpm
CHAMBER SIZE:	7.75"
SAMPLE INPUT SIZE:	2.25"
TORQUE:	7.74 Nm



DURABILITY • CRAFTSMANSHIP • QUALITY

PRODUCT: | **E3005**

PURPOSE: | **HAZARDOUS LOCATION GRANULATOR**

The E3005 Hazardous Location Granulator is used for de-clumping of hazardous materials that may catch fire. The heavy duty stainless steel construction is built to withstand high heat substances including substances that may catch fire during the declumping process. Sample is intruced through the hopper and is swept down by the rotating stainless steel rotor which pushes the sample through a sieve. This allows for sample to be uniform when expelled into the heavy duty stainless steel collection bin. The collection bin sits on a steel frame cart with casters for safe and easy removal. Multiple sieve sizes are available. Contact Eberbach for details.



Granulator Chamber and Sieve

PRODUCT SPECIFICATIONS...

OPERATING SPEED:	0 - 30 rpm
SAMPLE INPUT SIZE:	Up to 20 lbs of material. Larger sizes are available upon request.
ELECTRICAL	230V AC 3 Phase
HAZARDOUS CLASSIFICATION:	Electrical explosion resistant to: Class 1 Division 1 Groups C, and D Class 2 Division 1 Groups E, F, and G ATEX specifications are available upon request.
EQUIPMENT OPTIONS:	Call or e-mail for more info on the following options; • Non-Hazardous Granulator • High Volume Granulator • Single or Variable Speed



Stirrers & Tissue Grinders

Eberbach Lab Stirrers and Tissue Grinders are designed for continuous duty and ease of use. Bench top models are built with a hollow spindle and screw chucks to ease stirring jobs by eliminating the need for tools to tighten chucks and allows the user to raise and lower agitator without having to remove it.

If you need a specific solution, Eberbach Corporation has the ability to engineer and manufacture the solution.

Eberbach designs and builds Stirring and Mixing products with the following options;

- Large Volume Mixing / Small Volume Mixing
- Fixed Speed / Variable Speed / High Speed
- High Torque for viscous fluids
- Explosion Proof / Hazardous Duty
- OEM builds



PRODUCT: | E7905

PURPOSE: | HIGH SPEED EXPLOSION PROOF STIRRER

Model E7905 Explosion Proof Stirrer is designed to agitate at high speeds non-viscous materials in environments where explosive gases or dust are present in the air. The E7905 can make use of a variety of agitators and can be customized to customer specific requirements. This includes the design and fabrication of custom agitators and custom torque and speed settings. Explosion resistance classifications can be adjusted based on customer environmental factors. Please note that this unit must be installed by a qualified electrician to preserve their explosion-proof capability.

Please note: 1) This unit must be installed by a qualified electrician to preserve their explosion-proof capability. 2) This unit is supplied with a remote control box which needs to be mounted outside of the hazardous location. 3) Explosion proof control enclosures are available as an option if the stirrer controller is required at the stirrer inside of the hazardous location.

The E7905 can be supplied with a hollow spindle and screw chucks to ease stirring jobs by eliminating the need for tools to tighten chucks and allows the user to raise and lower agitator without having to remove it. Or, the E7905 can be supplied with a key chuck or custom sized spindle chuck to hold agitators for use inside of a hood or in other spaces where there is not overhead space for agitator shaft and therefor is supplied with a key chuck or custom sized spindle chuck to hold agitators. The key chuck is a standard sized chuck that supports up to 3/4" diameter shaft sizes (other sizes available upon request).



Container not included

PRODUCT SPECIFICATIONS...

OPERATING SPEED:	Variable speed range from 230 - 2300 rpm
SIZE AND DIMENSIONS:	Length: 22", Width: 13.5", Height: 30.5" Weight: 150 lbs
TYPE OF MOUNTING:	Bench top Stand
TORQUE:	Max Torque 208 oz-in
POWER REQUIREMENTS:	115V 50/60Hz or 230V 50/60Hz, 3 wire UL listed power cord, 3-Phase Explosion proof
NOTES:	<ul style="list-style-type: none"> • Explosion Proof Standards: Class I Group C&D, Class II Group F & G • Available in stainless steel • Available with higher speeds • Available in larger sizes (for larger volumes) • Available with different mounting options • Non-hazardous location models available

DURABILITY • CRAFTSMANSHIP • QUALITY

PRODUCT: | E7906

PURPOSE: | HIGH TORQUE EXPLOSION PROOF STIRRER

Model E7906 Explosion Proof Stirrer is designed to agitate highly viscous materials in environments where explosive gases or dust are present in the air. The E7906 can make use of a variety of agitators and can be customized to customer specific requirements. This includes the design and fabrication of custom agitators and custom torque and speed settings. Explosion resistance classifications can be adjusted based on customer environmental factors.

Please note: 1) This unit must be installed by a qualified electrician to preserve their explosion-proof capability. 2) This unit is supplied with a remote control box which needs to be mounted outside of the hazardous location. 3) Explosion proof control enclosures are available as an option if the stirrer controller is required at the stirrer inside of the hazardous location.

The E7906 can be supplied with a hollow spindle and screw chucks to ease stirring jobs by eliminating the need for tools to tighten chucks and allows the user to raise and lower agitator without having to remove it. Or, the E7906 can be supplied with a key chuck or custom sized spindle chuck to hold agitators for use inside of a hood or in other spaces where there is not overhead space for agitator shaft and therefor is supplied with a key chuck or custom sized spindle chuck to hold agitators. The key chuck is a standard sized chuck that supports up to 3/4" diameter shaft sizes.



Agitator not included

PRODUCT SPECIFICATIONS...

OPERATING SPEED:	Variable speed range from 30 - 300 rpm
SIZE AND DIMENSIONS:	Length: 22", Width: 13.5", Height: 30.5" Weight: 150 lbs
TYPE OF MOUNTING:	Bench top Stand
TORQUE:	Max Torque 1616 oz-in
POWER REQUIREMENTS:	115V 50/60Hz or 230V 50/60Hz, 3 wire UL listed power cord, 3-Phase Explosion proof
NOTES:	<ul style="list-style-type: none"> • Explosion Proof Standards: Class I Group C&D, Class II Group F & G • Available in stainless steel • Available with higher speeds • Available in larger sizes (for larger volumes) • Available with different mounting options • Non-hazardous location models available

DURABILITY • CRAFTSMANSHIP • QUALITY

PRODUCT: | **E7100**

PURPOSE: | **GENERAL PURPOSE STIRRER**

The model E7100 POWER STIR® is a lower speed, higher torque version of the 7195. It produces a maximum output torque of 96 oz-in at 625 rpm. Speed is variable from 30-625. Both stirrers accept glass, metal or plastic agitators 7/32" thru 5/16" in diameter. Hollow spindle and screw chucks eases stirring jobs by eliminating the need for tools to tighten chucks and allows the user to raise and lower agitator without having to remove it. The standard unit is made of high impact ABS plastic. A version with an aluminum body is also available, please contact us for more information.

PRODUCT SPECIFICATIONS...

OPERATING SPEED:	Speed range from 30 - 625 rpm
MOTOR HP DUTY:	1/17hp DC continuous
MAX CAPACITY:	2 qt heavy syrup
TORQUE:	96 oz-in
POWER REQUIREMENTS:	115V 50/60Hz or 230V 50/60Hz, 3 wire UL listed power cord
DIMENSIONS:	Spindle Height: 7.5", Length: 9", Width: 4", Height: 9"



Shown with optional agitator and stand

PRODUCT: | **E7200**

PURPOSE: | **POWER STIRRER**

The model E7200 UNIVERSAL LAB STIR is a general purpose stirrer powered by a totally enclosed PM motor which features high coercively ceramic magnets and long-life brushes. It has been designed for high torque, reduced weight and size, efficient heat dissipation and continuous operation. The 1/17 hp motor produces 24 oz-in of torque at 2500 rpm. Speed is variable from 100-2500 rpm. Hollow spindle and screw chucks eases stirring jobs by eliminating the need for tools to tighten chucks and allows the user to raise and lower agitator without having to remove it. The standard unit is made of high impact ABS plastic. A version with an aluminum body is also available, please contact us for more information.

PRODUCT SPECIFICATIONS...

OPERATING SPEED:	Speed range from 100 - 2500 rpm
MOTOR HP DUTY:	1/17hp DC continuous
MAX CAPACITY:	2 qt heavy syrup / 5 gal aqueous
TORQUE:	24 oz-in
POWER REQUIREMENTS:	115V 50/60Hz or 230V 50/60Hz, 3 wire UL listed power cord
DIMENSIONS:	Spindle Height: 7.5", Length: 9", Width: 4", Height: 9"



Shown with optional agitator and stand

PRODUCT: | E7113
PURPOSE: | HIGH TORQUE STIRRER

The Model E7113 High Torque stirrer is designed for applications that involve mixing of viscous substances. Built with a durable aluminum frame which houses a powerful motor capable of producing 200 oz-in of torque at all speed ranges. A digital controller allows the programming of timed operations along with easy speed control and a pulsing option. Hollow spindle and screw chucks eases stirring jobs by eliminating the need for tools to tighten chucks and allows the user to raise and lower agitator without having to remove it.

PRODUCT SPECIFICATIONS...

OPERATING SPEED:	20 - 625 rpm
SPEED ACCURACY:	+/- 1 rpm
CONTINUOUS TORQUE:	200 oz-in
PEAK TORQUE:	1000 oz-in
POWER REQUIREMENTS:	115V 50/60Hz or 230V 50/60Hz
DIMENSIONS:	Length: 14", Width: 5.5", Height: 10.6"



Shown with optional agitator and stand

PRODUCT: | E7123
PURPOSE: | HIGH TORQUE STIRRER

The Model E7123 High Torque stirrer is designed for applications that involve mixing of highly viscous substances. Built with a durable aluminum frame which houses a powerful Bodine motor capable of producing 404 oz-in of continuous torque. A digital controller allows the programming of timed operations along with easy speed control and a pulsing option. Hollow spindle and screw chucks eases stirring jobs by eliminating the need for tools to tighten chucks and allows the user to raise and lower agitator without having to remove it.

PRODUCT SPECIFICATIONS...

OPERATING SPEED:	20 - 625 rpm
SPEED ACCURACY:	+/- 1 rpm
CONTINUOUS TORQUE:	404 oz-in
PEAK TORQUE:	600 oz-in
POWER REQUIREMENTS:	115V 50/60Hz or 230V 50/60Hz
DIMENSIONS:	Length: 14", Width: 5.5", Height: 10.6"



Shown with optional agitator and stand

DURABILITY • CRAFTSMANSHIP • QUALITY

1-800-422-2558 | WWW.EBERBACHLABTOOLS.COM

PRODUCT: | E7213

PURPOSE: | HIGH SPEED STIRRER

Model E7213 universal lab stirrer is designed for high speed stirring. The aluminum frame allows for efficient heat dissipation and continuous operation. The E7213 Stirrer motor produces 50 oz-in of continuous torque. Speed is variable from 100-2500 rpm. Hollow spindle and screw chucks eases stirring jobs by eliminating the need for tools to tighten chucks and allows the user to raise and lower agitator without having to remove it.

PRODUCT SPECIFICATIONS...

OPERATING SPEED:	100 - 2500 rpm
SPEED ACCURACY:	+/- 1 rpm
CONTINUOUS TORQUE:	50 oz-in
PEAK TORQUE:	250 oz-in
POWER REQUIREMENTS:	115V 50/60Hz or 230V 50/60Hz
DIMENSIONS:	Length: 14", Width: 5.5", Height: 10.6"



Shown with optional agitator and stand

PRODUCT: | E7223

PURPOSE: | HIGH SPEED STIRRER

The Model E7223 universal lab stirrer is the strongest of the high speed stirring line. Utilizing a high powered Bodine motor, the E7223 Stirrer can output 101 oz-in of continuous torque. Built with durability in mind, the E7223 has an aluminum frame which also allows for efficient heat dissipation and continuous operation. A digital controller allows for timed operations and easy speed control, including a "pulse" ability. Hollow spindle and screw chucks eases stirring jobs by eliminating the need for tools to tighten chucks and allows the user to raise and lower agitator without having to remove it.

PRODUCT SPECIFICATIONS...

OPERATING SPEED:	100 - 2500 rpm
SPEED ACCURACY:	+/- 1 rpm
CONTINUOUS TORQUE:	101 oz-in
PEAK TORQUE:	150 oz-in
POWER REQUIREMENTS:	115V 50/60Hz or 230V 50/60Hz
DIMENSIONS:	Length: 14", Width: 5.5", Height: 10.6"



Shown with optional agitator and stand

PRODUCT: | **E7225**

PURPOSE: | **CON-TORQUE STIRRER**

The model E7225 Con-Torque Stirrer is suitable for continuous duty stirring of highly viscous materials. A 1/9 hp motor and gear drive produces 196 oz-in of continuous torque which drives the hollow spindle through a speed range of 0 to 700 rpm.



Shown with optional stand (E7560)
and agitator

PRODUCT SPECIFICATIONS...

OPERATING SPEED:	Speed range from 0 - 700 rpm
MOTOR HP DUTY:	1/9hp continuous
MAX CAPACITY:	2 gal heavy syrup
TYPE OF MOUNTING:	Integral clamp fits on support rods up to 3/4" in diameter
TORQUE:	196 oz-in of continuous torque at all speeds
DIMENSIONS:	Spindle Height: 7", Length: 11", Width: 9", Height: 7"
POWER REQUIREMENTS:	115V 50/60Hz or 230V 50/60Hz, 3 wire UL listed power cord
ORDER OPTIONS:	<ul style="list-style-type: none"> • Numerous stirring shafts, propellers, blades, clamps, supports, available as accessories for overhead stirrers (see Stirrer Accessory page for details) • Universal Support Stand, Order E7560

PRODUCT: | E2355
PURPOSE: | CON-TORQUE TISSUE HOMOGENIZER

Now you can homogenize tissue effortlessly for culture work as well as pathology and biological study. Eberbach's variable-speed Con-Torque Tissue Homogenizer gives 196 oz-in of continuous torque at all speeds providing continuous, effortless, positive grinding action. Full torque eliminates the possibility of tissue jamming the pestle in the grinding vessel. A totally enclosed, fan cooled 1/9 hp motor drives the Con-Torque power unit through a continuously variable transmission. Speeds from 0 to 400 rpm are selected by a lockable lever. Sintered bronze motor bearings require no lubrication. A 3/8" output shaft provides rotation for the chuck through a flexible coupling allowing operation at various angles which reduces breakage of glassware. A knurled hand-wheel offers a counter support grip when tightening the chuck which accepts shafts up to 1/2" in diameter. A 3/8" fixed coupling is included for techniques requiring application of side pressure to pestle and mortar. An integral clamp fits on support rods up to 3/4" in diameter. Eberbach's Tissue Homogenizer comes complete with Con-Torque power unit, chucking device and universal support, but without mortar or pestle.



Pestle Not Included

PRODUCT SPECIFICATIONS...

OPERATING SPEED:	Speed range from 0 - 400 rpm
CHUCK CAPACITY:	O.D. to 1/2"
UNIT OPTIONS INSTALLED:	1/2" screw chuck, hand wheel, flexible and fixed couplings
TYPE OF MOUNTING:	Integral clamp fits on support rods up to 3/4" in diameter
TORQUE:	196 oz-in of continuous torque at all speeds
DIMENSIONS:	Length: 15", Width: 13.5", Height: 35" (with stand)
POWER REQUIREMENTS:	115V 50/60Hz or 230V 50/60Hz, 3 wire UL listed power cord
ORDER OPTIONS:	<ul style="list-style-type: none"> • Homogenizer unit without support stand, Order E2360 • Spare Flexible coupling, Order E2380 • Spare chuck, Order E2370 • Spare Universal Support Stand, Order E7560

PRODUCT: | **E7000**
PURPOSE: | **TISSUE HOMOGENIZER POWER UNIT**

The model E7000 incorporates the E7085 stirrer as the drive unit for the tissue homogenizer. The unit is designed for use with Potter-Elvehjem style tissue grinders. A chuck holds pestles with shafts up to 3/8" in diameter. Speed varies from 30-625 rpm (max torque 96 oz-in). The standard unit is made of high impact ABS plastic. A version with an aluminum body is also available, please contact us for more information.



Pestle and Stand Not Included

PRODUCT SPECIFICATIONS...

OPERATING SPEED:	Speed range from 30 - 625 rpm
CHUCK CAPACITY:	O.D. to 3/8"
UNIT OPTIONS INSTALLED:	3/8" screw chuck, hand wheel, flexible and fixed couplings
TYPE OF MOUNTING:	Integral clamp fits on support rods up to 3/4" in diameter
TORQUE:	96 oz-in
POWER REQUIREMENTS:	115V 50/60Hz or 230V 50/60Hz, 3 wire UL listed power cord
ORDER OPTIONS:	<ul style="list-style-type: none"> • Numerous stirring shafts, propellers, blades, clamps, supports, available as accessories for overhead stirrers (see Stirrer Accessory page for details) • Spare Flexible coupling, Order E2380 • Spare Universal Support Stand, Order E7560

PRODUCT: | **E7013**

PURPOSE: | **LOW SPEED HIGH TORQUE TISSUE GRINDER**

The Model E7013 Tissue Grinder is designed for use with Potter-Elvehjem style tissue grinders. A chuck holds pestles with shafts up to 3/8" in diameter. Speed varies from 20-625 rpm (peak torque 1000 oz-in). The standard unit is made of aluminum to prevent corrosion while providing a durable frame.



Pestle and Stand Not Included

PRODUCT SPECIFICATIONS...

OPERATING SPEED:	Speed range from 20 - 625 rpm
CHUCK CAPACITY:	O.D. to 3/8"
UNIT OPTIONS INSTALLED:	1/2" screw chuck, hand wheel, flexible and fixed couplings
TYPE OF MOUNTING:	Integral clamp fits on support rods up to 3/4" in diameter
PEAK TORQUE:	1000 oz-in
PERMISSIBLE RELATIVE HUMIDITY	80%
POWER REQUIREMENTS:	115V 50/60Hz or 230V 50/60Hz
DIMENSIONS:	Length: 14", Width: 5.5", Height: 10.6" (without stand) Weight: 17 lbs
ORDER OPTIONS:	<ul style="list-style-type: none"> • Foot pedal power control • Universal Support Stand, Order E7560

PRODUCT: | E7023

PURPOSE: | HIGH SPEED MEDIUM TORQUE TISSUE GRINDER

The E7023 digital Tissue Grinder is designed for use with Potter-Elvehjem style tissue grinders. A chuck holds pestles with shafts up to 3/8" in diameter. Speed varies from 100-2,500 rpm (peak torque 150 oz-in). The standard unit is made of aluminum to prevent corrosion while providing a durable frame.

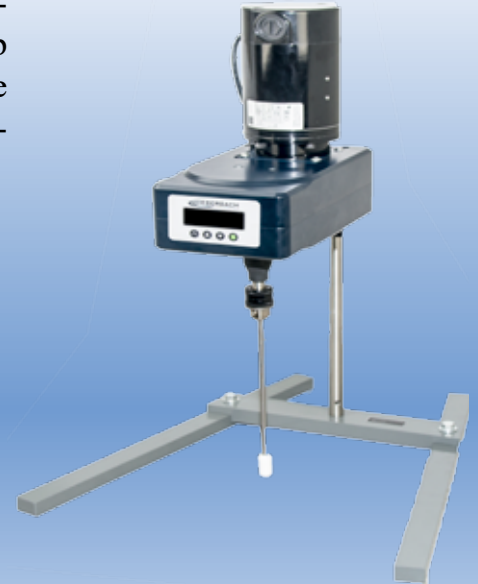

Pestle and Stand Not Included

PRODUCT SPECIFICATIONS...

OPERATING SPEED:	Speed range from 100 - 2500 rpm
CHUCK CAPACITY:	O.D. to 3/8"
UNIT OPTIONS INSTALLED:	1/2" screw chuck, hand wheel, flexible and fixed couplings
TYPE OF MOUNTING:	Integral clamp fits on support rods up to 3/4" in diameter
PEAK TORQUE:	150 oz-in
PERMISSIBLE RELATIVE HUMIDITY	80%
POWER REQUIREMENTS:	115V 50/60Hz or 230V 50/60Hz
DIMENSIONS:	Length: 14", Width: 5.5", Height: 10.6" (without stand) Weight: 27 lbs
ORDER OPTIONS:	<ul style="list-style-type: none"> • Foot pedal power control • Universal Support Stand, Order E7560

DURABILITY • CRAFTSMANSHIP • QUALITY

PRODUCT: | E7033
PURPOSE: | LOW SPEED HIGH TORQUE TISSUE GRINDER

The E7033 tissue homogenizer is designed for use with Potter-Elvehjem style tissue grinders. A chuck holds pestles with shafts up to 1/2" in diameter. Speed varies from 30 - 625 rpm (peak torque 600 oz-in). The standard unit is made with an aluminum anodized housing.





Pestle and Stand Not Included

PRODUCT SPECIFICATIONS...

OPERATING SPEED:	Speed range from 30 - 625 rpm
CHUCK CAPACITY:	O.D. to 3/8"
UNIT OPTIONS INSTALLED:	1/2" screw chuck, hand wheel, flexible and fixed couplings
TYPE OF MOUNTING:	Integral clamp fits on support rods up to 3/4" in diameter
PEAK TORQUE:	600 oz-in
PERMISSIBLE RELATIVE HUMIDITY	80%
POWER REQUIREMENTS:	115V 50/60Hz or 230V 50/60Hz
DIMENSIONS:	Length: 14", Width: 5.5", Height: 10.6" (without stand) Weight: 27 lbs
ORDER OPTIONS:	<ul style="list-style-type: none"> • Foot pedal power control • Universal Support Stand, Order E7560

Image	Description	Catalog number
	Eberbach Labtools E7400 Stirring Rod-Stainless Steel <ul style="list-style-type: none"> • Steel Stirring Rod • Blades riveted onto 1/4" shafts • Blade pitch can be adjusted to control agitation • 18" and 24" lengths recommended for Hollow Spindle Stirrers • Lengths: 6", 9", 12", 18", 24" 	E7400
	Eberbach Labtools E7420 Shafts-Stainless Steel <ul style="list-style-type: none"> • Stainless Steel Shaft, 5/16" dia with 8" flatted section for securing E7430 or E7440 • Specify length: 18", 24" or 36" 	E7420
	Eberbach Labtools E7430 Propeller <ul style="list-style-type: none"> • Stainless Steel Propeller, 5/16" bore, 2-1/4" OD • Complete with wrench 	E7430
	Eberbach Labtools E7440 4 Blade Turbine <ul style="list-style-type: none"> • Stainless Steel Turbine, 4-blade, 5/16" bore, 2-1/2" OD • Complete with wrench 	E7440
	Eberbach Labtools E7460 Swinging Blade Stirring Rod <ul style="list-style-type: none"> • Swinging Blade Stirring Rod in Stainless Steel, 24" length, 5/16" diameter • Fits standard round bottom flasks; tilts to pass through flask neck • Specify size of flask: 500 ml, 1000 ml or 2000 ml 	E7460

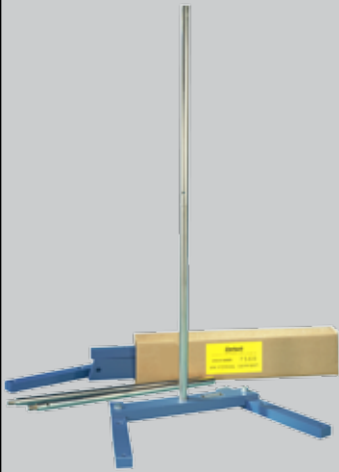
Image	Description	Catalog number
	<p>Eberbach Labtools E7470 Glass Stirring Rod</p> <ul style="list-style-type: none"> • Glass Stirring Rod, 24" length • 5/16" dia shaft, has 1-3/4" diameter two-blade propeller (5/8" wide) • Deep pitch; for Hollow Spindle stirrers 	E7470
	<p>Eberbach Labtools E7540 Custom Stirrer Clamp</p> <ul style="list-style-type: none"> • Split-type clamp allows support at any angle to the horizon • Accepts 1/2" dia stirrer arm in split lock • Mounts on support rods up to 3/4" dia. 	E7540
	<p>Eberbach Labtools E7560 Universal Support</p> <ul style="list-style-type: none"> • 3/4" dia x 34" L 2 section nickel-plated steel support is mounted in iron base • Base has 5 threaded holes for convenient rod placement • Breaks down into compact unit • Package size 18-1/2" x 4" x 2" • Larger bases available, call for details • Units available in all stainless steel <p>Larger bases available to accomodate various cylinder sizes</p> <ul style="list-style-type: none"> • E7560.18 - Accomdates up to 21" diameter cylinders • E7560.26 - Accomdates up to 32" diameter cylinders • E7560.34 - Accomdates up to 43" diameter cylinders <p>Eberbach Labtools E7565 Support Rod, Order No. E7565</p> <ul style="list-style-type: none"> • 3/4" x 17" support rod • Allows for expanding E7560 Universal Support to desired height 	E7560

Blenders

Eberbach carries a full line of laboratory blenders, specialty blending containers and blending assemblies for all your blending needs. If you have a blending, homogenizing or sample reduction application and you don't see the product you need, Eberbach can design and build a blending, grinding, homogenizing or milling product to meet your specific application needs. Please inquire for more information.



DURABILITY • CRAFTSMANSHIP • QUALITY

1-800-422-2558 | WWW.EBERBACHLABTOOLS.COM

PRODUCT: | **E8016**
PURPOSE: | **HEAVY DUTY BLENDER POWER UNIT**

Eberbach's E8016 Blender is designed for heavy duty use in environments where explosive gasses are not present. Powered by a 1.5 hp AC motor the blender speed can be varied between 1150-11500 rpm. Speed is indicated by a tachometer readout on the motor speed controller. Designed to accommodate a waring 4-liter blending container the E8016 can also use all of Eberbach's 1 liter and smaller containers with the addition of the E8051 container adapter (not included).



Shown with optional E8051 container adaptor and E8442 Container

PRODUCT SPECIFICATIONS...

BLENDING SPEED:	1150-11500 rpm
BLENDING MOTOR:	1.5 HP Leeson 3 phase
POWER REQUIREMENTS:	<ul style="list-style-type: none"> • Model E8016: 120V, 50/60Hz, single phase • Model E8016.25: 240V, 50/60Hz, single phase
OPTION POWER REQUIREMENTS:	<ul style="list-style-type: none"> • 230/460 V, 50/60 Hz three phase, Order No. E8017.25 • 230V, 50/60 Hz, three phase, Order No. E8018.25
SIZE AND WEIGHT:	Length: 20.5", Width: 16", Height: 18" without container Weight: 100 lbs

PRODUCT: | E8017

PURPOSE: | EXPLOSION PROOF BLENDER

Eberbach’s single speed Electrically Explosion-Proof Blender E8017 is designed for laboratory situations made hazardous by the blending of mixtures containing volatile solvents. Unit features a 1.5 hp explosion-proof motor with automatic reset thermal protection. The E8017 is designed to accommodate a Waring® 4-Liter blending container (E8020 not included). The explosion-proof motor is UL approved (applies to motor only) for Class I, Group C and D and Class II, Group F and G operation. It will provide constant torque in a fixed speed of 11,500 rpm. The E8017 is designed to use a 4-Liter container, but you can use an adapter unit to fit all Eberbach blending containers with the use of a Model E8051 adapter. The Model E8017 must be installed by a qualified electrician to preserve their explosion-proof capability. The Model E8017.XP comes equipped with an explosion proof plug. Units are supplied without container or adapter, these can be purchased as an option.



E8017.XP with Plug and optional E8020 blending container

PRODUCT SPECIFICATIONS...

BLENDING SPEED:	Fixed @ 11500 rpm
BLENDING MOTOR:	Explosion - proof single phase UL approved for Class I, Group C, D and Class II Group F and G. Rated 1.5 hp
POWER REQUIREMENTS:	115/230V, 60Hz, 16.4/8.3Amps
OPTION POWER REQUIREMENTS:	230/460 V, 50/60 Hz three phase, Order No. E8017.25
SIZE AND WEIGHT WITHOUT CONTAINER:	Length 20.4”, Width: 10.4”, Height: 18” Weight: 115 lbs

PRODUCT:	E8018
PURPOSE:	EXPLOSION PROOF BLENDER

Eberbach’s variable speed Explosion-Proof Blender E8018 is designed for laboratory situations made hazardous by the blending of mixtures containing volatile solvents. Unit features a 1.5 hp explosion-proof motor with automatic reset thermal protection. The E8018 is designed to accommodate a Waring® 4-Liter blending container (E8020 not included). The explosion-proof motor is UL approved (applies to motor only) for Class I, Group C and D and Class II, Group F and G operation. It will provide constant torque in a speed range from 1,150 to 11,500 rpm. Blender is powered by a PWM scalar drive and speed is monitored by a digital display. The E8018 is designed to use a 4-Liter container, but you can use an adapter unit to fit all Eberbach blending containers with the use of a Model E8051 adapter. The Model E8018 must be installed by a qualified electrician to preserve their explosion-proof capability. Units are supplied without container or adapter, these can be purchased as an option



Shown with optional E8020
blending container

PRODUCT SPECIFICATIONS...

BLENDING SPEED:	Variable between 1150 - 11500 rpm
BLENDING MOTOR:	Explosion-proof three phase UL approved for Class I, Group C, D and Class II Group F and G. Rated 1.5 hp
POWER REQUIREMENTS:	230V, 50/60Hz, 6.2 Amps
OPTION POWER REQUIREMENTS:	230V, 50/60 Hz, three phase, Order No. E8018.25
SIZE AND WEIGHT WITHOUT CONTAINER:	Length 20.4”, Width: 10.4”, Height: 18” Weight: 115 lbs

PRODUCT: | E8000
DESCRIPTION: | WARING® BLENDER, 4 LITER & CONTAINER

Model E8000 Waring® blender, 4-liter & container. Heavy-duty 3hp motor with three running speeds of 16K, 18K, 20K rpm and Pulse. Complete with 1 gallon/4L working capacity stainless steel container and Stainless steel blending assembly with high performance ball bearings.

PRODUCT SPECIFICATIONS...

BLENDING SPEEDS:	16K, 18K, 20K rpm and Pulse
MOTOR HP DUTY:	3.75hp
CONTAINER:	Stainless steel with 1 gal (4L) working capacity
BLENDING ASSEMBLY:	Stainless steel with high performance ball bearings
POWER REQUIREMENTS:	115V 50/60Hz or 230V 50/60Hz, 15 amps
ORDER OPTIONS:	<ul style="list-style-type: none"> • Waring® Blender Power Unit Only, 4-Liter Order No. E8010 - Same as Model 8000 without container • Waring® 4-Liter Blending Container Order No. E8020 - As supplied with Model 8000 Blender • Waring® 4-Liter Container, Cool Base Order No. E8025 - 4-Liter, without cover • Waring® 4-Liter Container Covers • For Model E8020/E8025, Order No. E8030 • With pinhole, Order No. E8035

PRODUCT: | E8070
DESCRIPTION: | WARING® BLENDER POWER UNIT, 2 LITER

Model E8070 Waring® blender power unit, 2-liter. Stainless steel motor housing with a heavy duty 1 hp motor that runs at 2 run speeds: 19000 & 23000 rpm. This unit comes complete with stainless steel container and 2 piece vinyl lid.

PRODUCT SPECIFICATIONS...

BLENDING SPEEDS:	19K and 23K rpm
MOTOR HP DUTY:	1hp - 2speed
CONTAINER:	Stainless steel container with 2 piece vinyl lid
BLENDING ASSEMBLY:	Stainless steel motor housing
POWER REQUIREMENTS:	115V 50/60Hz or 230V 50/60Hz, 7.5 amps
ORDER OPTIONS:	<ul style="list-style-type: none"> • Waring® 2-Liter Autoclavable Blending Container Order No. E8075 - Two liter blending container with stainless steel lid suitable for autoclaving.

DURABILITY • CRAFTSMANSHIP • QUALITY

PRODUCT: | E8100
DESCRIPTION: | WARING® BLENDER, 1-SPEED, WITH 1L GLASS CONTAINER

Model E8100 Waring® blender, single-speed, with 1-liter glass container. The unit has a 0.4 hp ball bearing motor, mounted on rubber cushions and runs at free spin speed of 22000 rpm. The unit can process up to 0.6-liters of material with high liquid content in heat resistant glass container. Includes standard blending assembly & 2-piece vinyl cover with a total overall unit height of 15-1/4”.

PRODUCT SPECIFICATIONS...

BLENDING SPEEDS:	Free spin speed of 22000 rpm
MOTOR HP DUTY:	0.4 hp ball bearing motor
CONTAINER:	Process up to 0.6-Liters of material with high liquid content in heat resistant glass container
BLENDING ASSEMBLY:	Includes standard blending assembly & 2-piece vinyl cover
POWER REQUIREMENTS:	Order No. E8100, 115V, 50/60Hz Order No. E8100.20, 230V, 50/60Hz
ORDER OPTIONS:	<ul style="list-style-type: none"> • Waring® Blender, Single-Speed Base Only Order No. E8400, 115V, 50/60Hz Order No. E8400-20, 230V, 50/60Hz Like Model E8100 w/o container

PRODUCT: | E8120
DESCRIPTION: | WARING® BLENDER, 2-SPEED, WITH 1L GLASS CONTAINER

Model E8120 Waring® blender, 2-speed, with 1-liter glass container. The unit has a 0.4 hp ball bearing motor, mounted on rubber cushions and runs at 2 speeds of 18000 and 22000 rpm. The unit can process up to 0.6-liters of material with high liquid content in heat resistant glass container. Includes standard blending assembly & 2-piece vinyl cover with a total overall unit height of 15-1/4”.

PRODUCT SPECIFICATIONS...

BLENDING SPEEDS:	Free spin speed of 22000 and 18000 rpm
MOTOR HP DUTY:	0.4 hp ball bearing motor
CONTAINER:	Process up to 0.6-Liters of material with high liquid content in heat resistant glass container
BLENDING ASSEMBLY:	Includes standard blending assembly & 2-piece vinyl cover
POWER REQUIREMENTS:	Order No. E8120, 115V, 50/60Hz Order No. E8120.20, 230V, 50/60Hz
ORDER OPTIONS:	<ul style="list-style-type: none"> • Waring® Blender, 2-Speed, 1 Liter Glass Container and Heavy Duty Motor Order No. 8122 2 speed with heavy duty motor - 0.7 peak HP



PRODUCT: | E8130
DESCRIPTION: | WARING® BLENDER, 2-SPEED/TIMER, GLASS CONTAINER

Model E8130 Waring® blender, 2-speed, with 1-liter glass container. The unit has a 0.4 hp ball bearing motor, mounted on rubber cushions and runs at 2 speeds of 18000 and 22000 rpm. The unit can process up to 0.6-liters of material with high liquid content in heat resistant glass container. Includes standard blending assembly & 2-piece vinyl cover with a total overall unit height of 15-1/4”.

PRODUCT SPECIFICATIONS...

BLENDING SPEEDS:	Free spin speed of 18000 and 22000 rpm
MOTOR HP DUTY:	0.4 hp ball bearing motor
CONTAINER:	Process up to 0.6-Liters of material with high liquid content in heat resistant 1L glass container
BLENDING ASSEMBLY:	Includes standard blending assembly & 2-piece vinyl cover
POWER REQUIREMENTS:	Order No. E8130, 115V, 50/60Hz Order No. E8130-20, 230V, 50/60Hz

PRODUCT: | E8150
DESCRIPTION: | WARING® BLENDER, VARIABLE SPEED 0-20000 RPM

Model E8150 Waring® Blender is built with a 0.4 hp solid state controlled motor which provides variable speed from 0-20000 rpm. A Stainless Steel Container is also included with the purchase of this unit.

PRODUCT SPECIFICATIONS...

BLENDING SPEEDS:	Variable speed 0-20000 rpm
MOTOR HP DUTY:	0.4 hp blender with solid state controlled motor
CONTAINER:	Included E8505 Stainless Steel Container
BLENDING ASSEMBLY:	Includes standard blending assembly
POWER REQUIREMENTS:	Order No. E8150, 115V, 50/60Hz



BLENDING ASSEMBLIES

Standard Size Blending Assembly

Order No. E8670

- As supplied with blending containers E8440, E8442, E8490, E8500, E8510 and E8520.
- Assembly has S/S blades
- Blade diameter is 2-3/8"

All Stainless Steel, Standard Size Blending Assembly, Order No. E8672

- Like 8670, but ALL stainless steel blades, bearing holder, shaft, bearing cap and cap nut

Small Size Blending Assembly, Order No. E8710

- As supplied w/ E8470 and E8495 containers
- Overall diameter of stainless blades 1-7/8"

All Stainless Steel, Small Size Blending Assembly, Order No. E8712

Semi-micro Blending Assembly, Order No. E8730

- As supplied with blending containers E8485, E8580, E8581 and E8590
- Overall diameter of stainless steel blades 15/16"

All Stainless Steel, Semi micro Blending Assembly, Order No. E8732

Eberbach Labtools Centrifugal-Flow Blending Assembly, Order No. E8650.

- Stator, rotator configuration of this blending assembly forces the flow of liquids through cutting blades, causing efficient cell and tissue homogenization via high speed mechanical disruption.
- May be used for emulsification of non-miscible liquids, re-suspension of slurries and, at lower speeds, general mixing with minimal aeration of sample.
- May be used in all standard, small or semi-micro blending containers. All metal components are made of stainless steel.
- For use with Waring or Eberbach blending containers.

Sealed Blending Assemblies

In order to minimize leakage of sample solution through the drive shaft/bearing interface we have added a nitrile seal below the bearing cap. Positive pressures to 32 psi may be held for extended periods thus allowing the introduction of controlled atmospheres into the container. These sealed assemblies may be used in all Eberbach and Waring containers.

Standard size, Order No. E8671

Small size, Order No. E8711

Semi-micro size, Order No. E8731

Standard size all S/S, Order No. E8673

Small size all S/S, Order No. E8713

Semi-micro size all S/S, Order No. E8733

Replacement seal, Order No. E8734

Waring® 4-Liter Blending Assembly, Order No. E8660

- Less washer and lock nut; for E8020 Waring 4-Liter container. Suitable for aqueous blending applications.

Harsh Condition 4-Liter Blending Assembly, Order No. E8661

- Less washer and lock nut. Suitable when using liquids that would otherwise attack the nitrile. Seals of the standard 4-liter assemblies.

Conventional Blending Assemblies are supplied with many Waring® and Eberbach blending containers. Blades are stainless steel and vary in size and shape depending on the type and size of the container. Other metal parts in contact with sample material are of corrosion resistant chromium plated brass. Wrench set (Order No. E8770) is designed for easy blending assembly removal and installation. Stainless Steel Blending Assemblies are for use with highly corrosive sample materials or where metal ion contamination adversely affects sample preparations. All metal surfaces are of stainless steel. The blending assembly washers are Teflon®. The bearing is pure carbon.



4-Liter Blending Assembly
Assembly No. E8660

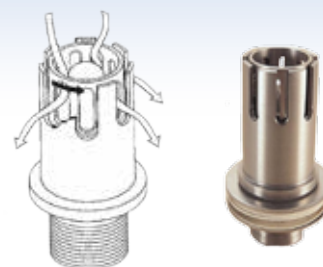

Homogenizing Blending
Assembly No. E8650

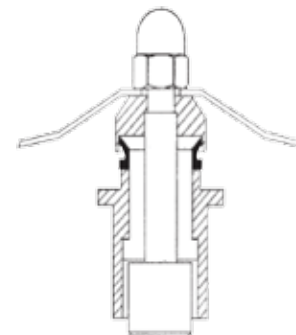

Sealed Blending Assembly
Assembly No. E8671









Image	Description	Autoclavable	Catalog number
	Glass Container w/1-Piece Acrylic Cover. 1-Liter container with working maximum of 500 ml and minimum of 75 ml. This heat resistant glass container measures 8”H x 4-2/4” dia at top. Contains a standard blending assembly (E8670). Fits Waring power units.	No	E8440
	Glass Container w/2-Piece Vinyl Cover. Like #8440 but 1150 ml container with glass handle. Unit measures 8-5/8” x 5” diameter at the top. Contains a standard blending assembly (E8670). Fits Waring power units.	No	E8442
	Small Glass Container w/Metal Screw Cover. 500 ml container with working maximum of 250 ml and minimum of 30 ml. This Borosilicate glass container measures 6-1/2”H x 3-3/4” diameter at the top. Contains a small size blending assembly (E8710). Fits Waring power units.	Yes	E8470
	Polypropylene container (2”D x 2”W x 4”H) is easily replaced with removal of one nut. Replacement container E8585.002. The 150ml container has a working maximum of 100ml and a minimum of 50ml. Contains a semi-micro blending assembly.	Yes	E8485
	Blender Base for Wide Mouth or Mason Jars. Comes with one Borosilicate glass wide mouth 250 ml jar and small size blending assembly (E8710). Also available with Centrifugal Flow Blending Assembly, Order No. E8497. Fits Waring power units.	Yes	E8495
	Centrifugal Flow Blending Assembly with Blender Base. The stator, rotor configuration of the blending assembly forces the flow of liquids through the cutting blades causing the efficient cell and tissue homogenization via high speed mechanical disruption. May be used for emulsification of non-miscible liquids, resuspension of slurries and at lower speeds, general mixing with minimal aeration of sample.	Yes	E8497
	SPECIAL-PURPOSE CONTAINER FOR Waring® BLENDERS, 1-Liter, Stainless Steel With 2PC. Vinyl Lid, 500 mL Working Max., Min. 75 mL	Yes	E8505

Image	Description	Autoclavable	Catalog number
	Stainless Steel Container w/ Stainless Press Fit Cover. 1-Liter container with working maximum of 500 ml and minimum of 75 ml. Container has standard blending assembly (E8670). Fits Waring power units.	Yes	E8510
	1 Liter Stainless Steel Container w/ Screw Cover and Sample Plug. 1-Liter container with working maximum of 500 ml and minimum of 75 ml. The screw cover is sealed with neoprene o-rings on both the outside diameter and sample plug. Fits Waring power units.	Yes	E8520
	Stainless Steel, Micro Container. Working capacity of 3 ml min. to 30 ml max. Container and cutting assembly are stainless steel with Teflon gaskets for screw cover and threaded sampling plug. Base is cast aluminum providing a stable support and heat sink. Entire container can be pre-chilled to provide additional heat absorbing capacity. The unit is 6 3/4" H overall. The container measures 1 1/4" dia x 3 1/2" H. The unit can be disassembled for cleaning and sterilizing with the tools provided. Fits Waring power units.	Yes	E8575
	Semi-Micro Container, Stainless Steel with Press Fit Lid. Total capacity is 360 ml with a maximum working volume of 250 ml and a minimum of 25 ml. Measures 6 3/4" H x 1 1/8" dia at bottom, flaring to 1 15/16" on top. Complete with semi-micro blending assembly (E8730). Fits Waring power units.	Yes	E8580
	Semi-Micro Container, Stainless Steel with Screw Cover and neoprene cover gaskets. Same as the E8580 but with screw cover and sample plug. Fits Waring power units.	Yes	E8581
	Semi-Micro container assembly with Cooling Jacket and press fit lid. Like E8580 but surrounded by a stainless steel cooling jacket. The cooling jacket is 5 1/2" dia x 4" H. Tablatures for circulating liquid are 3/8" in diameter x 1 1/2" long. Ice or dry ice may be added to the surrounding fluid through holes in the jacket top. Complete with semi-micro blending assembly (E8730). Fits Waring power units.	Yes	E8590
	1-LITER BLENDING CONTAINER ADAPTER FOR 4-LITER POWER UNITS, Waring Model CB-6, Eberbach E8015/E8017/E8018	N/A	E8051

PRODUCT: | **E8530**

PURPOSE: | **MULTI-BLADE BLENDING CONTAINER**

1-Liter stainless steel multi-blade container. Working maximum of 750 ml and minimum of 75 ml. The screw cover and sample plug are sealed with neoprene o-rings. Useful in applications where the entire fluid column must be blended as when dealing with viscous liquids or semi-solids.



Inside view of E8530 container



E8530 Multi-Blade with Cap

PRODUCT SPECIFICATIONS...

BLENDING CAPACITY	<ul style="list-style-type: none"> • 75 ml Minimum Blending Capacity • 750 ml Maximum Blending Capacity
MATERIAL:	<ul style="list-style-type: none"> • 300 Series Stainless Steel
COMPATIBLE BLENDERS:	<ul style="list-style-type: none"> • All 1-liter Waring Blenders (4 Liter blenders with Adaptor E8051) • Eberbach Hazardous Location Blenders
SIZE AND WEIGHT:	<ul style="list-style-type: none"> • Height: 8.5 in • Width: 4.5 in • Weight: 3.8 lbs

DURABILITY • CRAFTSMANSHIP • QUALITY

1-800-422-2558 | WWW.EBERBACHLABTOOLS.COM

BLENDING ASSEMBLIES

	Assembly parts	Standard No. E8670	Small No. E8710	Semi-Micro No. E8730	Standard No. E8672	Small No. E8712	Semi-Micro No. E8732	
	Cap Nut	E8670.05 pkg of 6	E8670.05 pkg of 6	E8670.05 pkg of 6	E8672.06 Stainless	E8672.06 Stainless	E8672.06 Stainless	
	Stainless Blade	E8680	E8720	E8740	E8680	E8720	E8740	
	Bearing Cap	E8670.10	E8670.10	E8670.10	E8672.11 Stainless	E8672.11 Stainless	E8672.11 Stainless	
	Seal Washer	E8670.15 pkg. of 12	E8670.15 pkg. of 12	E8670.15 pkg. of 12	Teflon E8672.16 pkg. of 12	Teflon E8672.16 pkg. of 12	Teflon E8672.16 pkg. of 12	
	Bearing Holder	E8670.20	E8670.20	E8670.20	E8672.22 Stainless	E8672.22 Stainless	E8672.22 Stainless	
	Thrust Washer	E8670.25 pkg. of 12	E8670.25 pkg. of 12	E8670.25 pkg. of 12	E8670.25 pkg. of 12	E8670.25 pkg. of 12	E8670.25 pkg. of 12	
	Socket Head Drive Shaft	E8670.30	E8670.30	E8670.30	E8670.30	E8670.30	E8670.30	
	Nylon Washer	E8670.32 pkg. of 12	E8670.32 pkg. of 12	E8670.32 pkg. of 12	E8670.32 pkg. of 12	E8670.32 pkg. of 12	E8670.32 pkg. of 12	
	Stainless Washer	E8670.35 pkg. of 12	E8670.35 pkg. of 12	E8670.45 pkg. of 6	E8670.35 pkg. of 12	E8670.35 pkg. of 12	E8670.45 pkg. of 6	
	Gasket	Rubber E8750 pkg. of 12	Rubber E8750 pkg. of 12	Rubber E8760 pkg. of 12	Teflon E8752 pkg. of 5	Teflon E8752 pkg. of 5	Teflon E8762 pkg. of 5	
	Container Base Parts							
	Gasket*	Rubber E8750 pkg. of 12	Rubber E8750 pkg. of 12	Rubber E8750 pkg. of 12	Teflon E8752 pkg. of 5	Teflon E8752 pkg. of 5	Teflon E8762 pkg. of 5	
	Stainless Washer	E8670.35 pkg. of 12	E8670.35 pkg. of 12	E8670.35 pkg. of 12	E8670.35 pkg. of 12	E8670.35 pkg. of 12	E8670.35 pkg. of 12	
	Hex Nut	E8670.40 pkg. of 6	E8670.40 pkg. of 6	E8670.40 pkg. of 6	E8670.40 pkg. of 6	E8670.40 pkg. of 6	E8670.40 pkg. of 6	

*Number of washers/gaskets needed may vary in order to maintain 3/16" clearance between socket head drive shaft and bottom of container base

PARTS FOR BLENDING POWER UNITS

	Part	4-Liter	One-Speed	Two-Speed	Two-Speed w/ Timer
	Square Drive Stud*	n/a	E8400.55 (1/4-28) E8400.57 (12-24)	E8400.55 (1/4-28) E8400.57 (12-24)	E8400.55 (1/4-28) E8400.57 (12-24)
	Washer Drive Stud	n/a	E8400.60	E8400.60	E8400.60
	Slinger	n/a	E8400.65	E8400.65	E8400.65
	Rubber Coupling	n/a	E8400.70 (1/4-28) E8400.72 (12-24)	E8400.70 (1/4-28) E8400.72 (12-24)	E8400.70 (1/4-28) E8400.72 (12-24)
	Coupling Assembly (includes 4 parts listed above)	Complete E8000.75	E8400.75 (1/4-28) E8400.77 (12-24)	E8400.75 (1/4-28) E8400.77 (12-24)	E8400.75 (1/4-28) E8400.77 (12-24)

* Note thread size in parenthesis

** Parts are available for all Waring Blenders; contact Eberbach Customer Service

Eberbach Labtools Wrench Set Order No. E8770

- For removing and installing blending assemblies
- Consists of 4 wrenches:
 - (A) for cap nut to secure the blades;
 - (B) for large nut which secures assembly in container;
 - (C) for holding drive shaft when removing cap nuts;
 - (D) spanner wrench for securing bearing holder during assembly
 - (E) gap tool for aligning blending assembly with drive stud size gauge
- Not for use with 4-Liter blending assembly

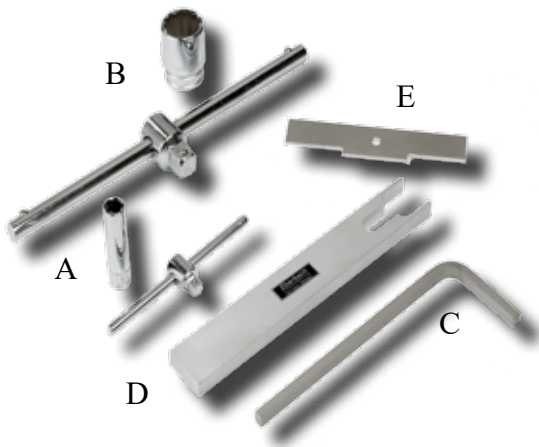

DURABILITY • CRAFTSMANSHIP • QUALITY

1-800-422-2558 | WWW.EBERBACHLABTOOLS.COM

Microscope Slide Storage

Eberbach's Microslide cabinets and Petrographic Microslide cabinets provide safe, short-term and long-term, storage of prepared slides which can easily be indexed for retrieval.

Sturdy aluminum micro slide trays, numbered in sets of 25, are removable and interchangeable between cabinet systems. Individual compartments for laying slides flat, maintain cover glasses in place, preserving your work year round. Nominal capacity can be doubled, as two micro slides can be stacked in each compartment. Unnumbered, replacement slide trays are sold separately (75x25mm slides tray: Order No. E2870) or (75x50mm slides tray: No. E2875).

Cabinets are available in (2) two styles, a Unit System and a Cabinet System. The flat sides and disappearing door of the Unit System provide for easy stacking and/or banking. The Cabinet System will initially handle a larger number of slides with drawer space at the bottom for a card index. Doors are supported by piano type hinges ensuring long operation and a close fit.









*Solid oak options are available







Rock-Solid Construction

- Seasoned hardwood cabinets are finished in attractive light oak
- Unit System has doors that slide into the cabinet to remain hidden while storing/retrieving slides
- Cabinet Systems include drawer space at bottom for a file index

STANDARD MICROSCOPE SLIDE CABINETS

Image	Slide Size (mm)	# Of Slides	Trays/Cabinet	Slides/Tray	Dimensions W x D x H	Catalog number
	75 x 25	500	25	20	8.5" x 13" x 11"	E2800
	75 x 50	250	25	10	8.5" x 13" x 11"	E2810
	75 x 25	1000	50	20	9.75" x 13.75" x 22"	E2820
	75 x 50	500	50	10	9.75" x 13.75" x 22"	E2825
	75 x 25	2000	100	20	17.25" x 13.75" x 22"	E2830
	75 x 50	1000	100	10	17.25" x 13.75" x 22"	E2835
	75 x 25	3000	150	20	22" x 13.75" x 24.75"	E2840
	75 x 50	1500	150	10	22" x 13.75" x 24.75"	E2845

PETROGRAPHIC MICROSCOPE SLIDE CABINETS

Image	Slide Size (mm)	# Of Slides	Trays/Cabinet	Slides/Tray	Dimensions	Catalog number
	75 x 25	500	25	20	8.5" x 13" x 11"	E4040
	75 x 25	1000	50	20	9.75" x 13.75" x 22"	E4080
	75 x 50	500	50	10	17.25" x 13.75" x 22"	E4100
	75 x 25	2000	100	20	22" x 13.75" x 24.75"	E4120

MICROSCOPE SLIDE TRAYS

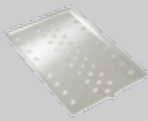
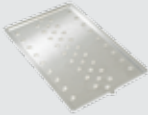
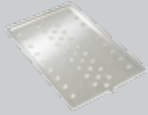
Image	Slide Size (mm)	Slides/Tray	Dimensions	Catalog number
	Standard 75 x 25	20	7.25" x .25 x 11.25"	E2870
	Double Wide 75 x 50	10	7.25" x .25 x 11.25"	E2875
	Petrographic 46 x 27	30	7.25" x .25 x 11.25"	E4140

PRODUCT: | **E2750**

PURPOSE: | **MICROSCOPE SLIDE WARMING TABLE**

The E2750 Microscope Slide Warming Table is used in embedding tissues with paraffin, this enables the technician to melt paraffin, preheat slides and cool them after the embedding process. The Warming Table is built from aluminum and steel and consists of a heated section, 11 3/4" L x 4" W and an ambient section 4" square. The footprint of the base is 17" L x 1 3/4" H. A 45 W heater is mounted beneath one end of the long section on a vertical post and is adjustable in height making possible variations in temperature from 30' to 90' Celsius

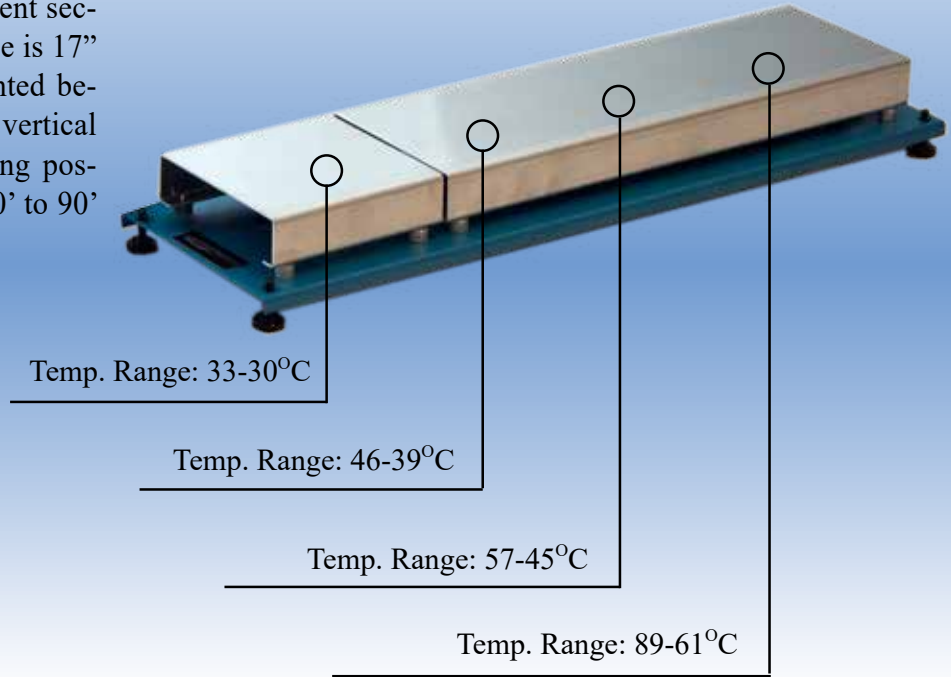

PRODUCT SPECIFICATIONS...

TEMPERATURE RANGE:	30 to 90 C
HEAT SECTIONS:	Heated Section: 11 3/4" L x 4" W Ambient Section: 4" Square
PRODUCT FOOTPRINT:	17" L x 5 1/2" W x 1 3/4" H
HEATER:	45 Watts
POWER REQUIREMENTS:	115V 50/60Hz Order E2750 230V 50/60Hz Order E2755

Apparatus Equipment



PRODUCT: | E1000
PURPOSE: | ELECTRO-ANALYZER

Eberbach's Electro-Analyzer E1000 apparatus is used for the determinations of lead, nickel, copper, zinc, antimony, cadmium and other metals by the electro-deposition process. Unit has a finished steel case (30" high) with stainless steel front surface and occupies a table space of 15" x 17". The front panel protects the apparatus from corrosive spillage and fumes. No electrically corrodible components are positioned where material may fall into the cell and alter results. The unit delivers up to 10 volts, 10 amperes DC at each of two positions for simultaneous determinations. Separate ammeters (0-10A) and center-zero voltmeters (10-0-10V) indicate amount and direction of current flow at each position. Polarity reversing switches change the polarity of the electrodes. Current to each position is supplied by individual power transistors controlled by potentiometers. In line fuses protect AC and DC circuits. Stirrers are driven at a constant speed of 620 rpm by a split-phase induction motor. Hollow spindles permit easy vertical adjustment of the glass stirring rods. Power to each stirrer and entire unit is controlled by individual switches with pilot lamps. Heavy-duty platinum electrodes (45 mesh) are recommended for this unit however, lighter weight electrodes may be used. Spring loaded electrode holders grip the electrodes without deforming the stem and may be moved horizontally for centering nested electrodes. For rotating anode techniques a stainless steel rotating anode holder may be substituted for glass stirring rod. This unit ships with 2 E1060 glass agitators.



PRODUCT SPECIFICATIONS...

DC OUTPUT CHARACTERISTICS:	<ul style="list-style-type: none"> • Two position DC output • 0-10V, 0-10A at each position • Polarity reversible
INTEGRAL STIRRER:	<ul style="list-style-type: none"> • 620 rpm fixed • Adaptable for use with rotating anode
POWER REQUIREMENTS:	115V, 50/60Hz or 230V, 50/60Hz 550Watts 3 wire UL listed power cord included
SIZE AND WEIGHT:	Height: 29.5 in (75cm), Width: 15.25 in (38.7 cm), Depth: 16.5 in (42cm), Weight: 125 lbs (56.7 kgs)
ACCESSORIES:	<ul style="list-style-type: none"> • Heater, Thermostatically Controlled, 115V 50/60Hz Order No. E1020 • Heater, Thermostatically Controlled, 230V 50/60Hz Order No. E1020.20 • Holder for Rotating Anode Order No. E1050 • Agitator Order No. E1060
PLATINUM ELECTRODES:	Stationary Type <ul style="list-style-type: none"> • Anode: Cylinder Diameter: 1" Cylinder. Height: 2 1/4" Overall Height: 5 1/2" Mesh: 45 Weight: 25 gm Order E1100 • Cathode: Cylinder Diameter: 2" Cylinder. Height: 2 1/4" Overall Height: 5 1/2" Mesh: 45 Weight: 39.5 gm Order E1120 Rotating Type <ul style="list-style-type: none"> • Anode: Cylinder Diameter: 1/2" Cylinder. Height: 2" Overall Height: 5" Mesh: 45 Weight: 14 gm Order E1140

DURABILITY • CRAFTSMANSHIP • QUALITY

PRODUCT: | E5160
PURPOSE: | CATHETOMETER

Eberbach Cathetometers are used for the easy and accurate measurement of vertical and horizontal distances or displacements, especially where close observation is difficult or dangerous. These units are indispensable where ordinary methods would introduce errors of parallax. Units measure either vertically or horizontally. The optical system consists of short-focus telescope with draw tube, eyepiece with cross hair rotatable through 360 degrees, and build-in image erecting system, making the unit convenient for reading thermometers, other scales, or printed matter. The telescope is 8” long while closed, and opens up to 10 1/2”. The draw tube can be clamped firmly to prevent shifting between readings while making focusing easy at any distance between 30 cm and infinity. Magnification of the telescope is varying from 20X at 30cm to 8X at infinity while the field is 13mm in diameter at 30 cm and 118 mm at 200 cm. The telescope is mounted on a custom clamp which is mounted on to a column slide, and travels the main column by way of a smoothly operating rack-and-pinion system. The telescope swings through a 90 degree plane about the axis of the main column while being supported by a V-cradle type support which can be adjusted laterally for a distance of 3/4” and fixed at any position about its vertical axis. The digital slide system has a resolution of 0.01 mm with an accuracy of +/- (0.02 + 0.00005 x L (mm)). It is powered by a silver oxide battery.



PRODUCT SPECIFICATIONS...

FOCUS RANGE:	30 cm to infinity
MAGNIFICATION:	Varies from 20X at 30 cm to 8X at infinity
FIELD OF VIEW:	3 mm in diameter at 30 cm and 118 mm at 200 cm
TELESCOPE SIZE:	8” Length closed, 10.5” Length Open
SETUP OPTIONS:	<ul style="list-style-type: none"> • Can be used vertically or horizontally • Extra clamps and telescopes can be added to monitor simultaneous measurements • Built in image erecting system
PURCHASE OPTIONS:	<p>Eberbach Labtools E5160 Cathetometer, Order No. E5160</p> <ul style="list-style-type: none"> • 60 cm cathetometer • Custom telescope clamp • Telescope • Use & care manual <p>Telescope, Order No. E5320</p> <p>Telescope Clamp, Order No. E5200</p>



Telescope, Order No. E5320

EBERBACH WARRANTY INFORMATION

**EBERBACH STANDS BEHIND ITS PRODUCT
QUALITY WITH AN INCLUDED:**

5 YEAR “BUMPER TO BUMPER” WARRANTY*

**THIS INCLUDES PARTS
AND LABOR AND THE COST OF SHIPPING.**

*DOES NOT INCLUDE CONSUMABLES OR WEAR PARTS

*RETURN SHIPPING DOES NOT APPLY TO INTERNATIONAL ORDERS

MIXING | MILLING | SHAKING | BLENDING

Shop our Products at
www.eberbachlabtools.com



MIXING | MILLING | SHAKING | BLENDING

WWW.EBERBACHLABTOOLS.COM | 1.800.422.2558