

## Lab Hose Cocks and Turrets

### BL-4000-01 Hose Cock

- CSA approved
- 3/8" NPT male inlet
- Serrated hose tip
- Snap-in color index; specify gas, air or vacuum
- Length 3-3/16" (81 mm); height 2-1/2" (63 mm)



Note: **should not** be used for water, steam or oxygen

BL-4000-01M Master Box (12)

### BL-4100-0 Laboratory Turret

- Two 3/8" NPT female outlets at 90°
- 3/8" NPT female inlet
- Black plastic mounting gasket included
- 2" (51 mm) diameter; height 2-9/16" (65 mm)
- 2" (51 mm) height to center of outlet



- BL-4100-01 3/8" NPT female bottom inlet; 3/8" NPT female side outlet (1)
- BL-4100-02 Two outlets at 180°
- BL-4100-03 Three outlets
- BL-4100-04 Four outlets
- BL-4100-05 Top outlet only

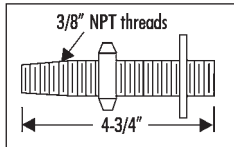

Note: BL-5500-10 supply nipple and locknut ordered separately

### BL-4102-0 Vandal Resistant Lab Turret

- 1/4" diameter stud to prevent rotation
- Black plastic mounting gasket included
- 2" (51 mm) diameter; height 3" (76 mm)
- 2-1/8" (54 mm) height to center of outlet
- 3/8" NPT female inlet
- Two 3/8" NPT female side outlets



- BL-4102-01 3/8" NPT female bottom inlet; 3/8" NPT female side outlet (1)
- BL-4102-02 Two outlets at 180°

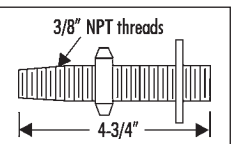

Note: BL-5500-10 supply nipple and locknut ordered separately

### BL-4010-01 Needle Valve

- 3/8" NPT male inlet
- Floating stainless steel needle point
- Serrated hose tip
- For use with oxygen, hydrogen or other special gases
- Length 3-3/16" (81 mm); height 2-15/16" (75 mm)
- 125 PSI maximum pressure

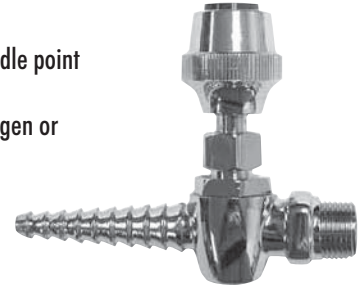

Note: **should not** be used for water or steam

### BL-4200-0 Turret with Two Hose Cocks

- 3/8" NPT female inlet
- Snap-in color coded index; specify gas, air or vacuum
- Diameter 2" (51 mm); height 3-9/16" (90 mm)
- Two hose cocks at 90°
- Not recommended for pressures in excess of 30 PSI



- BL-4200-01 Turret with hose cock
- BL-4200-02 Turret with two hose cocks at 180°
- BL-4200-04 turret with four hose cocks

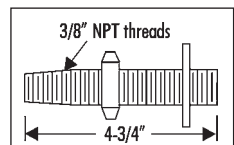

Note: BL-5500-10 supply nipple and locknut ordered separately

### BL-4203-0 Vandal Resistant Turret with Hose Cock

- 1/4" diameter stud to prevent rotation
- 3/8" NPT female bottom inlet
- Two 3/8" NPT hose cocks at 90°
- 2" (51 mm) diameter; 3-11/16" (94 mm) height
- 2-1/8" (54 mm) height to center of outlet
- Snap-in color coded index; specify gas, air or vacuum
- Not recommended for pressures in excess of 30 PSI



- BL-4203-01 3/8" IPS female side outlet (one)
- BL-4203-02 Turret with two hose cocks at 180°
- BL-4203-04 Turret with four hose cocks

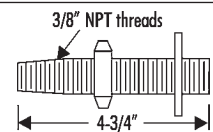

Note: BL-5500-10 supply nipple and locknut ordered separately

## Panel Flanges, Hose Cocks and Turrets

### BL-4210-01 Turret with Needle Valve

- 3/8" NPT female bottom inlet
- One 3/8" NPT hose cock
- 2" (51 mm) diameter; 4-3/8" (111 mm) height
- 2" (51 mm) height to center of outlet
- Valve has floating stainless steel needle point
- For use with oxygen, hydrogen or other special gases



BL-4210-0

**BL-4210-0** Turret with two needle hose cocks at 90° (shown above)

**BL-4210-02** Turret with two needle hose cocks at 180°

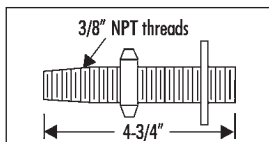

Note: BL-5500-10 supply nipple and locknut ordered separately

### BL-4250-02 Double Panel Flange with Two Hose Cocks

- 3/8" NPT female inlet
- Dual ground key hose cocks with serrated hose tips
- 3-7/8" (98 mm) from wall
- 1-13/16" (46 mm) flange diameter
- 6-1/8" (156 mm) width
- Snap-in color coded index; specify gas air or vacuum
- Not recommended for pressures in excess of 30 PSI

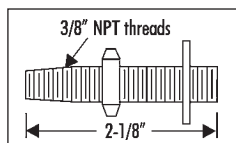
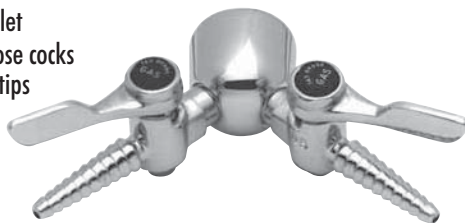

Note: BL-5500-07 panel supply nipple and locknut ordered separately

**Inset: BL-4250-05**  
Double panel flange with 3/8" NPT inlet and dual outlets

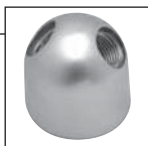

### BL-4250-08 Wye Fitting

- 3/8" NPT male inlet
- Two 3/8" NPT female outlets
- 70° angle between outlets



### BL-4250-01 Panel Flange with Hose Cock

- 3/8" NPT female inlet
- Ground key hose cock
- Serrated hose tip
- 4-1/2" (114 mm) length
- 2" (51 mm) flange diameter
- Snap-in color coded index; specify gas, air or vacuum
- Not recommended for pressures in excess of 30 PSI

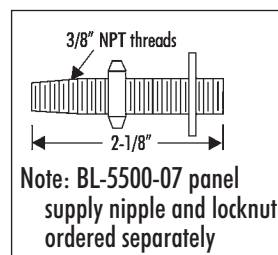
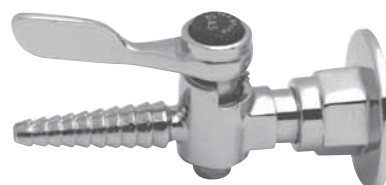

Note: BL-5500-07 panel supply nipple and locknut ordered separately

### BL-4250-07 Flanged Elbow

- 3/8" IPS female inlet and outlet
- 2" (51 mm) flange diameter
- 2-1/16" (52 mm) from flange surface to center of outlet
- Can be mounted vertically or horizontally



### BL-4260-01 Panel Flanges with Needle Valve

- 3/8" NPT female inlet
- Needle valve with serrated hose tip
- 4-1/2" (114 mm) length from wall to tip
- 2" (51 mm) diameter flange
- Snap-in color coded index; specify gas, air or vacuum



**Inset: BL-4250-03** Panel flange with 3/8" NPT female inlet and outlet  
**BL-4250-04** Same as BL-4250-03 except with 1/2" NPT female inlet and outlet  
**BL-4250-06** Same as BL-4250-03 except with 1/2" NPT female inlet, 3/8" NPT female outlet

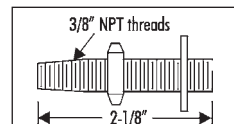

Note: BL-5500-07 panel supply nipple and locknut ordered separately

## Panel Flanges, Stops and Turrets

### BL-4300-0 Turret with Two Straight Stops

- Turret with two straight stops (BL-4500-1) at 90°
- 3/8" NPT female inlet
- Serrated hose tips
- 5-1/2" (140 mm) from center of inlet to end of tip
- 5-1/2" (140 mm) height
- 2" (51 mm) diameter turret
- Snap-in color coded index; specify gas, air or vacuum

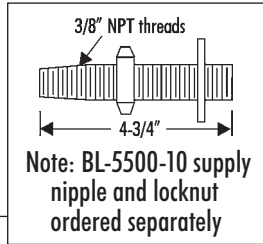

**BL-4300-01** Turret with one straight stop

**BL-4300-02** Turret with two straight stops at 180°

**BL-4300-04** Turret with four stops

### BL-4422-0 Turret with Two Water Outlets

- 2" (51 mm) diameter turret base
- Double water outlet with angle serrated hose tips at 90°
- Atmospheric vacuum breaker
- 3/8" NPT female inlet

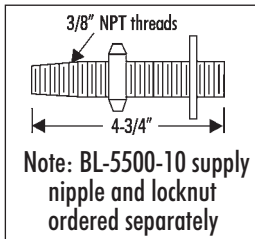

**BL-4422-01** Same as BL-4422-0 except with one water outlet

### BL-4501-01 Straight Stop

- Straight stop for special gases
- 3/8" NPT male inlet
- Internal floating stainless steel cone regulates gas flow as handle is turned
- Serrated hose tip



### BL-4350-01 Panel Flange with Straight Stop

- 3/8" NPT female inlet
- Serrated hose tip
- 5-5/8" (143 mm) length
- 2" (51 mm) diameter flange
- Snap-in color coded index; specify gas, air or vacuum
- Internal floating stainless steel cone regulates gas flow as handle is turned
- Forged brass four arm handle



**BL-4355-01** Same as BL-4350-01 except for water; specify hot or cold

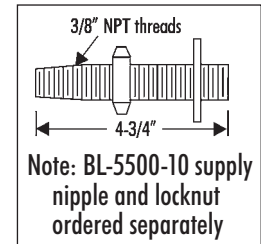

### BL-4500-01 Straight Stops

- 3/8" NPT male inlet
- 5" (127 mm) length
- Removable serrated hose tip
- Forged brass four-arm handle
- Snap-in color coded index; specify gas, air or vacuum
- Internal floating stainless steel cone regulates gas flow as handle is turned

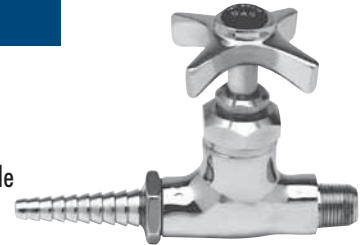

**BL-4500-02** Same as BL-4500-01 except with Eterna construction for water; specify hot or cold

**BL-4500-04** Same as BL-4500-03 except with angle serrated tip

### BL-4520-01 Angle Stop

- 3/8" NPT male inlet
- Serrated hose tip
- Floating stainless steel cone and removable seat
- Forged brass four-arm handle with colored index
- Snap-in color coded index; specify gas, air or vacuum
- 3-1/2" (89 mm) length from center
- 4-5/8" (117 mm) height



Note: 3/8" NPT female or 1/2" NPT male inlet available upon request

**BL-4520-02** Same as BL-4520-01 except Eterna construction for water; specify hot or cold

## Remote Control Valve Units

### BL-4700-01 Remote Control Straight Valve Unit

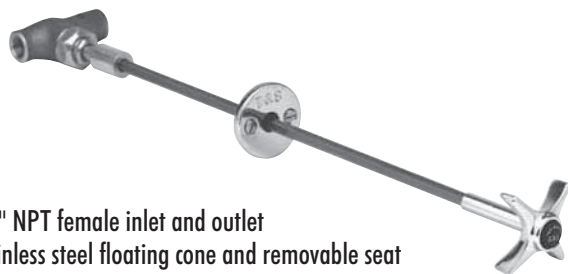

- 3/8" NPT female inlet and outlet
  - Stainless steel floating cone and removable seat
  - Snap-in color coded index; specify gas, air or vacuum
  - Specify distance from center of valve to face of panel – standard is 18" (457 mm)
  - Furnished with polished chrome guide for use on wood furniture
- Note: Valve can be furnished with 3/8" NPT male or 1/2" NPT male inlet when specified

**BL-4700-01MF** Same as BL-4700-01 except with guide bushing for metal furniture

**BL-4700-02** Same as BL-4700-01 except with Eterna construction for water; specify hot or cold

### BL-4720-01 Remote Control Angle Valve Unit

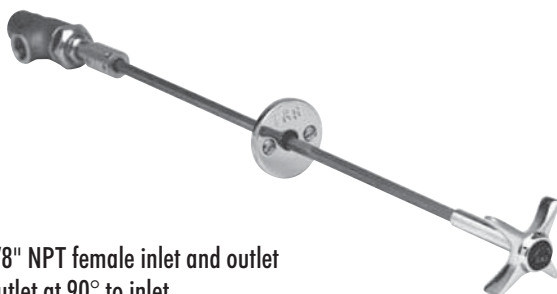

- 3/8" NPT female inlet and outlet
  - Outlet at 90° to inlet
  - Stainless steel floating cone and removable seat
  - Snap-in color coded index; specify gas, air or vacuum
  - Specify distance from center of valve to face of panel – standard is 18" (457 mm)
  - Furnished with polished chrome guide for use on wood furniture
- Note: Valve can be furnished with 3/8" NPT male or 1/2" NPT male inlet when specified

**BL-4720-01MF** Same as BL-4720-01 except with guide bushing for metal furniture

**BL-4720-02** Same as BL-4720-01 except with Eterna construction for water; specify hot or cold

**BL-4720-02MF** Same as BL-4720-02 except with guide bushing for metal furniture

**BL-4720-03** Same as BL-4720-01 except with stainless steel floating cone and seat for steam. With black heat resistant handle

### BL-4710-01 Remote Control Straight Valve Unit



- Universal joint at valve to correct for minor misalignment
- 3/8" NPT female inlet and outlet
- Stainless steel floating cone and removable seat
- Specify gas, air or vacuum
- Specify distance from center of valve to face of panel – standard is 18" (457 mm)
- Furnished with polished chrome guide for use on wood furniture

Note: Valve can be furnished with 3/8" NPT male or 1/2" NPT male inlet when specified

**BL-4710-02** Same as BL-4710-01 except with Eterna construction for water; specify hot or cold

**BL-4710-03** Same as BL-4710-01 except with stainless steel floating cone and seat for steam. With black heat resistant handle

### BL-4730-03 Remote Control Angle Valve Unit

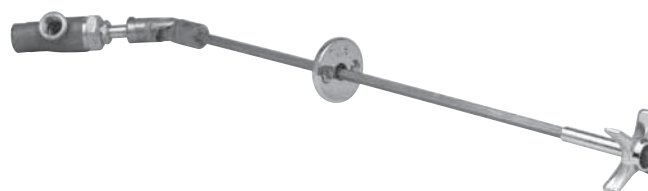

- Universal joint at valve to correct for minor misalignment
- 3/8" NPT female inlet and outlet
- Stainless steel floating cone and seat for steam
- Black heat-resistant handle (not shown)
- Snap-in color coded index; specify gas, air or vacuum
- Specify distance from center of valve to face of panel – standard is 18" (457 mm)
- Furnished with polished chrome guide for use on wood furniture

Note: Valve can be furnished with 3/8" NPT male or 1/2" NPT male inlet when specified

### Fume Hood Fittings

#### BL-4705-01 Front Mounted Fume Hood Valve

- 3/8" NPT female inlet and outlet
- For flat face hood
- Stainless steel cone and removable seat
- Forged brass four-arm handle with colored index
- Snap-in color coded index; specify gas, water or vacuum
- Working parts are removable from front eliminating entry into hood compartments



**BL-4705-02** Same as BL-4705-01 except with Eterna construction for water; specify hot or cold  
**BL-4705-03** Same as BL-4705-01 except with heat resistant handle for steam

#### BL-4750-05 Panel Flange with Straight Serrated Tip

- 3/8" NPT female inlet
- 2" (51 mm) diameter flange
- 3-5/8" (92 mm) length



**BL-4750-06** Same as BL-4750-05 except with angle serrated tip, 3-1/2" (89 mm) length

#### BL-4750-03 Turret with Rigid Gooseneck

- 3/8" NPT female inlet
- For use with remote valves
- Serrated hose tip
- Plastic mounting gasket included
- 2" (51 mm) diameter
- 11-1/2" (292 mm) height
- 5-1/2" (140 mm) spread gooseneck



**BL-4750-07** Same as BL-4750-03 except with wall mounted turret

### Front Guide Fittings for Remote Control Valve Units

#### BL-4740-03 Angle Guide Bushing

- Polished chrome plated
- For use on wood furniture
- Furnished with two screws
- 2" (51 mm) x 1-7/16" (37 mm)
- 45° angle standard – can be furnished at any angle from 30° to 60° in sufficient quantity
- Mounting holes on 1-9/16" (40 mm) centers



### Notes

---

---

---

---

---

---

---

---

---

---

---

---

---

---

---

---

---

---

---

---

---

---

---

---

---

---

---

---

---

---

---

## Support Rods and Accessories

### BL-9000-01 Upright Rod

- 3/4" (19 mm) diameter aluminum rod
- 39" (991 mm) long
- Tapered on one end to fit BL-9000-09 flush plate



### BL-9000-05 Aluminum Cross Bar

- 3/4" diameter aluminum rod
- 39" (991 mm) long

### BL-9000-09 Flush Plate

- 1-1/8" (29 mm) diameter shank
- Fits table tops from 3/4" (19 mm) to 1-1/2" (38 mm) thick
- Fits into recess in table to receive BL-9000-01 upright rods
- Satin chrome plated brass



### BL-9000-10 Clamp

- For 3/4" (19 mm) diameter aluminum rods
- Satin aluminum finish



### BL-9005-01 Crowned Top Flush Plate

- Convex top surface for use on tabletops without recess
- 1-1/8" (29 mm) diameter thread
- Fits table tops from 3/4" (19 mm) to 1-1/2" (38 mm) thick
- Designed to receive BL-9000-01 upright rods
- Satin chrome plated brass



## Double Ledge Faucets

### BL-5700-01 Double Ledge Faucet

- Single hole base with under counter spreader assembly
- 1/2" NPT male inlets
- 3/8" NPSM gooseneck, 5-1/2" (140 mm) spread
- 1-1/8" (25 mm) shank diameter
- 13-11/16" (347 mm) height
- Plastic mounting gasket included
- Serrated hose tip
- Tailpiece and nut furnished for optional 1/4" NPT connection



**BL-5700-02** Same as BL-5700-01 except with swivel gooseneck, 13-5/8" (346 mm) height

**BL-5700-03** Same as BL-5700-01 except with swivel gooseneck with swivel to rigid conversion washer

**BL-5700-04** Same as BL-5700-01 except with B-0199-02 aerator in place of serrated tip

### BL-5700-08 Double Ledge Faucet

- Rigid vacuum breaker gooseneck
- Single hole base with under counter spreader assembly
- 1/2" NPT male inlets
- 3/8" NPSM gooseneck with 5-7/16" (138 mm) spread
- 1-1/8" (29 mm) shank diameter
- 12-3/8" (314 mm) height
- Plastic mounting gasket included
- Serrated hose tip
- Tailpiece and nut furnished for optional 1/4" NPT connection



**BL-5700-08-VR** Same as BL-5700-08 except with vandal-resistant pins

**BL-5700-09** Same as BL-5700-08 except swivels at vacuum breaker

## Double Ledge Faucets

### BL-5704-01 Double Ledge Faucet

- 1/2" NPT male inlets
- Single hole base with under counter spreader assembly
- 3/8" NPSM gooseneck, 5-1/2" (140 mm) spread
- 1-1/8" (25 mm) shank diameter
- 13-11/16" (347 mm) height
- Plastic mounting gasket included
- Serrated hose tip
- Tailpiece and nut furnished for optional 1/4" NPT connection



**BL-5704-02** Same as BL-5704-01 except with swivel gooseneck

**BL-5704-03** Same as BL-5704-01 except with swivel gooseneck (5-7/8") spread and swivel to rigid conversion washer

**BL-5704-04** Same as BL-5704-01 except with B-0199-02 aerator in place of serrated tip (2.2 GPM)

**BL-5704-05** Same as BL-5704-04 except with quarter-turn eterna cartridges and 4" (102 mm) wrist action handles except with B-0199-02 aerator in place of serrated tip (2.2 GPM)

### BL-5704-08 Double Ledge Faucet

- Rigid vacuum breaker gooseneck
- 1/2" NPT male inlets
- Single hole base with under counter spreader assembly
- 3/8" NPSM gooseneck with 5-11/16" (144 mm) spread
- 1-1/8" (29 mm) shank diameter
- 12-3/8" (314 mm) height
- Plastic mounting gasket included
- Serrated hose tip
- Tailpiece and nut furnished for optional 1/4" NPT connection



**BL-5704-09** Same as BL-5704-08 except swivels at vacuum breaker

**BL-5704-08WH4** Same as BL-5704-08 except with 4" (102 mm) wrist action handles

## Single Ledge Lab Faucets

### BL-5705-01 Single Ledge Faucet

- Rigid gooseneck
- 1/2" NPSM shank
- 3/8" NPSM gooseneck with 5-5/8" (144 mm) spread
- 14-1/8" (359 mm) height
- Plastic mounting gasket included
- Removable serrated hose tip
- Specify hot or cold
- Fits ledge up to 1-1/2" (28 mm) thick
- Tailpiece and nut furnished for optional 1/4" NPT connection



**BL-5705-02** Same as BL-5705-01 except with swivel gooseneck, height 14-3/16" (360 mm)

**BL-5705-03** Same as BL-5705-01 except with swivel gooseneck with rigid to swivel conversion washer

**BL-5705-04** Same as BL-5705-01 except with B-0199-02 aerator in place of serrated tip

### BL-5705-08 Single Ledge Faucet

- Rigid vacuum breaker gooseneck
- 1/2" NPSM shank
- 3/8" NPSM gooseneck with 5-11/16" (144mm) spread
- 1-1/8" (29 mm) shank diameter
- 12-3/4" (324 mm) height
- Plastic mounting gasket included
- Serrated hose tip
- Specify hot or cold
- Fits ledge up to 1-1/2" (38 mm) thick
- Tailpiece and nut furnished for optional 1/4" NPT connection



**BL-5705-09** Same as BL-5705-08 except with swivel at vacuum breaker

**BL-5705-08-VR** Same as BL-5705-08 except with vandal-resistant anti-rotation screws in base, vandal-resistant handle and vandal-resistant loctited joints

## Lab Faucets

### BL-5710-01 Single Sink Faucet

- 1/2" NPT female inlet
- 3/8" NPSM rigid gooseneck
- 11" (279 mm) height from center of inlet to top of gooseneck
- 5-5/8" (143 mm) gooseneck spread
- 8-1/2" (210 mm) distance from wall to outlet
- Specify hot or cold water
- Serrated hose tip



**BL-5710-03** Same as BL-5710-01 except with swivel gooseneck

**BL-5710-07** Same as BL-5710-01 except with rigid vacuum breaker nozzle, 10-1/16" (256 mm) height from center of inlet to top of vacuum breaker

**BL-5710-09** Same as BL-5710-01 except with swivel vacuum breaker nozzle

**BL-5860-01TL** Same as BL-5710-01 except interior tin-lined for distilled water, with four arm handle

### BL-5715-08 Ledge Mixing Faucet

- Rigid vacuum breaker nozzle
- 1/2" NPT female inlets on 8" (203 mm) centers
- 3/8" NPSM rigid gooseneck
- 11-15/16" (303 mm) height from deck to top of vacuum breaker
- 5-7/16" (138 mm) nozzle spread
- Serrated hose tip



**BL-5715-01** Same as BL-5715-08 except with standard rigid gooseneck (inset, above)

**BL-5715-02** Same as BL-5715-01 except with standard swivel gooseneck

**BL-5715-09** Same as BL-5715-08 except with swivel vacuum breaker nozzle

### BL-5725-08 Sink Mixing Faucet

- Rigid vacuum breaker nozzle
- 1/2" NPT female inlets on 8" (203 mm) centers, wall mount
- 3/8" NPSM gooseneck
- 9-1/2" (241 mm) height from center of inlet to top of gooseneck
- 5-7/16" (138 mm) gooseneck spread
- Serrated hose tip



**Inset: BL-5725-01** Same as BL-5725-08 except with standard rigid gooseneck

**BL-5725-02** Same as BL-5725-01 except with standard swivel gooseneck

**BL-5725-09** Same as BL-5725-08 except with swivel vacuum breaker gooseneck

### BL-5707-01 Single Science Table Faucet

- Vandal resistant single science table faucet
- 1/2" NPSM shank
- 2" (51 mm) diameter on base
- Two brass balls lock into table top indents to prevent vandalizing (drilling template included)
- 13-3/16" (335 mm) height
- 6-1/2" (166 mm) spread nozzle
- 1/2" NPT heavy duty riser pipe
- Serrated hose tip
- Tailpiece and nut furnished for optional 1/4" NPT connection



**BL-5707-04** Same as BL-5707-01 except handle is 180° to nozzle



Lab Faucets

**BL-5707-03  
Combination Science Table Faucet**

- Vandal resistant combination science table faucet
- 1/2" NPSM shank
- 2" (51 mm) diameter on bases
- 12-3/4" (324 mm) height
- Two brass balls lock into table top indents to prevent vandalizing (drilling template included)
- 5-7/16" (138 mm) spread nozzle
- 1/2" NPT heavy duty riser pipe
- Serrated hose tip
- Plastic mounting gasket included
- Specify distance between centers of faucets – standard is 6"
- One hot index, one cold index
- Tailpiece and nut furnished for optional 1/4" NPT connection



**BL-5709-01  
Single Ledge Faucet**

- 1/2" NPT shank
- 3/8" NPSM gooseneck with 5-5/8" (144 mm) spread
- 14-1/8" (359 mm) height
- Specify hot or cold water
- Serrated hose tip
- Plastic mounting gasket included
- Tailpiece and nut furnished for optional 1/4" NPT connection



**BL-5709-02** Same as BL-5709-01 except with swivel gooseneck, height 14-3/16" (360 mm)  
**BL-5709-04** Same as BL-5709-01 except with B-0199-02 aerator in place of serrated tip

**BL-5709-08  
Single Ledge Faucet**

- Rigid vacuum breaker nozzle
- 1/2" NPSM shank
- 3/8" NPSM gooseneck with 5-7/16" (138 mm) spread
- 12-11/16" (322 mm) height
- Serrated hose tip
- Plastic mounting gasket included
- Specify hot or cold water
- Tailpiece and nut furnished for optional 1/4" NPT connection



**BL-5709-09** Same as BL-5709-08 except with swivels at vacuum breaker  
**BL-5709-05** Same as BL-5709-09 except with swivel nozzle with swivel to rigid conversion washer and 4" (102 mm) wrist action handle  
**BL-5709-08WH4** Same as BL-5709-08 except with 4" (102 mm) wrist action handle

**BL-5735-01  
Wall Mounted Mixing Faucet**

- 1/2" NPT female inlets
  - Rigid gooseneck with 5-5/8" (143 mm) spread
  - Four arm handles
  - Serrated hose tip
- Note: 3/4" female inlets and swing nozzle available as modifications

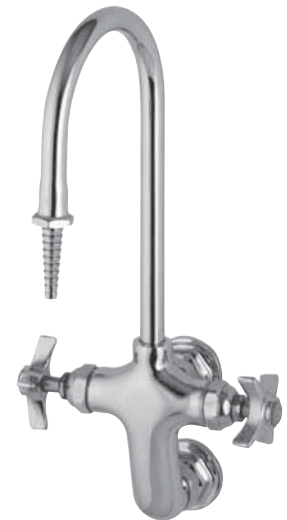

**BL-5735-09** Same as BL-5735-01 except with swivel vacuum breaker gooseneck nozzle  
**BL-5735-02** Same as BL-5735-01 except with swivel gooseneck

Lab Faucets

**BL-5740-01**  
Sink Mixing Faucet

- 1/2" NPT female inlets adjustable from 2-1/4" (57 mm) to 8-1/4" (210 mm) centers
- 3/8" NPSM rigid gooseneck
- 10-1/4" (260 mm) height from center of faucet to top of gooseneck
- 8-1/2" (216 mm) from wall to outlet of gooseneck
- 5-5/8" (144 mm) gooseneck spread
- Serrated hose tip



**BL-5740-02** Same as BL-5740-01 except with swivel gooseneck  
**BL-5740-08** Same as BL-5740-01 except with rigid vacuum breaker nozzle

**BL-5755-01**  
Single Temperature Lab Faucet

- 1/2" NPSM male shank
- Fits ledges up to 1-1/2" (38 mm) thick
- 9" (229 mm) swing nozzle with stream regulator outlet
- Four arm handle
- Tailpiece and nut furnished for optional 1/4" NPT connection



**BL-5750-01**  
Sink Mixing Faucet

- 1/2" NPT male inlet
- 3/8" NPSM gooseneck
- Removable serrated hose tip
- Specify hot or cold water
- Tailpiece and nut furnished for optional 1/4" NPT connection



**BL-5775-08**  
Sink Mixing Faucet

- 1/2" NPT female inlets on 8" (203 mm) centers
- 8-5/8" (219 mm) vacuum breaker swing nozzle
- Serrated hose tip



**BL-5775-01** Same as BL-5775-08 except with standard swing nozzle, no vacuum breaker

**BL-5850-01**  
Single Self-Closing Ledge Faucet

- 1/2" NPT female inlet
- 3/8" NPSM rigid gooseneck
- Fits ledges up to 1-1/2" thick
- Serrated hose tip
- Specify hot or cold water
- Tailpiece and nut furnished for optional 1/4" NPT connection
- 14-1/8" (359 mm) height
- 5-5/8" (181 mm) spread
- Fast self closing four arm handle

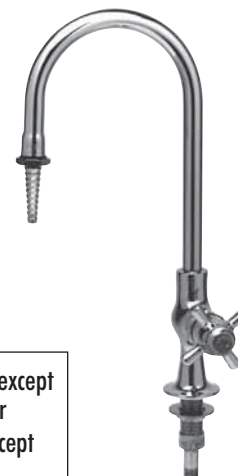

**BL-5850-01TL** Same as BL-5850-01 except interior is tin-lined for distilled water  
**BL-5850-02** Same as BL-5850-01 except with swivel gooseneck

**BL-5800-02**  
Single Supply Lab Faucet

- Serrated hose tip
- Four arm handle
- 1/2" NPT female inlet
- 4" (102 mm) length



Lab Faucets

**BL-6000-02**  
Combination Gas and Water Faucet

- Combination unit with gooseneck and two hose cocks
- 3/8" NPT male inlets for water and gas
- Serrated hose tip
- Specify gas, air or vacuum to snap-in color coded index
- 10-1/2" (267 mm) height
- 6" (152 mm) spread gooseneck
- Four arm handle
- Furnished with two (2) supply nipples, special lock washer, lock nuts and mounting gasket



**BL-6000-03** Same as BL-6000-02 except 15-1/4" (387 mm) height and 8" (203 mm) spread gooseneck

**BL-6005-02**  
Combination Gas and Water Faucet

- Combination unit with rigid vacuum breaker nozzle and two hose cocks
- 3/8" NPT male inlets for water and gas
- Serrated hose tip
- Specify gas, air or vacuum to snap-in color coded index
- 11-1/2" (292 mm) height
- 6" (152 mm) spread gooseneck
- Four arm handle
- Furnished with two (2) supply nipples, special lock washer, lock nuts and mounting gasket



**BL-6005-03** Same as BL-6005-02 except with 8" gooseneck spread

Lab Faucets and Miscellaneous Fixtures

**BL-6050-01**  
Multi-Water Fixture

- 1/2" NPT female inlet
- 3/8" NPSM gooseneck
- 18-3/8" (466 mm) overall height
- 5-5/8" (143 mm) spread rigid gooseneck
- Serrated hose tip
- One bottom valve
- Four arm chrome plated brass handles with colored index buttons

Note: BL-5500-12 supply nipple and lock nut sold separately



**BL-6050-02** Same as BL-6050-01 except with two bottom valves at 180°

**BL-9515-01**  
PVC Single Ledge Faucet Self-Closing

- PVC faucet with rigid gooseneck
- Dual lever control for manual or self-closing operation
- 1-1/4" (32 mm) dia. shank and locknut
- Serrated hose tip
- 3/8" NPT female inlet
- All PVC for use with distilled water
- 12-1/4" (311 mm) height, 6-1/4" (159 mm) spread



**BL-9515-02** Same as BL-9515-01 except no shank and lock nut, with 1/2" NPT female inlet  
**BL-9515-03** Same as BL-9515-01 except self-closing only

**BL-9505-01**  
PVC Single Ledge Faucet  
Compression Type

- PVC faucet with rigid gooseneck
- 1-1/4" (32 mm) diameter threaded shank and locknut
- Serrated hose tip
- 3/8" NPT female inlet
- All PVC for use with distilled water
- 12-1/4" (311 mm) height, 6-1/4" (159 mm) spread



**BL-9505-02** Same as BL-9505-01 except no shank and lock nut, with 1/2" NPT female inlet

**BL-5000-01**  
Double Pedal Valve

- Floor-mounted double pedal valve
- Self-closing valve with two pedals
- 1/2" NPT female inlets and outlet
- 2-1/2" (64 mm) center to center of inlets
- 1" (25 mm) from floor to center of inlets



**BL-5000-02**  
Single Pedal Valve

- Floor-mounted single pedal valve
- Self closing valve with one pedal
- 1/2" NPT female inlet and outlet
- 1" (25 mm) from floor to center of inlet



Lab Accessories

**BL-5500-0**  
Filter Pump (Aspirator)

- 3/8" NPT male inlet
- Includes check valve
- 2-15/16" (75 mm) overall length
- Creates suction by water flow



**BL-5500-07**  
Supply Nipple Unit

- Supply nipple and lock nut
- 3/8" NPT threads
- 2-1/8" (54 mm) long
- Used with panel flanges

**BL-5500-09** Same as BL-5500-07 except with 1/2" NPT threads, 2" (51 mm) long for use on panel mount faucets

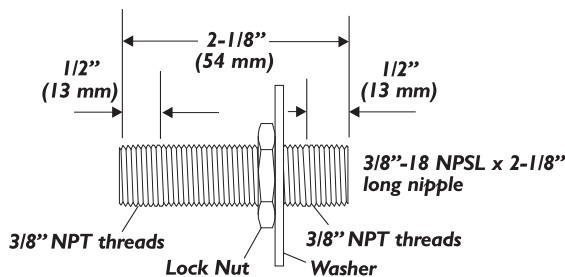

**BL-5500-03**  
6" Wrist Action Handle

- 6" (152 mm) long
- Can be used in place of lever handles originally furnished
- Chrome plated brass
- Includes color coded index button



**BL-5500-10**  
Supply Nipple Unit

- Supply nipple, lock nut and washer
- 3/8" NPT threads
- 4-3/4" (121 mm) long
- For use with BL-4100 turret series

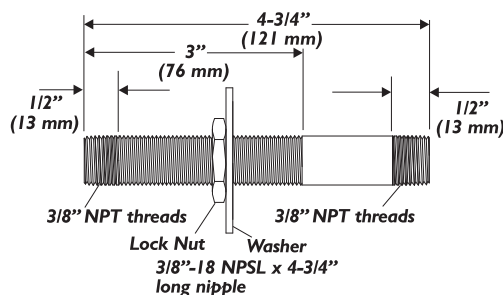

**BL-5500-08** Same as BL-5500-10 except with 1/2" NPT threads, 3-3/8" (86 mm) long; for use on ledge mount faucets

**BL-5505-07**  
Four Arm Handle

- Black polypropylene
- Color coded snap-in index button and screw



**BL-5545-01**  
Volume Control Unit

- Volume control fitting with adjustable volume control knob
- 3/8" NPT inlet and outlet

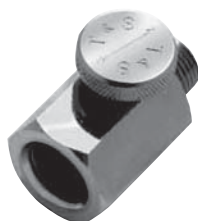

**BL-5550-01**  
Non-Splash Aerator

- Aerator with 3/8" NPSM male adapter
- Fits lab goosenecks



**BL-5550-01F** Same as BL-5550-01 except with flow control

Lab Accessories

**BL-5550-04**  
Straight Serrated Hose Tip

- 3/8" (9 mm) NPT male inlet
- Serrated hose tip
- 2-5/8" (67 mm) long
- Fits lab goosenecks and nozzles

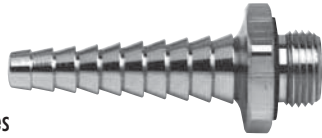

**BL-5550-05** Same as BL-5550-04 except with angle tip

**BL-5550-10**  
Vacuum Breaker

- Garden hose vacuum breaker prevents back siphonage
- 3/4" female garden hose inlet and male outlet
- Used to attach garden hose to unprotected hose bibb outlets



**BL-5550-23**  
Rigid to Swivel Adapter

- Converts 3/8" NPT rigid outlet to swivel
- Accepts T&S goosenecks and swing nozzles
- Use two washers (part no. 000986-45) to make nozzle or gooseneck rigid
- 1-5/16" (33 mm) height



**BL-5550-09**  
Vacuum Breaker

- Anti-siphon vacuum breaker prevents back siphonage
- 3/8" NPT male inlet and female outlet
- Used on outlets of goosenecks
- Use BL-5550-04 on tip on outlet



**BL-5550-12**  
Vandal Resistant Aerator

- 3/8" NPSM male inlet
- Use special wrench to attach (included)
- 3/4" total length
- Fits lab goosenecks and nozzles



**BL-5550-24**  
Swivel to Rigid Adapter

- Converts swivel outlet to 3/8" NPT female for rigid connection
- Accepts T&S rigid goosenecks and nozzles
- 1" (25 mm) height



**BL-5550-30**  
Restricted Swing Adapter

- Fits faucets with 3/8" NPT female outlet
- Restricts the swivel action for 100°
- Requires special nozzle or gooseneck fitted with restrictor pins



Notes

## Lab Accessories

### BL-5560-01 Rigid Gooseneck with Vacuum Breaker

- 3/8" NPT male inlet
- Serrated hose tip
- 8-7/8" (225 mm) total height
- 5-7/16" (138 mm) spread



**BL-5560-02** Same as BL-5560-01 except with swivel connection at vacuum breaker

### BL-5707-05 Spanner Screwdriver

- 8-7/16" (214 mm) spanner screwdriver

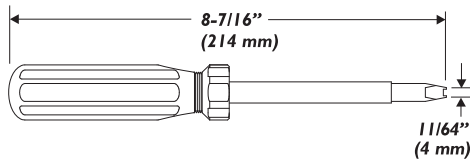

### BL-5561-02 Lab Nozzle

- 9" (229 mm) lab nozzle
- Stream regulator outlet
- Fits swivel faucets



**BL-5561-03** same as BL-5561-02 except 12" (305 mm) long

### BL-5707-10 Vandal Resistant Brace

- 6" (152 mm) vandal resistant brace
- For use on lab equipment



## Loose Key Stops

### B-0415 Straight Loose Key Stop

- 3/8" NPT female inlet and outlet



**B-0416** Same as B-0415 except with 1/2" NPT female inlet and outlet

### B-0418 Angle Loose Key Stop

- 1/2" NPT female inlet and outlet



### B-1311 Angle Key Stop

- 3/8" NPT female inlet
- Outlet with compression nut and sleeve to fit 1/2" (13 mm) O.D. copper tubing



### B-1305 Angle Loose Key Stop

- Flexible supply assembly with loose key angle stop
- 1/2" NPT female inlet
- 1/2" O.D. x 12" (305 mm) long flexible copper tube
- 2-1/2" (64 mm) diameter wall flange

**B-1305-01** Same as B-1305 except with 3/8" O.D. flexible copper tube

**B-1306** Same as B-1305 except with 3/8" NPT female inlet

**B-1306-01** Same as B-1306 except with 3/8" O.D. flexible copper tube



### B-1336 Angle Key Stop

- 3/8" NPT female inlet
- 3/8" NPT female outlet
- Loose key handle
- Vandal resistant (loose key stop)



**Loose Key Stops**

**B-1340  
Angle Stop**

- Angle stop with four arm handle (174F)
- 1/2" NPT female inlet
- Eterna spindle assembly (084A)
- Outlet with compression nut and sleeve to fit 1/2" (13 mm) O.D. copper tubing



**B-1341** Same as B-1340 except with 3/8" NPT female inlet

**B-1344  
Angle Stop**

- Angle stop with four arm handle (174F)
- Eterna spindle assembly (084A)
- 1/2" NPT female outlet



**B-1345** Same as B-1344 except with 3/8" NPT female inlet

**B-1350  
Angle Loose Key Stop**

- 1/2" NPT female inlet
- 1/2" NPT male outlet
- 2" (51 mm) diameter flange



**B-1351** Same as B-1350 except with 3/8" NPT female union coupled outlet

**B-1342  
Angle Key Stop**

- 1/2" NPT female inlet
- Eterna spindle assembly (123A)
- Outlet with compression nut and sleeve to fit 1/2" (13 mm) O.D. copper tubing

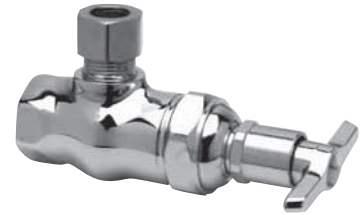

**B-1343** Same as B-0417 except with 3/8" NPT female inlet

**B-1346  
Angle Key Stop**

- 1/2" NPT female inlet
- Eterna spindle assembly (124A)
- 3/8" NPT female outlet
- Loose key handle



**B-1355  
Angle Loose Key Stop**

- 3/8" NPT female union coupling inlet
- 3/8" NPT Female outlet
- 2" (51 mm) diameter wall flange



**D  
65**

**Parts Kits For Plumbing**

**B-0230-K  
Parts Kit**

- Parts included:  
1/2" NPT Supply nipple, lock nut and washer  
1/2" NPT Male and female short EL

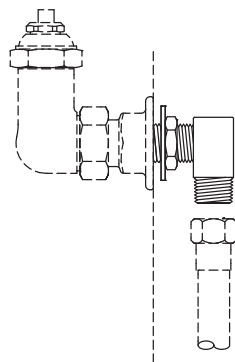

**B-1100-K  
Parts Kit**

- Parts included:  
1/2" NPT Male and female short EL

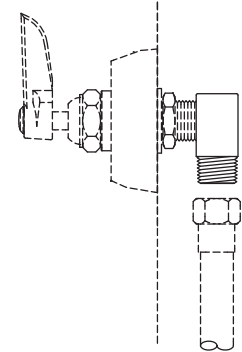

Parts Kits For Plumbing

**B-6K**  
Eterna Spindle Parts Kit

- Parts included:
- 1 000788-20 Right hand Eterna insert
- 1 000789-20 Left hand Eterna insert
- 1 000811-25 Right hand spindle insert
- 1 000812-25 Left hand spindle insert
- 4 000933-45 Seat washer screws
- 10 001022-45 Gaskets
- 12 002601-45 Gaskets
- 22 001092-45 Seat washers



**B-9K**  
Lever Handle Kit

- Parts included:
- 2 001638-45 Lever handle – blank
- 1 001661-45 Index button, red – hot
- 1 001660-45 Index button, blue – cold
- 2 000922-45 Lever handle screw



**B-11K**  
Eterna Cartridge Spindle Kit

- Parts included:
- 1 000811-25 Right hand spindle insert
- 1 000812-25 Left hand spindle insert
- 2 000933-45 Seat washer screw
- 2 009841-45 Seat washer



**B-15K**  
EasyInstall Concealed Widespread Faucet Parts Kit

- Parts included:
- 12 000922-45 Lever handle screw
- 32 000933-45 Screw
- 50 001098-45 Eterna spindle packing seal
- 6 009002-25 Packing nut/lock nut
- 25 002601-45 Gasket
- 25 001074-45 'O'-Ring
- 32 001136-45 Teflon seat washer
- 25 001022-45 Bottom gasket
- 6 000789-20 Left hand removable insert assembly
- 6 000812-25CWS Left hand spindle assembly
- 12 000788-20 Right hand removable insert assembly
- 12 000811-25CWS Right hand spindle assembly

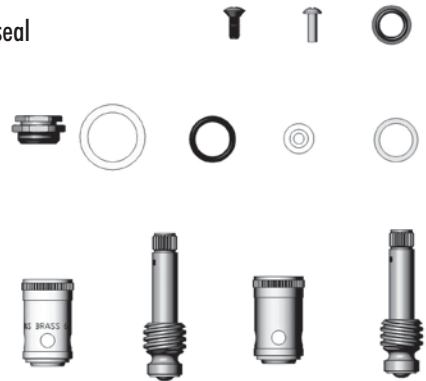

**B-13K**  
Spring Check Spindle Kit

- Parts included:
- 1 001907-25 Right hand spindle insert
- 1 001908-25 Left hand spindle insert
- 2 003164-45 Seat washer – spring check
- 2 001479-45 Spring check spring



**B-2730-DRK**  
Diverter Kit for B-2730

- Parts included:
- 1 Diverter valve stem
- 1 Diverter valve seal
- 2 Diverter valve 'O'-Rings
- 1 Diverter valve body
- 1 Diverter valve stem seal





**Parts Kits For Plumbing**

**B-18K  
Four Arm Handle Kit-Lab**

- Parts included:
- 2 000059-40 Four arm handle
- 2 000925-45 Handle screw
- 1 001191-45 Index button, green – cold
- 1 001194-45 Index button, red – hot



**B-WH4 and B-WH6  
Wrist Action Handles**

- Order:
- B-WH4-H 4" (102 mm) handle, hot index (red) and screw
- B-WH4-C 4" (102 mm) handle, cold index (blue) and screw
- B-WH6-H 6" (152 mm) handle, hot index (red) and screw
- B-WH6-C 6" (152 mm) handle, cold index (blue) and screw
- B-WH4 4" Handle only
- B-WH6 6" Handle only



**B-19K  
Four Arm Handle Kit-Service Sinks**

- Parts included:
- 2 002521-45 Four arm handle
- 2 000922-45 Handle screw
- 1 001660-45 Index button, blue – cold
- 1 001661-45 Index button, red – hot



**B-0466  
Wall Mount Faucet Adapter  
For T&S Faucet To Chicago/  
Zurn Inlets**

- Parts included:
- (2) Faucet adapters, includes (1) santoprene seal and (1) nitrile or EPDM seal per assembly
- 1-3/8" (35 mm) swivel hex nut with internal threads to fit T&S body
- Threads fit Chicago and Zurn inlet flanges



**B-0467  
Wall Mount Faucet Adapter  
For T&S Faucet To Fisher Inlets**

- Parts included:
- (2) Faucet adapters, includes (2) santoprene seals per assembly (one each end)
- 1-3/8" (35 mm) swivel hex nut with internal threads to fit T&S body
- Threads fit Fisher inlet flanges



**B-50P  
Foot Pedal Valve Parts Kit**

- Parts included:
- 4 009306-20 Valve stem
- 4 003690-45 Spring
- 4 000974-45 Bonnet washer
- 4 001040-45 Bonnet washer
- 4 001100-45 Packing stem
- 4 012915-45 B-0107 Seat washer (new style)
- 1 012665-45 Silicon grease tube



## Nozzles, Goosenecks and Spouts

### Swing Nozzles

- Nozzle tip has male threads with a stream regulator

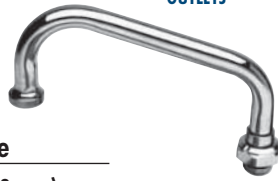

SERIES 1  
OUTLETS

Model No.	Standard Sizes Length	Standard Sizes Clearance
059X	6" (152 mm)	2-5/16" (59 mm)
060X	8" (203 mm)	2-15/16" (74 mm)
061X	10" (254 mm)	3-5/8" (92 mm)
062X	12" (305 mm)	3-3/4" (95 mm)
063X	14" (356 mm)	5" (127 mm)
064X	16" (406 mm)	5-13/16" (147 mm)
065X	18" (457 mm)	6-3/8" (162 mm)

059XM	Master Box (12)	064XM	Master Box (12)
060XM	Master Box (12)	065XM	Master Box (12)
061XM	Master Box (12)	060XP	Plain end outlet
062XM	Master Box (12)	062XP	Plain end outlet
063XM	Master Box (12)		

Note: Use Series 1 outlets on these swing nozzles

### Swivel Gooseneck

- Nozzle tip has male threads with a stream regulator



SERIES 1  
OUTLETS

SERIES 2  
OUTLETS

Model No.	Standard Sizes Spread	Standard Sizes Height	Standard Sizes Clearance
131X	2-13/16" (71 mm)	4-3/4" (120 mm)	2-9/16" (65 mm)
132X	2-3/4" (70 mm)	9-1/16" (230 mm)	5-9/16" (142 mm)
133X	5-11/16" (145 mm)	10-3/8" (264 mm)	6-3/8" (162 mm)
134X	7-3/4" (192 mm)	11-7/16" (290 mm)	5-1/2" (139 mm)
135X	8-3/4" (223 mm)	12-1/16" (306 mm)	5-9/16" (141 mm)
136X	12-1/4" (310 mm)	14-11/16" (373 mm)	5-3/8" (137 mm)

#### Swivel Gooseneck/Stream Regulator:

131X-ADA	ADA gooseneck
131XM	Master Box (6)
132XM	Master Box (6)
133XM	Master Box (6)
135XM	Master Box (6)

#### Swivel Gooseneck/Plain End:

132XP	Same as 132X except with plain end
133XP	Same as 133X except with plain end
134XP	Same as 134X except with plain end

Note: Use Series 2 outlets on these goosenecks except for 131X and 133X, which use Series 1 outlets

### Double-Joint Nozzles

- Nozzle tip has male threads with a stream regulator



SERIES 1  
OUTLETS

Model No.	Standard Sizes Back	Standard Sizes Front	Standard Sizes Total
066X	6" (152 mm)	6" (152 mm)	12" (305 mm)
067X	9" (229 mm)	6" (152 mm)	15" (381 mm)
068X	12" (505 mm)	6" (152 mm)	18" (457 mm)
069X	12" (305 mm)	12" (305 mm)	24" (610 mm)

#### Double-Joint Nozzle Sections

151X	6" (152 mm) back section
152X	9" (229 mm) back section
153X	6" (152 mm) front section

Note: Use Series 1 outlets on these nozzles

### Rigid Gooseneck

- Nozzle tip has 3/8" NPSM outlet with a stream regulator



SERIES 2  
OUTLETS

Model No.	Standard Sizes Spread	Standard Sizes Height	Standard Sizes Clearance
119X	2-3/4" (70 mm)	8-3/4" (222 mm)	5-1/4" (133 mm)
120X	5-1/2" (140 mm)	10-1/4" (261 mm)	5-5/16" (135 mm)
122X	5-1/2" (140 mm)	11-1/2" (292 mm)	6-7/16" (164 mm)
123X	5-1/2" (140 mm)	12-1/2" (318 mm)	7-1/2" (190 mm)
124X	5-1/2" (140 mm)	13-1/2" (343 mm)	8-9/16" (217 mm)
125X	5-1/2" (140 mm)	14-1/2" (368 mm)	9-9/16" (243 mm)
126X	5-1/2" (140 mm)	15-1/2" (394 mm)	10-1/2" (267 mm)
127X	7-5/8" (194 mm)	10-1/2" (267 mm)	4-1/2" (114 mm)
128X	7-5/8" (194 mm)	13-1/2" (343 mm)	7-9/16" (192 mm)
129X	8-5/8" (219 mm)	11-3/4" (298 mm)	5-1/2" (140 mm)
130X	12-3/16" (310 mm)	13-3/8" (340 mm)	4-9/16" (116 mm)
165X	4-1/16" (103 mm)	8-1/4" (210 mm)	4-13/16" (122 mm)

#### Rigid Gooseneck/Stream Regulator:

120XM	Master Box (6)
-------	----------------

#### Rigid Gooseneck/Plain End:

120XP	Same as 120X except with plain end
122XP	Same as 122X except with plain end
129XP	Same as 129X except with plain end

Note: Use Series 2 outlets on these goosenecks

Nozzles, Goosenecks and Spouts

Soap Dish Nozzle

- Nozzle has 3/8" NPSM female outlet with stream regulator
- A swing nozzle with soap dish can be supplied on T&S faucets instead of the standard nozzle



Model

No.	Length
160X	6" (152 mm)
161X	8" (203 mm)
162X	12" (305 mm)
163X	18" (457 mm)

Note: Use Series 2 outlets on these nozzles

Rigid Vacuum Breaker Gooseneck

- Rigid polished chrome plated gooseneck with vacuum breaker
- 3/8" NPT male inlet
- Nozzle has 3/8" NPSM female outlet with stream regulator



Model

No.	Spread	Height	Clearance
B-0405-02	5-5/8" (142 mm)	8-7/8" (226 mm)	4-1/2" (114 mm)
B-0405-03	8-9/16" (218 mm)	8-7/8" (226 mm)	4-1/2" (114 mm)
B-0405-04	11-5/8" (295 mm)	8-7/8" (226 mm)	4-1/2" (114 mm)

Note: Use Series 2 outlets on these goosenecks

Vacuum Breaker Swing Nozzle with Stream Regulator

- Nozzle has 3/8" NPSM female outlet with stream regulator
- Vacuum breaker swing nozzles can be supplied on T&S faucets instead of nozzles ordinarily furnished to meet local code requirements



Model

No.	Spread	Height
B-0408-02	5-5/8" (143 mm)	3-11/16" (94 mm)
B-0408-03	8-5/8" (219 mm)	3-11/16" (94 mm)
B-0408-04	11-5/8" (295 mm)	3-11/16" (94 mm)

Note: Use Series 2 outlets on these nozzles

OCS6 Swivel Cast Spout



- Polished chromium plated cast nozzle with aerator outlet



Model

No.	Length	Height	Clearance
OCS6	6" (152 mm)	2-3/8" (60 mm)	15/16" (24 mm)
OCS8	8" (203 mm)	5-3/16" (132 mm)	3-13/16" (96 mm)

OCS6-LT 6" (152 mm) with B-LT stream regulator  
 OCS8-LT 8" (229 mm) with B-LT stream regulator

Note: Use Series 2 outlets on these spouts

Swivel Vacuum Breaker Gooseneck

- 3/8" NPT male inlet
- Nozzle has 3/8" NPSM female outlet with stream regulator
- B-0406-02, -03, -04 Rigid polished chrome plated gooseneck with swivel vacuum breaker – swivels at vacuum breaker
- B-0407-02, -03, -04 Swivel polished chrome plated gooseneck with vacuum breaker – swivels at base



Model

No.	Spread	Height	Clearance
B-0406-02	5-5/8" (143 mm)	9" (229 mm)	4-11/16" (119 mm)
B-0406-03	8-5/8" (219 mm)	9" (229 mm)	4-11/16" (119 mm)
B-0406-04	11-5/8" (295 mm)	9" (229 mm)	4-11/16" (119 mm)
B-0407-02	5-5/8" (143 mm)	8-11/16" (221 mm)	4-3/8" (111 mm)
B-0407-03	8-5/8" (219 mm)	8-11/16" (221 mm)	4-3/8" (111 mm)
B-0407-04	11-5/8" (295 mm)	8-11/16" (221 mm)	4-3/8" (111 mm)

Note: Use Series 2 outlets on these goosenecks

Vacuum Breaker Swing Nozzle with Garden Hose Thread

- Nozzle has 3/4" garden hose thread outlet
- Vacuum breaker swing nozzles can be supplied on T&S faucets instead of nozzles ordinarily furnished to meet local code requirements



Model

No.	Spread	Height
B-0409-02	5-5/8" (143 mm)	3-11/16" (94 mm)
B-0409-03	8-5/8" (219 mm)	3-11/16" (94 mm)
B-0409-04	11-5/8" (295 mm)	3-11/16" (94 mm)

Note: Use Series 2 outlets on these nozzles

## Big-Flo Nozzles

**NEW MODELS!**

### Big-Flo Double Joint Nozzle

- Double-joint nozzle for Big-Flo faucets with 3/4" inlets

**116X** 24" (610 mm) double joint swing nozzle  
**117X** 12" (305 mm) front section of double joint swing nozzle

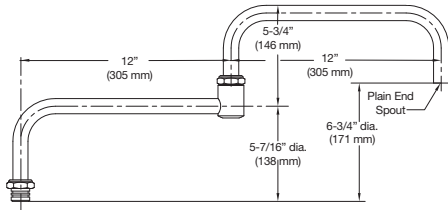

### Big-Flo Swing Nozzles

- For use with Big-Flo faucets with 3/4" inlets



Model No.	Standard Length	Standard Clearance	Standard Height
<b>114X</b>	12" (305 mm)	5-3/16" (132 mm)	8-5/8" (219 mm)
<b>115X</b>	18" (457 mm)	7-3/16" (183 mm)	10-5/8" (270 mm)

Note: No special outlets are available for these spouts

## Special Custom Goosenecks and Nozzles

### 002848-40 Range Faucet Nozzle

- 18" (457 mm) length, 12" (305 mm) front, 6" (152 mm) back



### B-2387 Swivel Gooseneck

- For use with swivel type base faucets
- Chrome plated
- 8-1/2" (216 mm) spread swivel gooseneck
- 10-1/8" (257 mm) total height
- Non-splash aerator (B-0199-01)
- Other dimensions available upon request



## Conversion Adapters

### B-0412 Adapter

- Rigid to swivel adapter
- Use for field conversion where a faucet with 3/8" NPT outlet is installed and a swivel gooseneck or nozzle is required
- Use two (2) 7X washers (000986-45) to make gooseneck or nozzle rigid



**B-0412-M** Master Box (2)

### B-0413 Adapter

- Swivel to rigid adapter
- Used for field conversion where a faucet with swivel outlet is installed and a rigid pipe gooseneck is required



**B-0413-M** Master Box (2)  
**B-0413-M50** Master Box (50)

### B-0414 Adapter

- Gooseneck coupling
- Adapts a 3/8" IPS pipe gooseneck to faucets with 3/8" IPS outlet providing either a swivel or union connection



**B-0414-M** Master Box (2)

### EZ-SWIVEL-CZ Swivel Adapter

- Swivel adapter for Chicago and Zurn faucets

### EZ-SWIVEL-FM Swivel Adapter

- Swivel adapter for Fisher faucets

D  
70

## Quick-Connect Coupling Set

### B-0452 Quick-Connect Coupling Set

- Chrome plated brass
- For use with water, air and non-corrosive gases
- When 1/4 NPT plug is removed from quick-connect socket, flow is automatically shut off

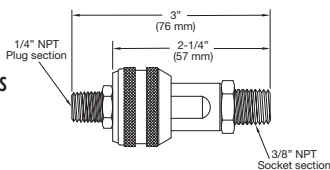

### B-0412-FXX Low Flow Adapter

New Water-Saving Adapter

- Rigid to swivel adapter with flow control tower
- Refer to "Flow Tower Chart" to specify flow desired and add numbers to model suffix
- 1"-20 UN male thread x 3/8"-18 NPT male thread
- For use on lavatory faucets to conserve water

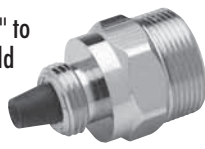

Model No.	Flow (GPM)
<b>B-0412-F03</b>	0.25
<b>B-0412-F05</b>	0.40
<b>B-0412-F07</b>	0.70
<b>B-0412-F10</b>	0.90
<b>B-0412-F12</b>	1.20
<b>B-0412-F15</b>	1.40
<b>B-0412-F16</b>	1.60
<b>B-0412-F20</b>	2.00

## Handles

### 001144-45 Alpine Handle

- Clear lexan handle
- Fits most T&S faucets
- Order chrome plated index buttons separately

001327-40 Cold Index  
001328-40 Hot Index  
001326-40 Blank Index



### 001784-40 Dome Handle

- Polished chrome zinc metal handle
- Conceals stem and bonnet
- Screw and index blue (cold) sold separately

001783-40 Dome handle, with red (hot) index sold separately



### B-WH4 Wrist Action Handle

- Chrome plated forged brass handle, 4" (102 mm) long
- Fits all T&S faucets
- Cold index: 001686-45
- Hot index: 001194-45
- Screw only: 000925-45
- Available with antimicrobial coating



**B-WH4H** Includes 4" handle, hot index button and screw  
**B-WH4C** Includes 4" handle, cold index button and screw  
**B-WH6** Same as B-WH4 except 6" (152 mm) long  
**B-WH6H** Includes 6" handle, hot index button and screw  
**B-WH6C** Includes 6" handle, cold index button and screw

### Push Button Handle

- Chrome plated handle for metering faucets
- Available with antimicrobial coating



014194-40 Hot, with vandal resistant screw and spanner bit  
014195-40 Cold, with vandal resistant screw and spanner bit  
014193-40 Blank, with vandal resistant screw and spanner bit

## Soap Dishes

### B-SD Soap Dish

- Chrome plated
- Must be used with soap dish nozzle or B-SDA soap dish assembly



### 001636-45 Lever Handle

- Chrome plated zinc handle
- Blue index button and screw (cold)
- Available with antimicrobial coating



001637-45 Lever handle with red index (hot) and screw  
001638-45 Lever handle with no index  
010027-40 Chrome plated solid brass handle

### 002521-45 Four Arm Handle

- Chrome plated zinc handle
- Order handle screw separately (000922-45)
- Available with antimicrobial coating
- Order index for hot or cold separately:



001660-45 Cold handle index (blue)  
001661-45 Hot handle index (red)

### Club Handle

- Chrome plated decorative handle

009332-41 Hot side  
009331-41 Cold side



### Pivot Action Metering Handle

- Chrome plated handle for pivot action metering faucets
- Available with antimicrobial coating



PA-H Hot, with retaining nut and spanner bit  
PA-C Cold, with retaining nut and spanner bit  
PA-B Blank, with retaining nut and spanner bit

### B-SDA Soap Dish Assembly

- Chrome plated
- Clamps onto 3/8" NPT goosenecks or risers



## Aerators

**NEW**  
Water-Saving  
Models!

**NEW!**

Check out our new water-saving aerators and outlets!

Series 1	Series 2	Series 3	Series 4	Series 5
<ul style="list-style-type: none"> <li>• 55/64"-27 UN female aerator threads</li> <li>• Fits all swing nozzles and 131X, 133X gooseneck</li> <li>• -WS models are water-saving aerators</li> </ul>	<ul style="list-style-type: none"> <li>• 3/8" NPSM male thread</li> <li>• Fits goosenecks</li> <li>• -WS models are water-saving aerators</li> </ul>	<ul style="list-style-type: none"> <li>• 13/16"-27 UN male aerator thread</li> <li>• Fits lavatory spouts</li> <li>• -WS models are water-saving aerators</li> </ul>	<ul style="list-style-type: none"> <li>• 15/16"-27 UN male thread</li> <li>• Fits single lever line</li> <li>• -WS models are water-saving aerators</li> </ul>	<ul style="list-style-type: none"> <li>• 13/16"-24 UN female thread</li> <li>• Fits other manufacturer's faucets</li> <li>• Includes adapter and washer with aerator</li> </ul>

### Standard Aerators

Aerator		Series 1	Series 2	Series 3	Series 4	Series 5
<ul style="list-style-type: none"> <li>• Non-splash aerator</li> </ul> 		<b>B-0199-01</b> (2.2 GPM)	<b>B-0199-02</b> (2.2 GPM)	<b>B-0199-03</b> (2.2 GPM)	<b>B-0199-04</b> (2.2 GPM)	

<ul style="list-style-type: none"> <li>• Vandal resistant, non-splash aerator</li> <li>• Use tool to attach and remove aerator</li> </ul> 		<b>B-0199-06</b> (2.2 GPM)	<b>B-0199-07</b> (2.2 GPM)	<b>B-0199-08</b> (2.2 GPM)	<b>B-0199-09</b> (2.2 GPM)	
---	--	-------------------------------	-------------------------------	-------------------------------	-------------------------------	--

### Water-Conserving Aerators

<ul style="list-style-type: none"> <li>• Non-splash aerator with flow control</li> </ul> 		<b>B-0199-01F-XX</b>	<b>B-0199-02F-XX</b>	<b>B-0199-03F-XX</b>		
<b>Refer to Aerator Flow Chart to add Suffix Numbers</b>						

<ul style="list-style-type: none"> <li>• Non-splash, vandal resistant aerator with flow control</li> <li>• Tool to attach and remove aerator</li> </ul> 		<b>B-0199-06F-XX</b>	<b>B-0199-07F-XX</b>	<b>B-0199-08F-XX</b>		
<b>Refer to Aerator Flow Chart to add Suffix Numbers</b>						

<ul style="list-style-type: none"> <li>• Non-splash aerator with flow control</li> </ul> 		<b>B-0199-01-WS</b> (1.5 GPM)	<b>B-0199-02-WS</b> (1.5 GPM)	<b>B-0199-03-WS</b> (1.5 GPM)	<b>B-0199-04-WS</b> (1.5 GPM)	<b>B-0199-05-WS</b> (1.5 GPM)
--	--	----------------------------------	----------------------------------	----------------------------------	----------------------------------	----------------------------------

<ul style="list-style-type: none"> <li>• Non-splash, vandal resistant aerator with flow control</li> <li>• Tool to attach and remove aerator</li> </ul> 		<b>B-0199-06-WS</b> (1.5 GPM)	<b>B-0199-07-WS</b> (1.5 GPM)	<b>B-0199-08-WS</b> (1.5 GPM)	<b>B-0199-09-WS</b> (1.5 GPM)	<b>B-0199-10-WS</b> (1.5 GPM)
---	--	----------------------------------	----------------------------------	----------------------------------	----------------------------------	----------------------------------

**NEW**  
Water-Saving  
Models!

**D**  
**72**

### Aerator Flow Chart

Flow (GPM)	Suffix	Color Code	Flow (GPM)	Suffix	Color Code
0.25	F03	No color	1.20	F12	Orange
0.40	F05	Brown	1.40	F15	Purple
0.70	F07	Green	2.00	F20	Yellow
0.90	F10	Grey			

GPM ± 10%

#### To order:

Select flow desired, then add suffix to model number.

For ex., B-0199-02**F15** for 1.40 GPM

#### Note:

Painted mark on each flow control within the assembly indicates flow of unit.

**Laminar Flow Outlets**



**NEW!**

Check out our new non-splash, non-aerated laminar flow devices!

		Series 1	Series 3	Series 4
<p><b>Laminar Flow Regulator</b></p> <ul style="list-style-type: none"> <li>• Non-splash, non-aerated stream</li> <li>• Screenless; for use in medical facilities to prevent airborne bacteria from entering water stream</li> </ul>		<ul style="list-style-type: none"> <li>• 55/64"-27 UN female aerator threads</li> <li>• Fits all swing nozzles, 131X, 133X gooseneck</li> </ul>	<ul style="list-style-type: none"> <li>• 13/16"-27 UN male aerator thread</li> <li>• Fits lavatory spouts</li> </ul>	<ul style="list-style-type: none"> <li>• 15/16"-27 UN male thread</li> <li>• Fits single lever line</li> </ul>
		<p><b>B-0199-21</b> (2.2 GPM)</p> <p><b>B-0199-29</b> (1.5 GPM)</p>	<p><b>B-0199-26</b> (2.2 GPM)</p>	<p><b>B-0199-25</b> (2.2 GPM)</p>
<p><b>NEW! Vandal Resistant Laminar Flow</b></p> <ul style="list-style-type: none"> <li>• Same as B-0199-21 except is vandal resistant with key</li> <li>• -VR - female thread</li> <li>• -VRF - female thread</li> <li>• -VRM - male thread</li> </ul>		<p><b>B-0199-29-VR</b> (1.5 GPM)</p> <p><b>B-0199-21-VRF</b> (2.2 GPM)</p> <p><b>B-0199-21-VRM</b> (2.2 GPM)</p>	<p><b>B-0199-28</b> (2.2 GPM)</p>	<p><b>B-0199-27</b> (2.2 GPM)</p>

**NEW! Non-Aerated Spray Devices**



NEW! Water-saving 0.35 GPM and 0.5 GPM flow rate

**NEW!**

Check out our new water-saving non-aerated spray devices with 0.35 and 0.5 GPM!

	Series 1	Series 2	Series 3	Series 4	Series 5
<p><b>Non-Aerated Spray Device</b></p> <ul style="list-style-type: none"> <li>• Non-splash non-aerated spray device</li> </ul>	<ul style="list-style-type: none"> <li>• 55/64"-27 UN female thread</li> <li>• Fits all swing nozzles, 131X, 133X gooseneck</li> </ul>	<ul style="list-style-type: none"> <li>• 3/8" NPSM male thread</li> <li>• Fits goosenecks</li> </ul>	<ul style="list-style-type: none"> <li>• 13/16"-27 UN male thread</li> <li>• Fits lavatory spouts</li> </ul>	<ul style="list-style-type: none"> <li>• 15/16"-27 UN male thread</li> <li>• Fits single lever line</li> </ul>	<ul style="list-style-type: none"> <li>• 13/16"-24 UN female thread</li> <li>• Fits other manufacturer's faucets</li> </ul>
	<p><b>B-0199-01-N035</b> (0.35 GPM)</p> <p><b>B-0199-01-N05</b> (0.5 GPM)</p>	<p><b>B-0199-02-N035</b> (0.35 GPM)</p> <p><b>B-0199-02-N05</b> (0.5 GPM)</p>	<p><b>B-0199-03-N035</b> (0.35 GPM)</p> <p><b>B-0199-03-N05</b> (0.5 GPM)</p>	<p><b>B-0199-04-N035</b> (0.35 GPM)</p> <p><b>B-0199-04-N05</b> (0.5 GPM)</p>	<p><b>B-0199-05-N035</b> (0.35 GPM)</p> <p><b>B-0199-05-N05</b> (0.5 GPM)</p>
<p><b>Vandal Resistant Non-Aerated Spray Device</b></p> <ul style="list-style-type: none"> <li>• Non-splash, vandal resistant non-aerated spray device</li> <li>• Tool to attach and remove outlet</li> </ul>					
	<p><b>B-0199-06-N035</b> (0.35 GPM)</p> <p><b>B-0199-06-N05</b> (0.5 GPM)</p>	<p><b>B-0199-07-N035</b> (0.35 GPM)</p> <p><b>B-0199-07-N05</b> (0.5 GPM)</p>	<p><b>B-0199-08-N035</b> (0.35 GPM)</p> <p><b>B-0199-08-N05</b> (0.5 GPM)</p>	<p><b>B-0199-09-N035</b> (0.35 GPM)</p> <p><b>B-0199-09-N05</b> (0.5 GPM)</p>	<p><b>B-0199-10-N035</b> (0.35 GPM)</p> <p><b>B-0199-10-N05</b> (0.5 GPM)</p>

## Outlets

### Series 1 Outlets

**NEW**  
Water-Saving  
Models!

- 55/64"-27 UN female aerator threads
- Fits all swing nozzles and 131X, 133X goosenecks

#### B-0103-01 Rosespray

- Female aerator thread
- Solid brass construction



#### B-GFE Garden Hose Outlet

- Female aerator thread
- Fits on end of nozzle or gooseneck to convert aerator male thread to male garden hose thread



#### B-PT Stream Regulator

- Female aerator thread
- Plain outlet with screen and washer



#### B-0199-22 Swivel Aerator

- 55/64"-27 UN female inlet
- Includes 15/16"-27 UN male adapter
- Swivel outlet
- 2.2 GPM
- Dual spray pattern: aerator or rosespray



#### B-0199-VR-KEY Pro Key

**NEW**  
Vandal-Resis-  
tant Key!

- Pro key for vandal-resistant aerators



### Series 2 Outlets

**NEW**  
Water-Saving  
Models!

- 3/8" NPSM male thread
- Fits goosenecks

#### B-0103 Rosespray

- Solid brass construction
- 4 GPM
- 3/8" NPSM male thread

**NEW** water-saving models available:

**B-0103-Fxx** models with flow control assembly and 3/8"-18 NPT male thread – refer to Flow Tower Chart at right to specify flow desired and add numbers to model suffix



#### Flow Tower Chart

Model No.	Flow (GPM)
B-0103-F03	0.25
B-0103-F05	0.40
B-0103-F07	0.70
B-0103-F10	0.90
B-0103-F12	1.20
B-0103-F15	1.40
B-0103-F20	2.00

#### B-0198-FXX Series Serrated Hose End

- 3/8" NPT male inlet thread
- Serrated hose end accepts rubber or plastic tubing up to 1/2" I.D.
- Refer to Flow Tower Chart below to specify flow desired and add numbers to model suffix



#### Flow Tower Chart

Model No.	Flow (GPM)
B-0198-F03	0.25
B-0198-F05	0.40
B-0198-F07	0.70
B-0198-F10	0.90
B-0198-F12	1.20
B-0198-F15	1.40
B-0198-F20	2.00

**For Serrated Hose End**

**To order:**  
Select flow desired, then add suffix to model number.

Ex.: B-0198-**F03** for 0.25 GPM

#### B-GH Garden Hose Outlet

- 3/8" NPSM male x garden hose male adapter



#### B-LT Stream Regulator

- 3/8" male thread
- Plain outlet





## Adapters, Inlets, Supply Connectors and Parts Kits

### Adapter Chart

Dimensions				Model
3/8 NPSM	male	x 3/4-11 1/2 G.H.	male	<b>B-GH</b>
1/2 NPT	male	x 3/8 NPT	female (Face bushing)	<b>002337-45</b>
1/2 NPT	male	x 3/8 NPT	female (Hex bushing)	<b>001359-40</b>
3/4-14	male	x 1/4 NPT	male (Fisher adapter)	<b>002584-25 (172A)</b>
3/4-14	male	x 1/4 NPT	female	<b>000544-25 (52A)</b>
3/4-14	male	x 3/8 NPT	male (Chicago adapter)	<b>000545-25 (53A)</b>
3/4-14	male	x 3/8 NPE	female (Hex stock)	<b>000546-25 (54A)</b>
3/4 G.H.	female	x 1/2 NPT	male	<b>003105-40</b>
3/4-14	male	x 5/8-27	female	<b>000552-25</b>
3/4-14	male	x 3/4 NPT	male	<b>000549-25 (57A)</b>
3/4-14	male	x 3/4 NPT	female	<b>000550-25 (58A)</b>
3/4-14	male	x 3/4-14	male	<b>001806-25 (98A)</b>
55/64-27	male	x 1/8 NPT	female	<b>001624-25</b>
55/64-27	male	x 5/8-27	female	<b>000554-25</b>
55/64-27	female	x 3/4-11 1/2 G.H.	male	<b>B-GFE</b>

### 150A Union Coupling Tailpiece

- 1/4" NPT tailpiece with nut fits 1/2" NPT and NPS faucet shanks with 30" tapered inlet

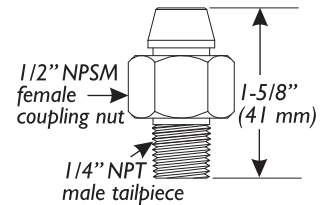

### 006895-20 Short Elbow

- 1/2" female connectors
- Used with 1/2" male threaded supplies to provide 90° turns at inlets



## Inlets and Supply Connections

### B-0425 Supply Nipple

**B-0425-M** Master Box (2)

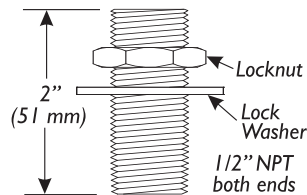

### B-0426 Supply Nipple

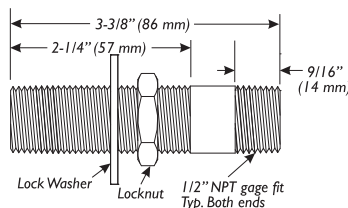

### B-0427 Supply Nipple

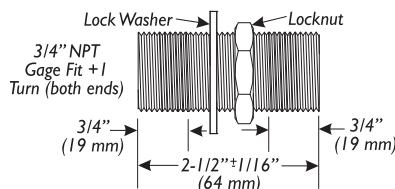

### B-0428 Supply Nipple

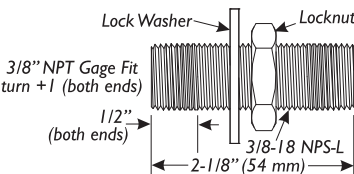

### B-0429 Supply Nipple

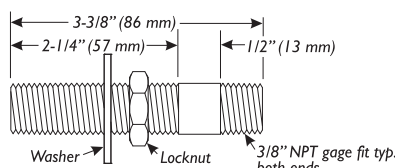

### B-0230-K Parts Kit

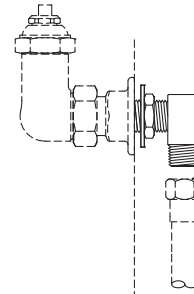

- Parts included:  
1/2" NPT Supply nipple, lock nut and washer  
1/2" NPT Male x Female short EL

### B-1100-K Parts Kit

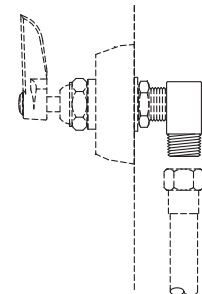

- Parts included:  
1/2" NPT Male x Female short EL

### B-0230-KIT Parts Kit

- Parts included:  
2 1/2" inlet shanks and close elbows –inlet assembly kit (2 sets per kit)  
1 24" flexible supply hose (two sets per kit)

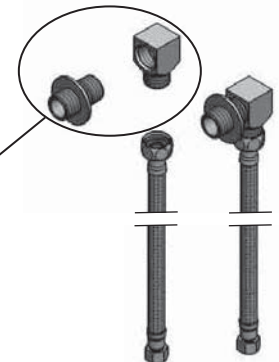

Supply Nipple	Length
3/8" <b>B-0428</b>	2-1/8" (54 mm)
<b>B-0429</b>	3-3/8" (86 mm)
1/2" <b>B-0425</b>	2" (51 mm)
<b>B-0426</b>	3-3/8" (86 mm)
<b>B-0427</b>	2-1/2" (64 mm)

These red brass supply nipples have tapered pipe threads on each end and a running thread between. They are used on faucets with female inlets to make up tightly to vertical or horizontal surfaces. Washer and nut included. Available in chrome if specified.

## Risers and Connectors

### 3/8" Riser Lengths

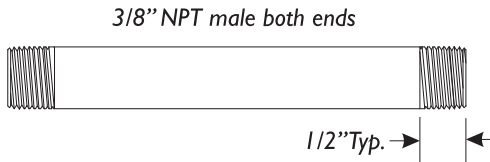

Model No.	Length	Model No.	Length
000357-40	2" (51 mm)	000369-40	18" (457 mm)
000358-40	3" (76 mm)	000372-40	24" (610 mm)
000361-40	5" (127 mm)	000376-40	32" (813 mm)
000363-40	7" (178 mm)		

Contact factory for sizes not shown.

### Couplings

- Used to connect two (2) pipes
- Same thread size on both ends

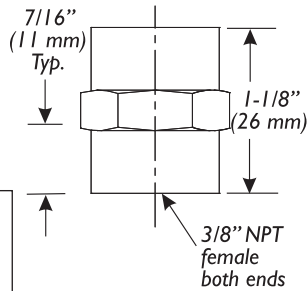

Dimension	Model No.
3/8" NPT female	001769-40
3/4-14 NPT female	001596-25

### Elbows and Tees

#### 148X

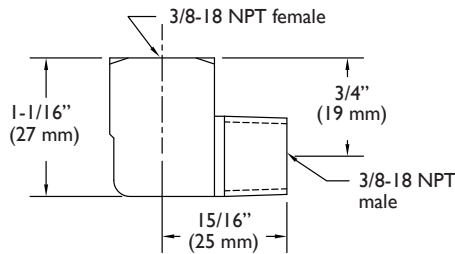

#### 001355-40

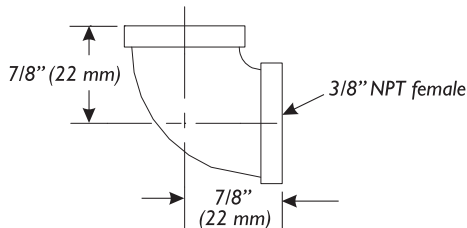

#### 00LL

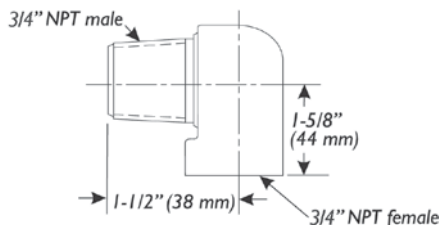

### Close Nipples

- Used to connect two (2) pipes
- Male x male
- Same thread size on both ends
- Close nipple will be completely concealed

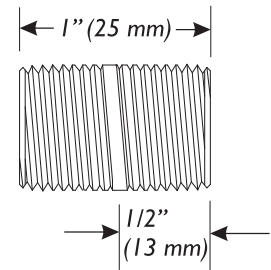

Dimension	Model No.
3/8" NPT male	002535-25
1/2" NPT male	002534-25

### B-CVV1-2 Check Valve

- Rough brass finish
- Chrome plated available upon request
- Designed for water use only



**B-CVH1-2** for horizontal or vertical use, 1/2" NPT female  
**B-CVH3-4** for horizontal or vertical use, 3/4" NPT female  
 Furnished in rough brass

#### 150X

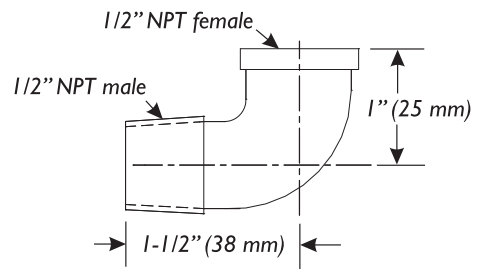

### Elbows

Description	Model No.
3/8" Street elbow	148X
3/8" Elbow	001355-40
1/2" Short elbow	006895-20
1/2" Street elbow	150X
1/2" Elbow	001357-40
3/4" Short elbow	00LL
3/4" Elbow	001720-40

## Inlet Product Options

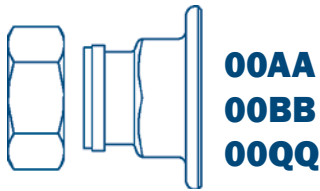

**00AA**  
**00BB**  
**00QQ**

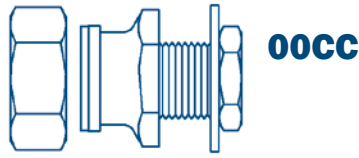

**00CC**

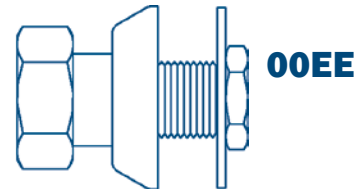

**00EE**

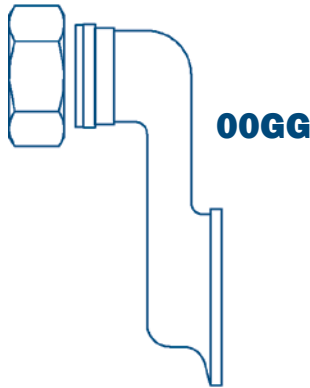

**00GG**

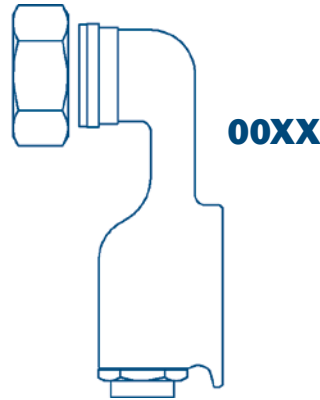

**00XX**

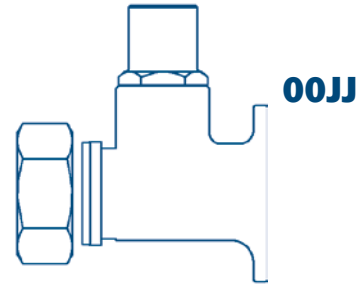

**00JJ**

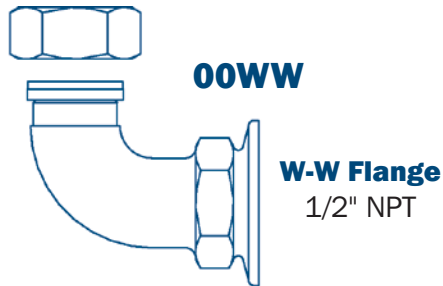

**00WW**

**W-W Flange**  
1/2" NPT

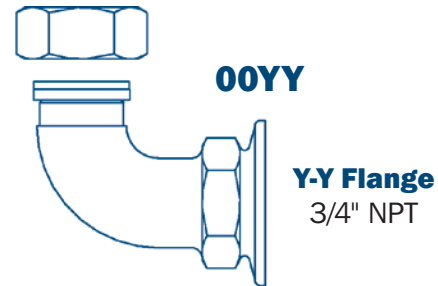

**00YY**

**Y-Y Flange**  
3/4" NPT

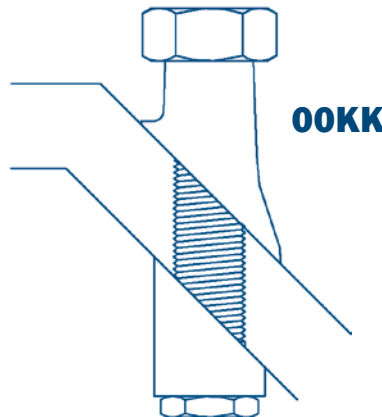

**00KK**

For use with  
deck  
at 45° angle  
Max. countertop  
thickness 1"

### Union Coupling Inlets

The following inlets are polished chrome plated and used on mixing faucets to meet varying conditions of installation. All are interchangeable and are used in lieu of the "00AA" inlets which are ordinarily furnished on faucets using union coupling inlets. All are available in rough chrome if specified. To order, add suffix letters to faucet model number. For example: "B-0230-CC" – Sink mixing faucet with 1/2" NPT male inlet, 1" (25 mm) long.

- 00AA** 1/2" NPT female eccentric flanged inlet
- 00BB** 3/4" NPT female eccentric flanged inlet
- 00CC** 1/2" NPT male inlet, 1" (25 mm) long
- 00EE** 1/2" NPT male inlet with adjustable flange, 1" (25 mm) long
- 00GG** 1/2" NPT female flanged adjustable inlet
- 00XX** 1/2" NPT female flanged adjustable inlet with screwdriver stop
- 00JJ** 1/2" NPT female inlet with loose key stop
- 00WW** 1/2" NPT female flange 90° inlet
- 00YY** 3/4" NPT female flange 90° inlet
- 00KK** 1/2" NPT male inlet for use on 45° decks. Inlet is at 45° angle to mounting face.
- 00QQ** 3/8" NPT female eccentric flanged inlet

**Inlet Extensions**

**B-0440**

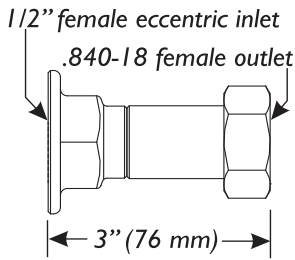

**B-0441**

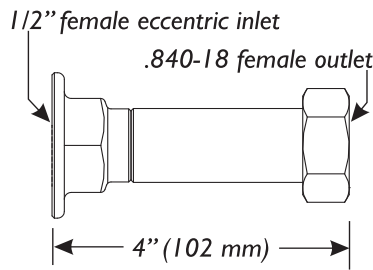

**B-0442**

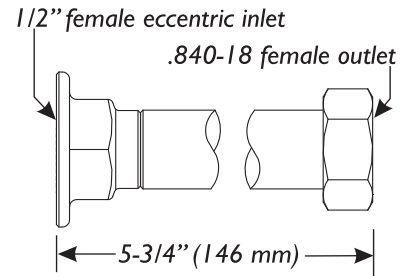

**B-0443**

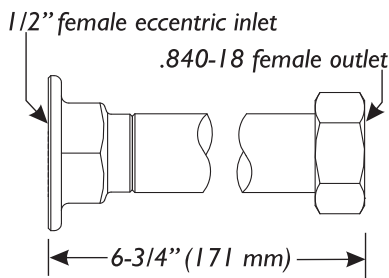

**B-0445**

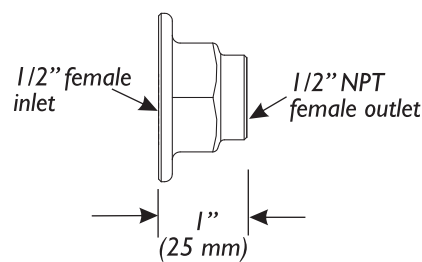

**B-0446**

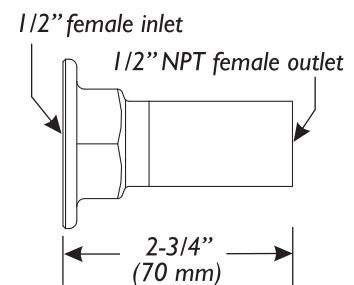

**B-0447**

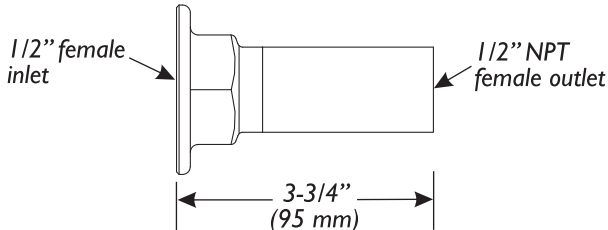

**B-0448**

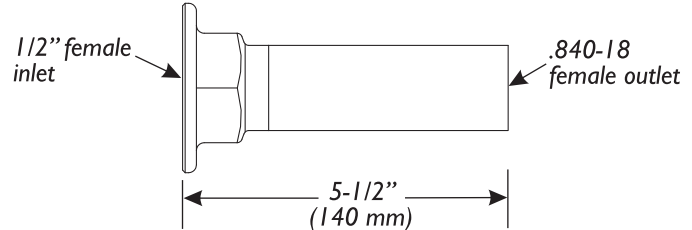

**B-0449**

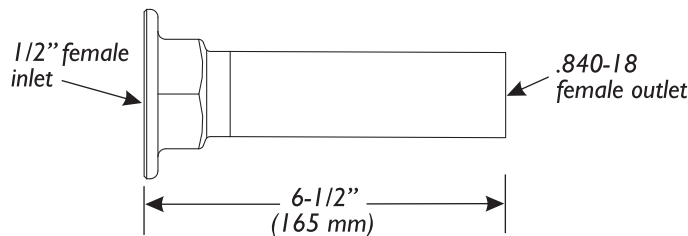

Note: .840-18 female outlet accepts insert (000684-20) which connects inlet extension to faucet body

**Inlet Extensions**

The following inlet extensions are polished chrome plated and used on the inlets of either wall or deck mounted union coupling style mixing faucets to extend inlets. 00AA 1-1/4" (32 mm) inlet standard on typical wall mounted faucets (B-0230, for example).

- B-0440** Adds 1-3/4" (44 mm) to standard 00AA
- B-0441** Adds 2-3/4" (70 mm) to standard 00AA
- B-0442** Adds 4-1/2" (114 mm) to standard 00AA
- B-0443** Adds 5-1/2" (140 mm) to standard 00AA

The following inlet extensions are used to extend faucets with male 1/2" NPT inlets.

Ex.: B-0704 faucet with B-0447 inlet extension.

- B-0445** 1" (25 mm)
- B-0446** 2-3/4" (70 mm)
- B-0447** 3-3/4" (95 mm)
- B-0448** 5-1/2" (140 mm)
- B-0449** 6-1/2" (165 mm)