

# SERVER

• E S S E N T I A L S •

## Back to better basics.

Refined products for even greater reliability and value.

2024 PRODUCT PORTFOLIO





# A legacy of indispensable foodservice products.

From one generation to the next, we design and build smart, reliable products that serve you and your customers better. Server Essentials takes our legacy products into an exciting future focused on speed, consistency and simplicity. And while our product portfolio has undergone a purposeful refresh, our commitment to you continues to be at the forefront of our daily operations. Discover how the next generation of foodservice equipment can help your business grow like never before.

## Our core commitments.

- Exceed **speed of service** expectations for every order, every time.
- Deliver **efficiency** by reducing training and optimizing the experience.
- Ensure **consistency** and the same exceptional food and beverage experience every time.
- Intuitive **simplicity** for back-of-house simplicity.



Available  
online,  
anytime.

Now you can purchase Server dispensing, holding and warming solutions and replacement parts from your favorite e-commerce supplier. Simply click to visit the online storefront and see what's available today.

## Pumps & Dispensers 4

- Pump Selection Guide**
- Food Container Pumps
- Food Pan & Jar Pumps
- Fountain Jar Pumps
- Inset Pumps
- Specialty Dispensers

## Stations 22

- Station Selection Guide**
- Squeeze Bottle Holders
- Pouched Food Stations
- Tiered Stations
- Cold Stations
- Mini Station
- Mini Station Creation Guide**
- Fountain Jar Stations
- Station Creation Guide**

## Warmers 42

- Soup Warmers
- Topping Warmers
- Specialty Warmers featuring ConserveWell® Heated Utensil Holderson page 56

## Dry Dispensers 58

- Dry Dispenser Selection Guide**
- Sweetener & Seasoning
- Food & Candy

## Parts & Pricing 64

- Parts & Service
- Warmer Parts
- Pump Parts
- Price Guide**

**ONLINE CHAT SUPPORT**  
[server-products.com](http://server-products.com)

**PHONE**  
800.558.8722 | 262.628.5600

**DOMESTIC EMAIL (USA)**  
[spsales@server-products.com](mailto:spsales@server-products.com)

**INTERNATIONAL EMAIL**  
[international@server-products.com](mailto:international@server-products.com)

**ADDRESS**  
3601 Pleasant Hill Road, Richfield WI 53076



# Pumps & Dispensers

## Getting fresher with age.

From the very beginning, we've tried to think differently when it comes to helping you serve better and we're still thinking that way today to ensure staff and patrons have a safe and sanitary solution for delivering the flavors they love. It's just another way we are helping you bring out flavor in its freshest form.

**2** YEAR WARRANTY

Server Pumps & Dispensers are backed by a two-year warranty.

### Pump Selection Guide

8

#### Food Container Pumps



10

#### Fountain Jar Pumps

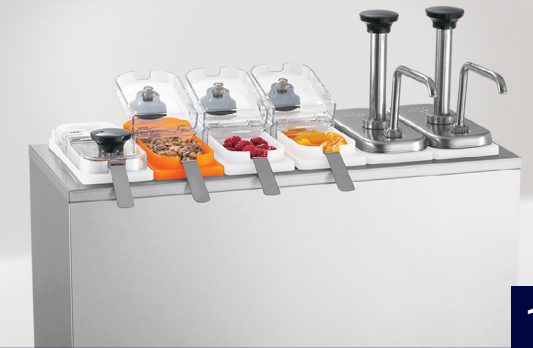

18

#### Food Pan & Jar Pumps



16

#### Inset Pumps



20

#### Specialty Dispensers



20

 [Visit our online resource](#)

 [Consult your rep or find a dealer](#)

 [Get in touch](#)

**HOW TO BUY**



# Making sustainable dispensing indispensable.

Earth's resources aren't endless. That's why Server works hard to find new ways to reduce waste, control portions and make the most of each resource we're given. Our pumps aren't disposable – instead, we designed them to be durable, reliable and easy to clean, so you can keep pumping out more delicious flavor without wasting a single drop.

**VERSATILITY**  
Perfect fit for back-of-house creations to front-of-house serving stations.

**PORTION CONTROL**  
Not too much and not too little – just consistently full of flavor.

**WASTE REDUCTION**  
Control costs and squeeze every last drop out of your pump.

## Make the right choice.

Choosing the proper pump prevents operational issues such as overserving, dripping product and overworking (unnecessary force needed to serve). Whether dispensing from original food containers or large, eco-friendly pouches, no one else crafts foodservice pumps quite like we do. Plus, we make it easy to find the perfect pump for your operation. Check out our [Pump Selection Guide on page 8](#) or find additional tips on selecting the proper equipment by learning more with our exclusive [online resources](#).

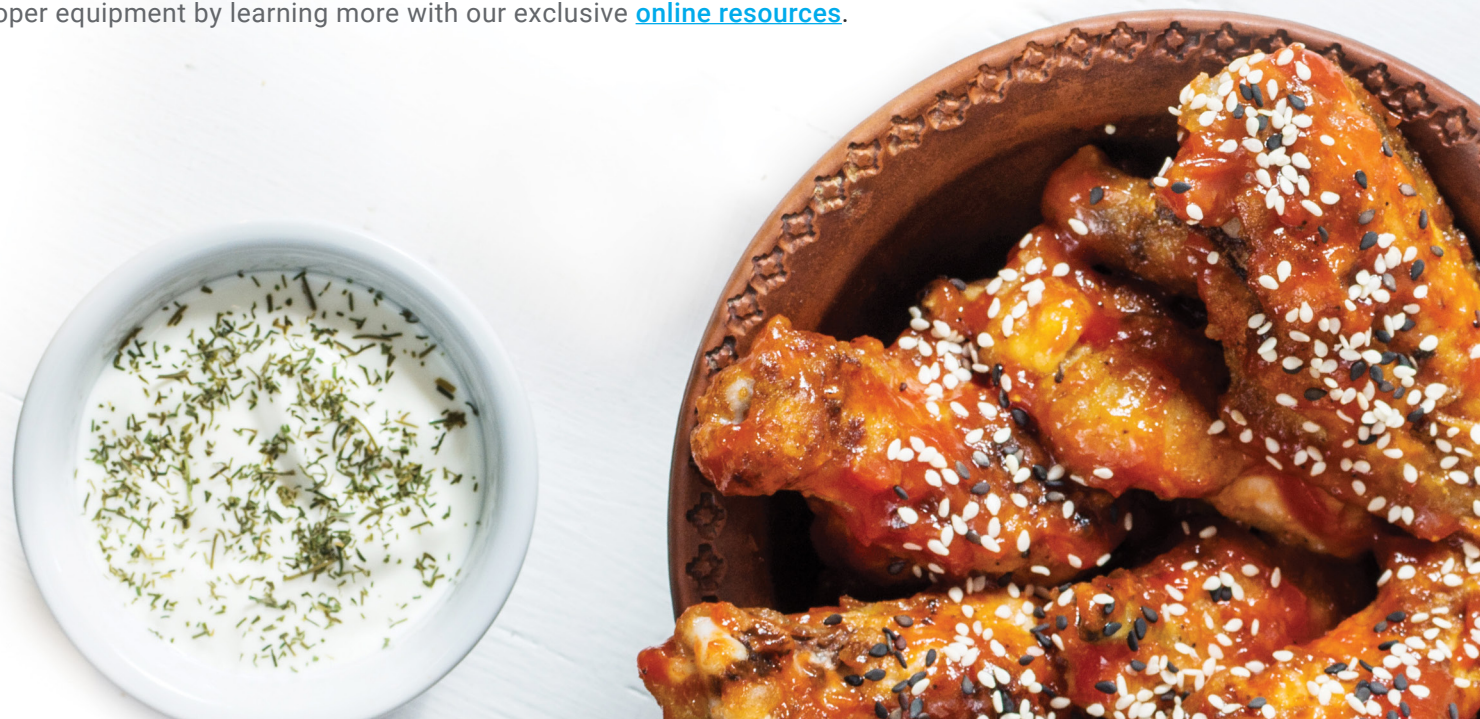

## Fraction Control

Server pumps dispense precise portions every time, providing you ultimate cost control. By reducing your portion size by just an eighth of an ounce, which will have no perceivable impact on patron experience, Portion Optimization™ savings can really add up. In this example, a single stainless steel pump that lists for \$215 pays for itself in just under six months. Now multiply the annual savings times the number of ingredients you serve every day and you'll start to see a significant impact on your bottom line! Start saving today by connecting with your local Server representative at [server-products.com/How-to-Buy](http://server-products.com/How-to-Buy).

### Portion Optimization™ Savings

Reduction Size 1/8 oz (.125 oz)	1 oz	7/8 oz
Cost Per Serving	\$0.10	\$0.0875
Servings Per Day	x 100	x 100
Operating Days Per Year	360	360
Annual Flavor Cost	\$3,600	\$3,150

**Annual Savings \$450**



“I can't recall a single complaint.”

Tom Marranca has been an equipment and supply manager for Dairy Queen® for 38 years. In his time supplying Server Pumps and Warmers to locations throughout Canada, he says he receives so few issues with the products, he doesn't remember any complaints. Not only are our pumps built to last – we build long-term relationships to ensure customer satisfaction.

“Thank you for your continued attention to service and quality.”



# Pump Selection Guide

Your quick and easy path to finding the perfect pump.



**Stainless Steel**  
See [p.9](#)



**Eco Pumps™**  
See [p.11](#)



**Server Express® Dispensers**  
See [p.13](#) and [p.17](#)

**PUMP STYLE\***

**KEY BENEFIT**

**APPLICATION**

AMBIENT	✓	✓	✓
COLD	✓	✓	
HOT	✓		

**WHAT ARE YOU DISPENSING?**

<b>THIN</b> fountain syrups • oils • hot sauce	The food's consistency influences which style pump is most applicable (what size and shape discharge tube will work for your application). The icons will help guide you to the proper pump, so you don't end up with dripping or overworking (unnecessary force needed to serve).		
<b>THICK</b> ketchup • mustard • mayonnaise • bbq	Express and Solution™ pumps include (3) discharge fittings with varying size openings to accommodate different product consistencies. <a href="#">This blog post can help you determine the best discharge fitting size for the food you're serving.</a>		
<b>THICKER</b> tartar sauce • crafted sauces			

**CONTAINERS**

**PORTION**

**FLAVOR ID**

Models to fit food containers, hot and cold table pans, vegetable insets, fountain, slim and mini jars (1/4-size)	Models serve from original food containers with 28- or 38-mm threads or mini jars (1/4-size)	Pouch models work with 1 1/2-gal or 96-oz pouches with 16-mm fitment; Direct-Pour Models include 1.3-gal jar (See <a href="#">p.17</a> )
Max 2 oz (select models), or 1 1/4-oz; reduce in 1/8-oz increments; allowing Portion Optimization™	Max 1 oz; reduce in 1/8-oz increments. BP-1/2 and BP-1/4 have fixed portions	Max 1 oz; reduce in 1/4-oz increments
Choose from (9) pump knob colors with custom text options at time of order	Original food packaging or sourced independently	Downloadable templates for custom graphics; magnet friendly

\*Pumps shown represent general "family" traits to help narrow selection to a specific model

**Looking for a recommendation?**  
**Try the Interactive Pump Finder on our website!**

# Stainless Perfection

**Interchangeable engraved and colored knobs help staff and patrons identify contents, coordinate with store themes or promote branded products. Specify color\* and text at time of order. See [p.76](#) and [p.77](#) for part numbers.**

\*Exact shade may vary from picture

**Portion Optimization™ uses additional gauging collars to deliver consistent portion control in 1/8-oz increments up to 2 oz.**

**Setting the standard for durability, stainless steel provides years of service; replacement parts ensure you never have to buy a complete pump again.**

**NSF listed and clean-in-place certified, these pumps reduce environmental impact as they never need to be discarded.**

**Stainless Steel Pumps**



# Food Container Pumps

## Stainless Steel Pumps

- Dispense dressings and sauces directly from widemouthed gallon jars, #10 or #5 cans
- Manage food costs with consistent servings; 1 oz per stroke, adjustable in 1/8-oz increments
- NSF listed, clean-in-place certified or disassemble for cleaning



SEE TABLE FOR APPLICABLE TRAITS BY MODEL

DISPENSES KEY

- THIN  
fountain syrups • oils • hot sauce
- THICK  
ketchup • mustard • mayo • bbq
- THICKER  
tartar sauce • crafted sauces

APP KEY

- AMBIENT
- COLD
- HOT

## Eco Pumps™

- The choice of chains for a smart alternative to disposable pumps
- Perfect for smooth ingredients like drink syrups, concentrates, ketchup and hot sauce with containers as short as 7" (17.8 cm)
- BP-1 Thick model with 1/2" discharge tube reduces dispensing force needed for thick, crafted ingredients
- Manage food costs and customer experience with precise portions; 1-oz models adjust in 1/8-oz increments
- NSF listed and clean-in-place certified for proper cleaning without disassembly



dispenses	model/item	application	pump & lid fit	full portion	height (above cont.)	weight
	<a href="#">SP 82000</a>		#10 can or 3-qt jar (94009)	1 oz	5 5/8"	3 lb
	<a href="#">CP-10 83000</a>		gallon jar, 3 1/2" (89 mm) threads			
	<a href="#">CP-G 83130</a>		gallon jar, 4 3/8" (110 mm) threads (fits jar 83122; not included)	1 oz	4 1/2"	3 lb
	<a href="#">CP-G 83120</a>		gallon jar, 4 3/4" (120 mm) threads			
	<a href="#">CP-G 83110</a>					
	<a href="#">SS-1 67580</a>		base hides gallon jar, #10 can or 3-qt jar (94009 sold separately)	1 oz	14 1/2" H x 6 7/8" W x 11 7/16" D	7 lb
	<a href="#">SS-1L 67590</a>				14 1/2" H x 6 7/8" W x 12" D	8 lb

NOTE: To determine container size, remove lid and measure space of opening including threads

dispenses	model/item	application	pump & cap fit (container not incl.)	full portion	height (above cont.)	weight
	<a href="#">BP-1 88000</a>		Fits bottle with 1 1/2" (38 mm) threads or 1 L bottle (88471) shown with pump (sold separately)	1 oz	5 1/4"	1 lb
	<a href="#">88471 (bottle &amp; cap only)</a>		1 L bottle with storage cap, 1 1/2" (38 mm) threads		10 1/4" tall	
	<a href="#">BP-1 Thick 88220</a>		Fits bottle with 1 1/2" (38 mm) threads or 1 L bottle (88471) shown with pump (g) sold separately	1 oz	5 7/8"	1 lb
	<a href="#">BP-1/4 88180</a>		bottle, 1 1/8" (28 mm) threads	1/4 oz, fixed	3 11/16"	1 lb
	<a href="#">BP-1/2 88190</a>			1/2 oz, fixed	5 9/16"	

NOTE: To determine container size, remove cap and measure space of opening including threads

## Stainless Steel Dispensers

- Provide a clean presentation; dispense from original container from within shroud
- Coordinate pump knob with store theme, branded product or contents within; specify color and text when ordering; black is standard (see p.9 for details)
- Model SS-1L includes a hasp to lock the lid and base together (lock not included)

Shown with custom graphics. Download templates at [Server-Products.com](#)



## Rack 'em up.

Save space with WireWise® organizers and Eco Pumps™ to serve three flavors in less than 7" of countertop space.

Organizers are featured on [p.30](#)





# Food Container Pumps

## Pouch-Connect, Fountain Jar Pumps

- Serve toppings from popular 48-oz pouches with a 16-mm centered fitment in your heated cabinet, station or well for fountain jars
- Ideal for toppings that become thin when heated, like fudge and caramel or private-label sauce
- Models for standard countertop and slanted countertop or drop-in use; drop-in (DI) model has a higher discharge point for additional serving clearance
- Portions adjust in 1/8-oz increments with 1-oz max per stroke
- Saves labor and reduces cleaning time – toppings are contained within the pouch and pump
- Specify color and text for pump knob when ordering; black is standard (see p.9 for details)



dispenses	model/item	application	description	pump & lid fit (jar not incl.)	full portion	4 1/2" W x 7 1/8" D x H above	dp	weight
a	EPEC-200V 82740		serve from (1) 48-oz pouch in a shallow fountain jar; countertop use	7 1/2" fountain jar (white 82558, black 83147, orange 83148)	1 oz	6 1/4"	4 1/2"	2.1 lb
b	EPEC-200 82800		serve from (1) 48-oz pouch in a shallow fountain jar; angled discharge, countertop use				2 7/8"	

## Pouched and pumped for speed.

Flexible packaging is ideal in fast-paced, institutional and quick-serve restaurants. The 48-oz bag fitment connects directly to the dispenser for an operator-friendly system that streamlines workflow so you can server better, faster.



## Express Dispensers | 1 1/2-Gallon Pouch

- Perfect for high-traffic, self-serve applications – serves from popular 1 1/2-gallon condiment and dressing pouches with a 16-mm fitment
- Sealed, sanitary system achieves up to 98% evacuation; dispenses 1-oz max portion, reduce in 1/4-oz increments
- Cleanup is easy; condiments are contained within the pouch and surgical-quality plastic, six-piece pump
- Brushed finish stainless steel and black thermoset plastic vessels reduce the visibility of fingerprints



1 1/2-gallon pouch with 16-mm fitment



NSF listed pump (07794) uses only (6) parts

**NEW Direct-Pour models (no pouch needed) to serve 1.3 gallons of house-made sauces and condiments; see p.17 for details**

dispenses	model/item	application	description	full portion	dimensions (HxWxD)	weight
c	SE 07010		round, black plastic base with pump (07794); countertop & drop-in	1 oz	17 7/8" x 9 5/8" x 14"	8 lb
	SE-Single 07000		black plastic base with pump (07794); countertop & drop-in		17 5/8" x 7 1/2" x 14"	
d	SS-1SE 67760		07000 above & stainless steel shroud; countertop	1 oz	17 3/4" x 7 1/2" x 14"	11 lb
	SS-2SE 07300		(2) 07000s & stainless steel shroud; countertop		17 3/4" x 15" x 14 1/8"	18 lb
e	SE-SS 07125		stainless steel base with pump (07794); countertop	1 oz	17 9/16" x 6 3/8" x 13 1/4"	9 lb
f	SE-SS 07020		stainless steel base with pump (07794); drop-in		10 1/2" x 6 3/8" x 13 5/8"	

## More Express Dispenser options.

Express Stations combine multiple dispensers in a single base; see p.29 for details.



SEE TABLE FOR APPLICABLE TRAITS BY MODEL

**DISPENSES KEY**

- THIN  
fountain syrups • oils • hot sauce
- THICK  
ketchup • mustard • mayo • bbq
- THICKER  
tartar sauce • crafted sauces

**APP KEY**

- AMBIENT
- COLD
- HOT



# Food Container Pumps

## Extreme™ Dispenser | 3-Gallon Pouch

- Take high-volume condiment operations to the Extreme™ – tap into/serve from a 3-gallon pouch with 38-mm connector
- Countertop model needs no installation, is manually operated and has excellent evacuation
- Lever dispenses a 1-oz portion, which can be reduced in ¼-oz increments
- Saves labor and reduces cleaning time – condiments are contained within the pouch and pump

NSF **ADA** compliant | Less than 5 lbs of pressure to dispense



NSF listed pump (07518) has only (8) parts

3-gallon pouch with 38-mm connector

dispenses	model/item	application	description	full portion	dimensions (HxWxD)	weight
	ECD.07500		stainless steel base, black plastic hinged lid with pump (07518); countertop	1 oz	12 1/8" x 10 3/16" x 22 13/16"	14 lb

There are more options than ever for pouches of condiment and dressing brand favorites. Contact your broadliner or food supplier for SKU numbers and ordering information. [Click to learn more.](#)

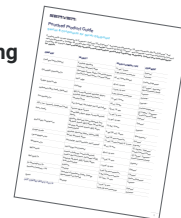

## Remote Pouched Dispensing Systems

- Racking design accepts 1 ½- and 3-gallon pouches, keeping condiments on tap and out of sight
- Manually operated system simplifies high-volume dispensing; eliminates the hassles of a CO<sub>2</sub>-driven dispenser
- 1-oz stroke; adjustable in ¼-oz increments
- Specify color and text for pump knob when ordering; black is standard (see p.9 for details)
- NSF listed, clean-in-place certified or disassemble for cleaning at a dish station; no tools necessary

NSF



Quick Connect System makes reserve pouch transitions easy and mess-free.

Flush-mounted, stainless steel pump connects either pouch style, forming a sealed and sanitary system.



1 1/2-gallon pouch with 16-mm fitment

3-gallon pouch with 38-mm connector

dispenses	model/item	application	description	full portion	dimensions (HxWxD)	weight
	CP-RP 85783		dispense from (1) 1 1/2- or 3-gallon pouch below counter; single support	1 oz	9 9/16" x 4 1/2" x 11 1/4" (above counter)	12 lb

SEE TABLE FOR APPLICABLE TRAITS BY MODEL

**DISPENSES KEY**

- THIN**  
fountain syrups • oils • hot sauce
- THICK**  
ketchup • mustard • mayo • bbq
- THICKER**  
tartar sauce • crafted sauces

**APP KEY**

- AMBIENT**
- COLD**
- HOT**



# Food Pan & Jar Pumps

## Stainless Steel Pumps | 1/3-, 1/4-, 1/6-Size Pans

- Dispense marinara sauces, gravies and more from your fractional food pans; 6" deep
- Precise portions control food costs and ensure flavor consistency; 1-oz max portion adjusts in 1/8-oz increments
- Models with larger 2-oz stroke improve back-of-house efficiency; adjust to serve 1 3/4, 1 1/2 or 1 1/4 oz with included collars
- Coordinate pump knob with store theme or contents within; specify color and text when ordering (see p.9 for details)
- NSF listed, clean-in-place certified or disassemble

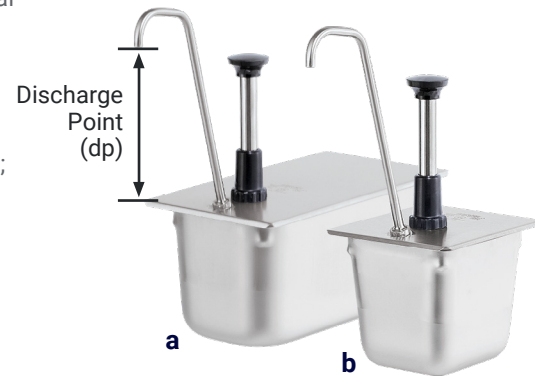

Tall models have 3" taller spouts for additional serving clearance.



	dispenses	model/item	application	pump & lid fit (pan not incl.)	full portion	dim. above pan (HxWxD)	dp	weight
a		CP-1/3 83430		1/3-size, 6.1-qt food pan (90083); use Tall model for drop-in	1 oz	6 1/4" x 7 1/8" x 13 1/16"	4 5/8"	3 lb
		CP-1/3 Tall 83441			2 oz	9 1/16" x 7 1/8" x 13 1/16"	7 5/8"	
		CP-1/3 2 oz 87640			2 oz	7 1/4" x 7 1/8" x 13 1/16"	4 5/8"	
b		CP-1/4 83420		1/4-size, 4.5-qt food pan; use Tall model for drop-in	1 oz	6 1/4" x 6 5/8" x 10 1/2"	4 5/8"	3 lb
		FP-1/6 86312			1 oz	6 1/4" x 6 7/16" x 7 1/16"	3 1/8"	
		CP-1/6 83400			1 oz	9 1/16" x 6 7/16" x 7 1/16"	4 5/8"	
		CP-1/6 Tall 83433				9 1/16" x 6 7/16" x 7 1/16"	7 5/8"	

Doing double serving lines? Models for 1/2-size (long) pans include (2) pumps. Visit [server-products.com](http://server-products.com) for details.

## 1/9-Size Jar Pumps

- 1/9-size jars and coordinating pumps fit cold tables or countertop stations; wherever 1/9-size pans are used
- Designed with food types in mind – pumps for thin syrups or thick concentrates
- 1-oz portion per stroke is adjustable in 1/8-oz increments
- Identify contents with a colored, engraved pump knob; black is standard (see p.9 for details)
- Create a Mini Station with 3-4 pumps; see component guide featured on p.33



	dispenses	model/item	application	pump & lid fit (jar not incl.)	full portion	dim. above jar (HxWxD)	weight
c		FP-1/9 87310		1/9-size jar, 60 oz (87203 black, 87195 orange); use Tall model for drop-in	1 oz	5 13/16" x 3 15/16" x 6 1/4"	2 lb
		CP-1/9 87300			1 oz	5 13/16" x 3 15/16" x 6 1/4"	

## Direct-Pour Express Dispensers | 1.3-Gallon Jar

- Direct-Pour models are perfect for high-volume house-made sauces and condiments in countertop or drop-in serving applications
- Includes 1.3-gallon, food-safe jar with lid
- Dishwasher-safe, five-piece Express pump makes cleanup a breeze; 1-oz max. portion is adjustable in 1/4-oz increments
- Coordinate with matching Express, pouched-product dispensers for 1 1/2-gallon pouches (See p.13)



	dispenses	model/item	application	description	full portion	dimensions (HxWxD)	weight
d		SE-SS DP 100236		stainless steel base with pump (100239), jar (100280) & lid (100281); countertop	1 oz	17 3/16" x 6 3/8" x 13 1/4"	9 lb
e		SE-SS DI DP 100237		stainless steel base with pump (100239), jar (100280) & lid (100281); drop-in			

SEE TABLE FOR APPLICABLE TRAITS BY MODEL

DISPENSES KEY

- THIN fountain syrups • oils • hot sauce
- THICK ketchup • mustard • mayo • bbq
- THICKER tartar sauce • crafted sauces

APP KEY

- AMBIENT
- COLD
- HOT





# Fountain Jar Pumps

## Stainless Steel Pumps

- Take the guesswork out of serving with portion-control pumps for countertop, drop-in or slanted fountainette applications
- Precise portions control food costs and ensure flavor consistency; portions adjust in 1/8-oz increments
- Drop-in (DI) models have a higher discharge point for additional serving clearance
- Thick Pump (TP) models reduce dispensing force needed when working with especially thick or thicker products; model 80879 with lever assist dispenses thick caramel and fudge with ease
- Coordinate pump knob with store theme or contents within; specify color and text when ordering (see [p.9](#) for details)

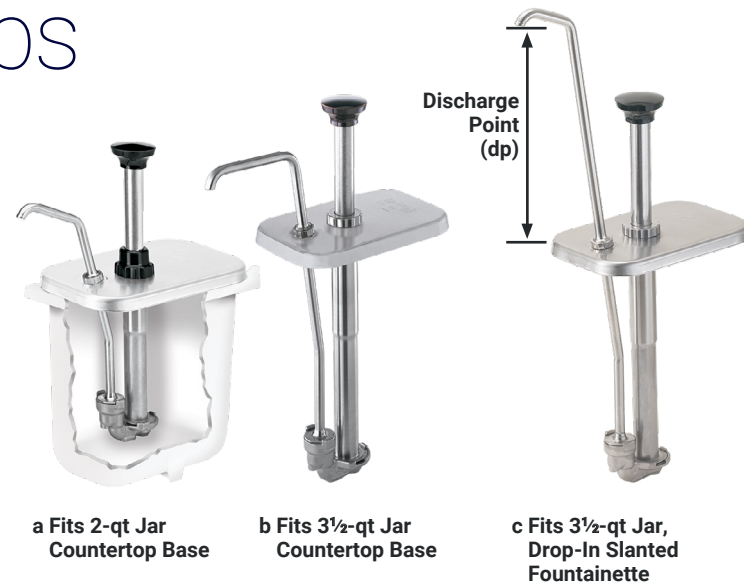

	dispenses	model/item	application	pump & lid fit (jar not incl.)	full portion	4 1/2" W x 7 1/4" D x H above jar	dp	weight
<b>a</b>		FP-200V 82130		2-qt fountain jar (white 82558, black 83147, orange 83148)	1 oz	5 1/8"	2 5/16"	3 lb
		FP-200 82100		(angled discharge)	1 oz	5 1/8"	2 7/8"	
		FP-200 DI 80030		(angled & drop-in use)	1 oz	5 13/16"	5 5/16"	
		CP-200 83300		2-qt fountain jar (white 82558, black 83147, orange 83148)	1 oz	5 1/8"	4 1/8"	3 lb
		TP-200V 86750			1 oz	5 1/8"	2 5/16"	
<b>b</b>		FP-V 82120		3 1/2-qt fountain jar (white 82557, black 83149, orange 83156)	1 1/4 oz	5 1/8"	2 9/16"	3 lb
		FPV-DI 82520		(use DI for drop-in)	1 1/4 oz	9 1/4"	8 1/2"	
		FP Compact 81416			3 1/2-qt fountain jar (compact, angled discharge)	1 oz	5 1/4"	
FP 82070	(angled discharge)	1 1/4 oz	5 1/8"		3"	3 lb		
<b>c</b>		FP-DI 82990		(angled & drop-in use)	1 1/4 oz		9 5/16"	8 3/4"
		CP-F 83330			1 1/4 oz	5 1/8"	4"	
		CP-F 2 oz 87660			3 1/2-qt fountain jar (white 82557, black 83149, orange 83156)	2 oz	6 1/8"	4"
TP-V 86760		1 1/4 oz	5 3/16"		2 9/16"			
<b>d</b>		TPV-L 80879*			1 oz	9 9/16"	2 13/16"	3 lb

\*Support bracket (100001) prevents tipping when used in SR-2, SR-3 or SR-4 bases.

## Leverage your toppings.

Take the pain out of serving thick caramel, fudge and marshmallow creme.

See component guide featured on [p.39](#)

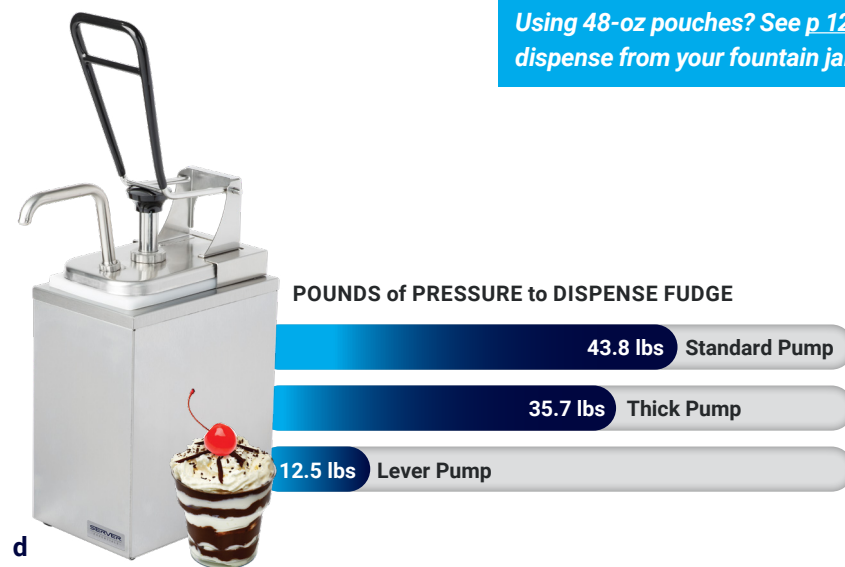

Using 48-oz pouches? See [p.12](#) to dispense from your fountain jar.

## Slim Jar Stainless Steel Pumps

- Slim fountain jars allow you to easily add toppings to your station; (6) slim jars fit in the same space as (4) standard fountain jars
- Slim jar, portion-control pumps take the guesswork out of serving in countertop, drop-in or slanted fountainette applications; portions adjust in 1/8-oz increments
- Drop-in (DI) models have a higher discharge point for additional serving clearance
- Thick Pump (TP) models reduce dispensing force needed when working with especially thick or thicker products
- Pump knob can be colored and engraved (see [p.9](#) for details)
- NSF listed, clean-in-place certified or disassemble for cleaning

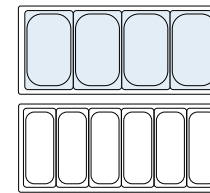

Integrate into existing stations with (3) slim jars for every (2) standard fountain jars. See component guide featured on [p.39](#)

	dispenses	model/item	application	lid only	pump & lid fit (inset not incl.)	full portion	3 1/8" W x 7 1/8" D x H above jar	dp	weight
<b>e</b>		FP-200V Slim 85310		83188	1 1/2-qt slim jar (white 83181, black 83157, orange 83158)	1 oz	5 1/8"	2 5/16"	1 lb
		FP-200 Slim 85350		(angled discharge)	83192				2 7/8"
		FP-V Slim 85300		83187	2-qt slim jar (white 83182, black 83159, orange 83162)	1 1/4 oz	5 1/8"	2 9/16"	2 lb
		CP-F Slim 85340			83195	2-qt slim jar (white 83182, black 83159, orange 83162)	1 1/4 oz	5 1/8"	4 1/16"

SEE TABLE FOR APPLICABLE TRAITS BY MODEL

**DISPENSES KEY**

- THIN fountain syrups • oils • hot sauce
- THICK ketchup • mustard • mayo • bbq
- THICKER tartar sauce • crafted sauces

**APP KEY**

- AMBIENT
- COLD
- HOT

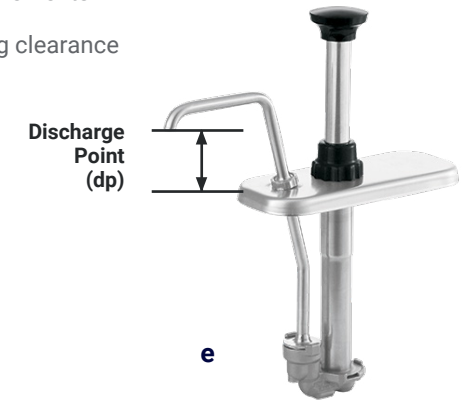

## Fit for flavor.

Slim fountain jars allow you to inexpensively add flavors to your station. To retrofit your existing Server pump to fit slim jars, just replace the lid (noted above).





# Inset Pumps

## Stainless Steel Pumps

- Top entrées with condiments, sauces and gravies from your vegetable insets
- Precise portions control food costs and ensure flavor consistency; 1-oz max portion adjusts in 1/8-oz increments
- Models with 2-oz stroke improve back-of-house efficiency; adjust to serve 1 3/4, 1 1/2 or 1 1/4 oz with included collars
- Coordinate pump knob with store theme or contents within; specify color and text when ordering (see [p.9](#) for details)
- NSF listed, clean-in-place certified or disassemble for cleaning



SEE TABLE FOR APPLICABLE TRAITS BY MODEL

**DISPENSES KEY**

- THIN**  
fountain syrups • oils • hot sauce
- THICK**  
ketchup • mustard • mayo • bbq
- THICKER**  
tartar sauce • crafted sauces

**APP KEY**

- AMBIENT**
- COLD**
- HOT**

	dispenses	model/item	application	pump & lid fit (inset sold separately)	full portion	height (above inset)	weight
<b>a</b>		CP-5 83920		2 1/2 qt, 5" dia. inset (81066)	1 oz	4 3/8"	3 lb
		CP-6-1/2 83200		4 qt, 6 1/2" dia. inset (81031)	1 oz	4 3/8"	3 lb
<b>b</b>		CP-8-1/2 83220		7 qt, 8 1/2" dia. inset (84031) CP-8 1/2 L includes screw to secure lid to inset	1 oz	4 3/8"	3 lb
		CP-8-1/2 L 83910			2 oz	6 1/8"	4 lb
<b>c</b>		CP-8-1/2 2 oz 87620		11 qt, 10 1/2" dia. inset (84131)	1 oz	4 3/8"	4 lb
		CP-10-1/2 83240			2 oz	6 1/8"	4 lb
		CP-10-1/2 2 oz 87680					

# Specialty Dispensers

## Chilled Dispensers

- Dispense cold foods from an insulated vessel with ice packs or HoldCold™ jars
- Precise portions control food costs and ensure flavor consistency; 1-oz max portion adjusts in 1/8-oz increments
- MMS model is popular for tartar or mayo; CSM pump is designed to prevent splashing for non-dairy creamer
- Coordinate pump knob with store theme or contents within; specify color and text when ordering (see [p.9](#) for details)



Cool with (2) ice packs (includes jar)

	dispenses	model/item	application	description	capacity	full portion	dimensions (HxWxD)	weight
		MMS 94070		insulated dispenser with sst jar (94009) & (2) ice packs (100515)	3 qt	1 oz	14 7/8" x 7 3/4" x 10 7/16"	9 lb
		CSM 94000						





# Stations

## Produce more productive.

Get the most out of your serving line and boost back-of-house productivity. Our serving stations keep your condiments, syrups and toppings on hand and organized, so you can craft all kinds of delicious variety in no time, while business keeps flowing smoothly.

**2** YEAR  
WARRANTY

All Server Stations are backed by a two-year warranty.

### Station Selection Guide

25

#### Squeeze Bottle Holders



26

#### Mini Station



32

#### Pouched Food Stations



28

#### Fountain Jar Stations



36

#### Tiered Stations



30

### Mini Station Creation Guide

33

### Station Creation Guide

38

 Visit our online resource

 Consult your rep or find a dealer

 Get in touch

**HOW TO BUY**



# Speed, ease and efficiency – all in one simple station.

From front to back of house, we work to streamline service and simplify day-to-day operations. Our serving stations are designed to keep condiments, syrups, toppings and more in a compact, convenient space. Organize, prioritize and customize all kinds of flavors without wasting time, effort or money.

**MAX EFFICIENCY**

Configure your stations how you want for ultimate speed and service.

**COMPLETELY CUSTOMIZABLE**

Add a pump or two. How about a few jars? Whatever you want. It's yours to customize.

**LTO-SO EASY**

Swapping out new and exciting flavors for limited-time offers has never been so simple.

## Fun assembly required.

We're here to help you put together the perfect station for your operation. Our Station Selection Guide is your step-by-step assistant with all kinds of options and configurations at your service. Simply select what works best and you're on your way to smoother serving.

### SQUEEZE WITH STYLE

Squeeze bottle holders come in drop-in or countertop stations so you can add the finishing touch wherever you need.

### CHILLED OR AMBIENT STATIONS

Veggies, cheese crumbles, garnishes and more – we'll keep it fresh and delicious all day long.

### GARNISH SERVERS

Sliced, chilled and ready to add colorful flavor to your food and beverages.



## LTO, so easy.

Your customers want variety. You want simplicity. Now you get both. Easily switch ingredients and offer today's trending flavors with exciting limited-time offers and customizable drinks and dishes. **Simply assemble your station below and LTO away.**



Container Type	Squeeze Bottles p.26-27	Food Pouches p.28-29	Tiered Servers (bottles, chips, jars) p.30-31	Mini Jars (1/8 & 1/2) p.32-35	Fountain Jars (standard & slim) p.36
<b>Serving Application</b>	Ambient   Cold	Ambient	Ambient	Ambient   Cold	Ambient   Cold
<b>Footprint</b>	Countertop   Drop-In	Countertop   Drop-In	Countertop	Countertop   Drop-In	Countertop   Drop-In (cold only)
<b>Flavor Varieties</b>	2-8	2-5	2-3	2-5	2-6
<b>Serving Method</b>	Squeeze	Pump	Serving Utensil   Pumps	Serving Utensil   Pumps	Serving Utensil   Pumps
<b>Pump Style</b> See Pump Selection Guide for details, p.8		Express Pumps	Eco   SST Pumps	SST Pumps	SST Pumps





# Squeeze Bottle Holders

## Drop-In | Cold

- Organize your cold table with a drop-in squeeze bottle holder
- Keeps bottles up to 10° F colder than holding in pans
- Stainless steel open-frame design allows air to circulate below and the top helps keep cold air from escaping
- FIFO™ and TableCraft® bottles are low-temp, dishwasher safe and BPA free; included with holders

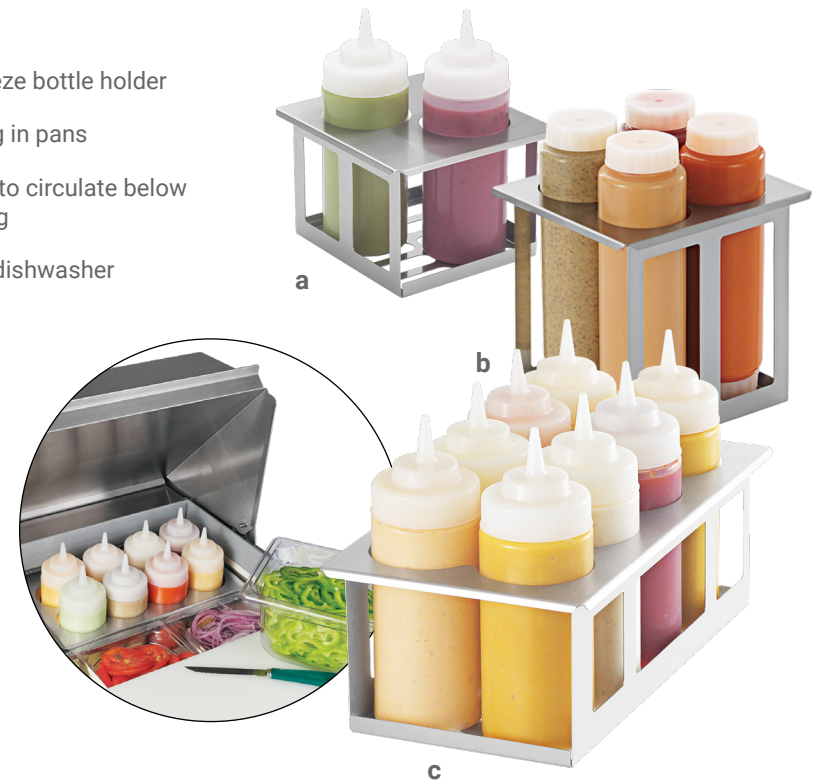

model/item	application	description	capacity (incl.)	dimensions (HxWxD)	weight
a SBH-2 86829			(2) 16-oz TableCraft®	8 1/8" x 7 1/16" x 6 7/16"	2 lb
SBH-3 86831	☞ ❄️	1/6-size holder	(3) 16-oz TableCraft®	8 1/8" x 7 1/16" x 6 7/16"	2 lb
b SBH-4 86994			(4) 16-oz FIFO™	8 9/16" x 6 7/16" x 7"	3 lb
SBH-6 87045	☞ ❄️	1/3-size holder	(6) 16-oz TableCraft®	9 9/16" x 12 7/8" x 6 7/8"	3 lb
c SBH-8 86974	☞ ❄️	1/3-size holder	(8) 16-oz TableCraft®	8 1/8" x 13 1/16" x 7 1/16"	4 lb
SBH-8 86996	☞ ❄️	1/3-size holder	(8) 16-oz FIFO™	8 9/16" x 12 7/8" x 7"	4 lb
d SBH-3 87530	☞ 🔥	1/6-size holder	(3) 16-oz High-Density	5 7/8" x 6 1/2" x 7 1/8"	2 lb

NOTE: FIFO™ & TableCraft® bottles are trademarks of their respective owners.

## Drop-In | Warm

- Ideal for low-temperature warming of finishing sauces and dessert drizzle
- Stainless steel open-frame design allows warm air to circulate below
- Includes three 16-oz high-density squeeze bottles (86809)



Shown in heated 1/3-pan warmer IS-1/3 86090

## Countertop Stations

We've combined a few squeeze bottle holders with a countertop piece to put dressings where you need them, such as a finishing station.



Ice packs make changeouts quick & easy – order an extra set to swap out every 4 hours.

Includes 100515 ice packs

model/item	application	description	capacity (incl.)	dimensions (HxWxD)	weight
e 87340	☞ ❄️	(8) bottle mini station	(8) 16-oz TableCraft® & (4) ice packs	11 13/16" x 14 1/8" x 8 9/16"	11 lb
f 87360	☞ ❄️	(8) bottle mini station	(8) 16-oz FIFO™ & (4) ice packs	11 13/16" x 14 1/8" x 8 9/16"	11 lb





# Pouched Food Stations | Express

Flexible packaging is ideal for delivering high volumes of condiments in fast-paced, institutional and quick-serve environments. The bag fitment connects directly to the dispenser for an operator-friendly system that streamlines workflow so you can serve better, faster. Express dispensers and NEW stations serve 2-6 flavors in countertop and drop-in applications.

**ADA compliant** | Less than 5 lbs of pressure to dispense

**OPERATOR FRIENDLY**  
Durable plastic pumps have fewer parts for less fuss

Work exclusively with 1½- or ¾-gallon pouches with a 16-mm fitment

**HIGH YIELD**  
Up to 98% product evacuation means more portions served and less waste

**CUT COSTS**  
Serving from pouches rather than portion packets yields big savings

**PEACE OF MIND**  
Closed-loop systems protect from cross-contamination risks

**MORE RESPONSIBLE**  
Pouches produce 97% less solid waste than rigid containers

Click for toppings & dressings available by food manufacturers



## Express Dispensing

## Express Stations | 1½ Gallon

- Simplify condiment management – Express Systems dispense from 1½-gallon pouches with a 16-mm fitment, forming a sealed, sanitary system
- Durable, plastic pumps (07794) have fewer parts for easier use; dispense 1-oz portion, reduce in ¼-oz increments
- Up to 98% evacuation means more portions served and less waste

**NSF** **ADA compliant** | Less than 5 lbs of pressure to dispense

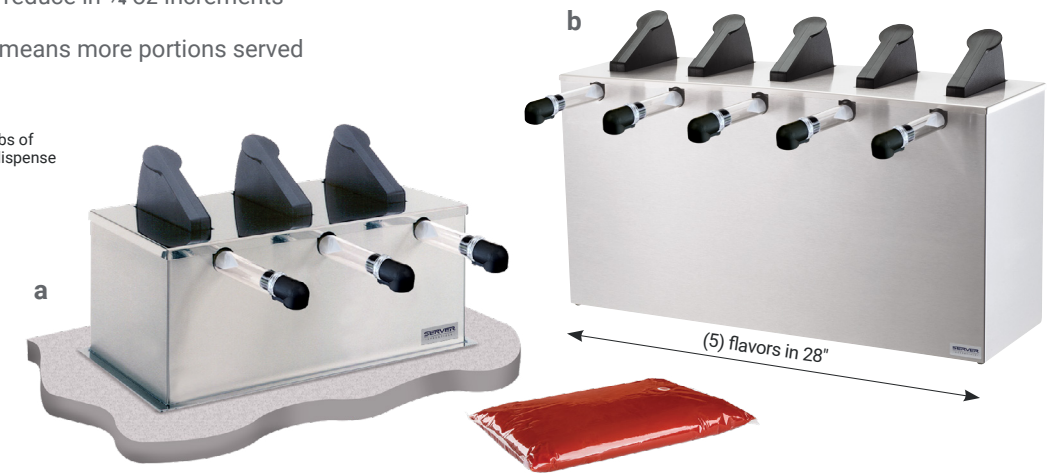

	dispenses	model/item	application	description	capacity	dimensions (HxWxD)	weight
		SE-2.07140		(2) 07794 pumps, countertop	(2) 1½ gal, 16 mm	17½" x 11" x 13 5/16"	12 lb
		SE-3.07040		(3) 07794 pumps, countertop	(3) 1½ gal, 16 mm	17½" x 16 5/8" x 13 5/16"	18 lb
a		SE-3DI.07050		(3) 07794 pumps, drop-in (DI)	(3) 1½ gal, 16 mm	10 7/16" x 17 1/4" x 13 5/4"	
		SE-4.07200		(4) 07794 pumps, countertop	(4) 1½ gal, 16 mm	17½" x 21 18/16" x 13 5/16"	23 lb
b		SE-5.07060		(5) 07794 pumps, countertop	(5) 1½ gal, 16 mm	17½" x 27 5/16" x 13 5/16"	27 lb

SEE TABLE FOR APPLICABLE TRAITS BY MODEL

**DISPENSES KEY**

- THIN**  
fountain syrups • oils • hot sauce
- THICK**  
ketchup • mustard • mayo • bbq
- THICKER**  
tartar sauce • crafted sauces

**APP KEY**

- AMBIENT**
- COLD**
- HOT**





# Tiered Stations

## WireWise® Organizers

- Attractive wire frame design is lightweight yet durable and includes (4) non-skid feet
- Eco Pumps™ shown are sold separately (featured on [p.11](#)); jars and stainless steel pumps are also sold separately (featured on [p.20](#))



Tiered racks  
for your common  
food containers  
save space

	model/item	application	description	holds/capacity	dimensions (HxWxD)	weight
a	<a href="#">WW-3_64 oz 88656</a>		64-oz square jug organizer	(3) 64 oz	15 7/16" x 5 1/8" x 16 1/2"	4 lb
b	<a href="#">WW-3_1L 88652</a>		bottle organizer up to 1 L	(3) 1 L	15 3/4" x 4 7/16" x 12 5/16"	4 lb
c	<a href="#">WW-3_1 gal 88654</a>		1-gal jug organizer	(3) 1 gal	16 1/2" x 6 3/8" x 19 3/4"	5 lb

## WireWise® Stations

- Maximize counter space in guest and operator areas
- Tiered station with 1/2-size jars includes:
  - > WireWise™ organizer, 1/2-size jar openings
  - > (3) 87202 1/2-size, 41-oz jars in black
  - > (3) 87253 1/2-size, clear hinged lids
  - > (3) 85156 clear 1/2-oz serving spoons



Stations  
are complete  
with all you  
need to serve

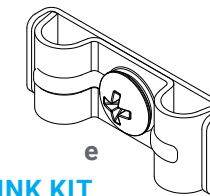

**LINK KIT**  
Clips two organizers  
together to form one.

	model/item	application	description	capacity (incl.)	dimensions (HxWxD)	weight
d	<a href="#">WW-3 1/2 88711</a>		WireWise™ Station w/ jars, lids & spoons	(3) 41 oz	12 1/2" x 4" x 22 1/8"	5 lb
e	<a href="#">88716</a>		WireWise™ Link Kit, 4 pk	NA	NA	NA

Polycarbonate spoons contain BPA

SEE TABLE FOR APPLICABLE TRAITS BY MODEL

**DISPENSES KEY**

- THIN**  
fountain syrups • oils • hot sauce
- THICK**  
ketchup • mustard • mayo • bbq
- THICKER**  
tartar sauce • crafted sauces

**APP KEY**

- AMBIENT**
- COLD**
- HOT**







# Mini Station

## Mini Station with Spoons

- Built around exclusive 1/9-size jars, Mini Stations pack a lot in a small footprint, while displaying your fresh toppings safely under a clear hinged lid
- Insulated to hold cold food with ice packs, so those chocolate chips don't stick together in warm wait stations or outdoor breakfast bars
- Provide up to (4) hours of cold food holding with (2) universal ice packs or ice
- Station include an insulated stainless steel base, plus:
  - (4) 87203 1/9-size, black jars with 60-oz capacity
  - (4) 87253 clear hinged lids
  - (4) 85156 clear 1/2-oz serving spoons



**Ice packs make changeouts quick & easy – order an extra set to swap out every 4 hours.**

100515 ice packs sold separately

# Mini Station Creation

## Mini Station Creation: Easy as 1-2-3

### 1-2-3 Select base for toppings

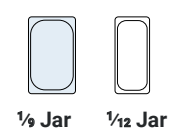

Toppings Served = Base & Jar Options

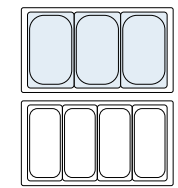

3 or 4 Toppings  
Countertop, 7"

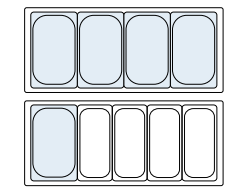

4 or 5 Toppings  
MB-3 87280  
MB-4 87460

Brushed stainless steel with insulated black interior helps reduce the visibility of fingerprints for a clean appearance.

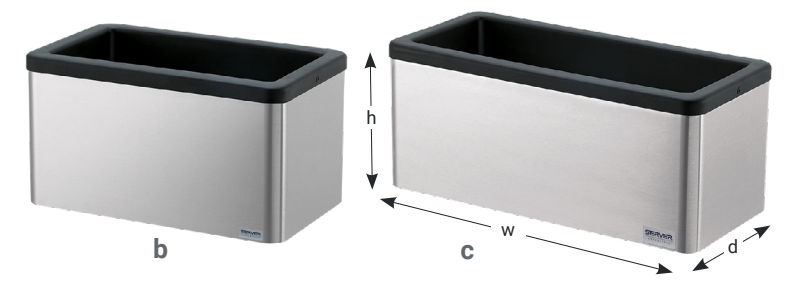

### Mini Station Bases

model/item	application	description	base capacity	dimensions (HxWxD)	weight
b MB-3 87280		* 3-jar 7" base, countertop	(3) 60-oz 1/9 jars or (4) 40-oz 1/12 jars & (2) ice packs 100515	7 15/16" x 14 1/8" x 8 3/8"	6 lb
c MB-4 87460		* 4-jar 7" base, countertop	(4) 60-oz 1/9 jars or (1) 60-oz 1/9 & (4) 40-oz 1/12 jars & (2) ice packs 100515	7 15/16" x 18 3/16" x 8 3/8"	7 lb

\*Jar number in model and description is based on 1/9-size jars

model/item	application	ice packs accepted	description	capacity	dimensions (HxWxD)	weight
a MB-4 87480		(2)	(4) jar, lid & spoon station	(4) 1/9 jars, 60 oz	9 7/16" x 18 1/16" x 8 1/4"	9 lb

Polycarbonate spoons contain BPA



1/2

of consumers would be extremely/very interested in using more nuts/seeds as a protein source.

HealthFocus USA Study, 2021



# Mini Station Creation

## 1-2-3 Choose jars to fit base capacity

Plastic jars are made of high-impact polypropylene for years of use. Design features include a notch for the ladle handle to allow the lid to close completely, rear tab holes for stainless steel hinged lids to attach to the jar and side slots for securing clear hinged lids.

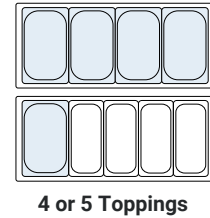
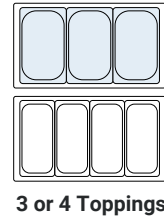
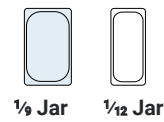

### Mini Station Jars

jar color	item	description	capacity	overall dimensions (HxWxD)
a	87203	1/8-size jar, 6"	60 oz	6 19/32" x 4 1/32" x 6 7/8"
	87195			
	87202	1/8-size jar, 3 1/2"	41 oz	4 1/32" x 4 1/32" x 6 7/8"
	87194			
b	87925	1/12-size jar, 3 1/2"	24 oz	4 1/32" x 3 1/16" x 6 7/8"



## 1-2-3 Choose lids and serving utensils or pumps

### Mini Station Accessories

item	jar size	description
87253	1/8	center-hinged lid, clear <b>a</b>
81414	1/8	SST hinged lid, disher opening <b>c</b>
87211	1/8	SST hinged lid <b>d</b>
87234	1/8	strike bar, portion level <b>e</b>
87213	1/8	SST steel ladle, 6" handle, 1 oz <b>f</b>
82717	1/8	SST steel ladle, 4" handle, 1 oz <b>f</b>
87923	1/12	center-hinged lid, clear <b>g</b>
85156	1/8, 1/12	clear, polycarbonate spoon, 1/2 oz <b>h</b>
100515		universal ice pack <b>i</b>

Polycarbonate spoon contains BPA



Keep cold up to 4 hours; use one, freeze one



## 1-2-3 Choose pumps

Consistently serve with precise portion control in 1/8-oz increments

See p.16 for additional details



dispenses	model/item	application	pump & lid fit (jar not incl.)	full portion	dim. above pan (HxWxD)	weight
	FP-1/8 87310		1/8-size jar, 60 oz (87203 black, 87195 orange)	1 oz	5 19/16" x 3 19/16" x 6 1/4"	2 lb
	CP-1/8 87300					

SEE TABLE FOR APPLICABLE TRAITS BY MODEL

DISPENSES KEY

- THIN fountain syrups • oils • hot sauce
- THICK ketchup • mustard • mayo • bbq
- THICKER tartar sauce • crafted sauces

APP KEY

- AMBIENT
- COLD
- HOT

## Inspirational Examples

### 1/12-Jar Dessert Topping Station

item	description
(1) MB-3 87280	3-jar, 7" base, countertop
(4) 87925	1/12-size jar, black, 3 1/2", 24 oz
(4) 87923	1/12-size, center-hinged lid, clear
(4) 85156	clear spoon, 7" handle, 1/2 oz
(4) 100515	ice packs, use 2 freeze 2



### 1/8-Jar Burger Topping Station

item	description
(1) MB-4 87460	4-jar, 7" base, countertop
(4) 87203	1/8-size jar, 6", 60 oz
(2) CP-1/8 87300	1/8-size jar condiment pumps**
(2) 87211	1/8-size SST hinged lid
(2) 87213	SST ladle, 6" handle, 1 oz
(6) 100515	ice packs, use 3 freeze 3



We're here to help — let's chat at [server-products.com](http://server-products.com), 800.558.8722 or [spsales@server-products.com](mailto:spsales@server-products.com).

## Interchangeable Engraved and Colored Knobs

Help staff and patrons identify contents, coordinate with store themes or promote branded products. Specify color\* and text at time of order. See p.9 for color options.

\*Exact shade may vary from picture  
\*\*Specify red and yellow knobs when ordering





# Fountain Jar Stations

## Stainless Steel Pump Stations | Cold

- Ideal for dispensing high-demand condiments and dressings in countertop or drop-in (DI) applications
- Precise portions control food costs and ensure flavor consistency; pumps serve 1¼ oz max, adjust in ⅛-oz increments
- Insulated stainless steel base keeps food cold up to (4) hours between changeouts with ice packs or ice
- Stations include an insulated base, plus:
  - > (2, 3 or 4) 82557 white fountain jars, 3½ qt
  - > (2, 3 or 4) 83330 SST pumps for thick products
 See our Pump Selection Guide before choosing; [p. 8](#)



Ice packs make changeouts quick & easy – order (1) 100515 ice pack (sold separately) per jar.



SEE TABLE FOR APPLICABLE TRAITS BY MODEL

**DISPENSES KEY**

- THIN**  
fountain syrups • oils • hot sauce
- THICK**  
ketchup • mustard • mayo • bbq
- THICKER**  
tartar sauce • crafted sauces

**APP KEY**

- AMBIENT**
- COLD**
- HOT**

	dispenses	model/item	application	description	capacity	full portion	dimensions (HxWxD)	weight
a		SB-3 83790		(3) jars & pumps, countertop	(3) fountain jars, 3 ½ qt	1 ¼ oz	19 3/8" x 15 1/2" x 8 13/16"	21 lb
		SB-3 DI 83860		(3) jars & pumps, drop-in (DI)				
b		SB-4 83700		(4) jars & pumps, countertop	(4) fountain jars, 3 ½ qt	1 ¼ oz	19 3/8" x 20 1/8" x 8 13/16"	27 lb
		SB-4 DI 83720		(4) jars & pumps, drop-in (DI)				

## Stainless Steel Pump Stations

- Manage serving size of syrups and sauces with stainless steel portion-control pumps; 1¼ oz max, adjust in ⅛-oz increments
- Brushed stainless steel base helps reduce the visibility of fingerprints for a clean appearance; non-insulated
- Coordinate pump knob with store theme or contents within; specify color and text when ordering; black is standard (see [p. 9](#) for details)
- Stations include non-insulated, countertop base plus:
  - > (2, 3 or 4) 82557 white fountain jars, 3½ qt
  - > (2, 3 or 4) 82120 SST pumps for thin products
 See our Pump Selection Guide before choosing; [p. 8](#)



	dispenses	model/item	application	description	capacity	full portion	dimensions (HxWxD)	weight
c		SR-2 82910		(2) jars & st st pump station	(2) jars, 3 ½ qt	1 ¼ oz	16 1/16" x 10 7/8" x 8 13/16"	13 lb
		SR-3 82870		(3) jars & st st pump station	(3) jars, 3 ½ qt	1 ¼ oz	16 1/16" x 15 1/2" x 8 13/16"	18 lb
d		SR-4 82830		(4) jars & st st pump station	(4) jars, 3 ½ qt	1 ¼ oz	16 1/16" x 20 1/8" x 8 13/16"	22 lb





# Station Creation Guide

## 1-2-3-4 Select base for toppings

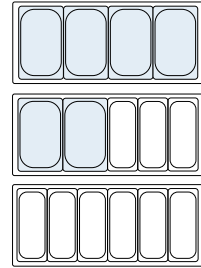
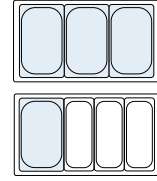
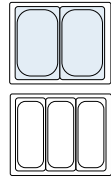
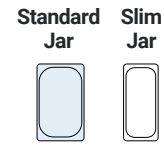

### Toppings Served = Base & Jar Options

	1 Topping	2 or 3 Toppings	3 or 4 Toppings	4, 5 or 6 Toppings
Countertop Non-Insulated	<b>a</b> SR-1 84090	<b>c</b> SR-2 82570	SR-3 82600	<b>e</b> SR-4 82550
Countertop Insulated	<b>b</b> SB-1 87510	SB-2 80160	<b>d</b> SB-3 83760	SB-4 83600
Drop-In Insulated			SB-3DI 83830	SB-4DI 83620



### Station Bases

model/item	application	description	base capacity	dimensions (HxWxD)	weight
<b>a</b> SR-1 84090	☞	*1-jar base, countertop	(1) fountain jar	10" x 5 1/2" x 8"	4 lb
<b>b</b> SB-1 87510	☞ ☞	*1-jar base, countertop	(1) fountain jar (1) ice pack**	12 5/16" x 6 1/16" x 9 1/8"	5 lb
<b>c</b> SR-2 82570	☞	*2-jar base, countertop	(2 or 3) fountain jars	10" x 10 7/8" x 8 19/16"	5 lb
SB-2 80160	☞ ☞	*2-jar base, countertop	(2 or 3) jars & (2) ice packs 100515	12 5/16" x 10 7/8" x 8 19/16"	8 lb
SR-3 82600	☞	*3-jar base, countertop	(3 or 4) fountain jars	10" x 15 1/2" x 8 19/16"	7 lb
<b>d</b> SB-3 83760	☞ ☞	*3-jar base, countertop	(3 or 4) jars & (3) ice packs 100515	12 5/16" x 15 1/2" x 8 19/16"	11 lb
SB-3DI 83830	☞ ☞	*3-jar base, drop-in (DI)	(3) ice packs 100515	cutout dim: 15 5/8" x 8 7/8"	
<b>e</b> SR-4 82550	☞	*4-jar base, countertop	(4, 5 or 6) fountain jars	10" x 20 1/8" x 8 19/16"	8 lb
SB-4 83600	☞ ☞	*4-jar base, countertop	(4, 5 or 6) jars & (4) ice packs 100515	12 5/16" x 20 1/8" x 8 19/16"	12 lb
SB-4DI 83620	☞ ☞	*4-jar base, drop-in (DI)	(4) ice packs 100515	cutout dim: 20 1/4" x 8 7/8"	14 lb

\*Jar number in model and description is based on standard fountain jars.  
\*\* Use ice or (1) generic ice pack with a maximum dimension of 6" x 4" x 1".



## 1-2-3-4 Choose jars to fit base capacity

### How many jars?

Refer to base capacity (left, p.38) for jar types. Slim jars allow you to serve more flavors without taking up additional counter space.

### Fountain Jars

jar color	item	description	outline	capacity	dimensions (HxWxD)
<b>f</b> □	82557	standard, deep fountain jar		3 1/2 qt	10" x 4 9/16" x 7 1/2"
■	83149				
■	83156				
□	82558	standard, shallow fountain jar		2 qt	7 1/2" x 4 9/16" x 7 1/2"
■	83147				
■	83148				
<b>h</b> □	83182	slim, deep fountain jar		2 qt	10" x 3 1/16" x 7 1/2"
■	83159				
■	83162				
□	83181	slim, shallow fountain jar		1 1/2 qt	7 1/2" x 3 1/16" x 7 1/2"
■	83157				
<b>i</b> ■	83158				

Server fountain jars are made of high-impact polypropylene. Note jar size and type for pump or ladle selection - p.40.



Orange jars call out potential allergens





# Station Creation Guide

## 1-2-3-4 Select pumps and/or ladles

### Pumps

- Consistently serve with portion-controlled, stainless steel pumps; adjustable in 1/8-oz increments
- Designed with food types in mind – use the Dispenses Key to narrow your search
- Thick Pump (TP) models reduce dispensing force needed for especially thick or crafted sauces

SEE TABLE FOR APPLICABLE TRAITS BY MODEL

**DISPENSES KEY**

- THIN**  
fountain syrups • oils • hot sauce
- THICK**  
ketchup • mustard • mayo • bbq
- THICKER**  
tartar sauce • crafted sauces

**APP KEY**

- AMBIENT**
- COLD**
- HOT**

base type	dispenses	model/item	pump & lid fit (jar not incl.)	full portion
Countertop	THIN, THICK	CP-200 83300	shallow fountain jar, 2 qt	1 oz
	THIN	FP-200V 82130		
	THIN, THICK	TP-200V 86750		
Countertop	THIN	CP-F 83330	deep fountain jar, 3 1/2 qt	1 1/4 oz
	THIN	FP-V 82120		
	THIN, THICK	TP-V 86760		
	THIN, THICK	TVP-L 80879*		
Drop-In	THIN	FPV-DI 82520	deep fountain jar, 3 1/2 qt	1 1/4 oz
Countertop	THIN	FP-200V Slim 85310	slim shallow fountain jar, 1 1/2 qt	1 oz
Countertop	THIN, THICK	CP-F Slim 85340	slim deep fountain jar, 2 qt	1 1/4 oz
	THIN	FP-V Slim 85300		

Dispensing large portions or using a slanted fountainette? See p.18-19.  
\*Support bracket (100001) prevents tipping when used in SR-2, SR-3 or SR-4 bases.

### Ladles

- Perfect for serving dry or difficult-to-pump ingredients
- Stainless steel construction with a 1-oz capacity

item	description
e 82561	fountain jar ladle, 10" handle, 1 oz
82562	fountain jar ladle, 7" handle, 1 oz
f 82976	slim fountain jar ladle, 10" handle, 1 oz
82977	slim fountain jar ladle, 7" handle, 1 oz



Be sure to select the correct pump for your jar – pumps for shallow jars have a shorter cylinder than those for deep jars



CP models (b) have unformed tube ends, whereas FP models (c) have formed ends to hold back thin product drips

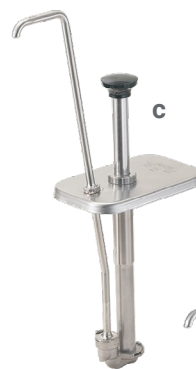

DI models have a 3-inch-taller spout for additional serving clearance



Request knob color and engraving for easy product identification; black is standard. See p.9 for color options.



## 1-2-3-4 Select lids and other accessories

### Lids & Accessories

item	description	jar style
g 80310	clear plastic hinged lid	standard
h 82559	stainless steel lift-off lid	
i 82545	stainless steel hinged lid	
j 81415	stainless steel disher lid	
k 80443	stainless steel lid lock	slim
l 83214	clear plastic hinged lid	
m 83189	stainless steel lift-off lid	
n 83184	stainless steel hinged lid	either
o 100515	universal ice pack	



Use ice packs with an insulated base to keep product cool for up to 4 hours



### Inspirational Examples



#### FroYo Topping Station

item	description
(1) SR-4 82550	non-insulated base (holds 6 slim jars)
(6) 83182	slim fountain jars, 2 qt
(2) FP-V 85300	syrup pumps, slim
(4) 83214	clear hinged lids
(4) 82976	(deep jar) ladles



We're here to help – let's chat at [server-products.com](http://server-products.com), 800.558.8722 or [spsales@server-products.com](mailto:spsales@server-products.com).



#### Condiment Station comes complete with:

item	description
(1) SR-4 82550	non-insulated base (holds 4 standard, deep fountain jars)
(4) 83149	standard, deep fountain jars, 3 1/2 qt
(4) CP-F-83330	fountain jar pumps, deep



# Warmers

Hot and fresh, day and night.

Maintain precise temperature without lifting a finger, even as product is depleted. Server Warmers reduce waste, maintain quality and save money – all while heating and serving fresh, delicious food all day long.

**2** YEAR WARRANTY

All Server warmers are backed by a two-year warranty.

**FLAVOR SAVER**

Thermostats maintain temperature to ensure best flavor, first serving to last.

**RE THERMALIZATION**

NSF listed rethermalizers ensure food is quickly & safely heated to 165°F.

**RESPONSIBLY SERVED**

Pouches serve up to 98% product evacuation from 97% less packaging.

Soup Warmers

**44**

Specialty Warmers

**52**

Topping Warmers

**46**

*"I am very familiar with the brand. I've always used them for warm toppings. They are **versatile, easy to clean** and have a **long life.**"*

Chandon Clenard  
Senior Director of Foodservice  
Guckenheimer - 400 B&I  
locations in 34 states

- [Visit our online resource](#)
- [Consult your rep or find a dealer](#)
- [Get in touch](#)

**HOW TO BUY**



# Soup Warmers

## Single Inset

- Stainless steel water-bath warmers with 5-, 7- or 11-quart inset
- NSF listed rethermalizers – quickly heat soups, proteins and other foods to safe serving temperature
- Eliminate wasted servings with precise temperature control and accurate, even heat
- Hinged lid returns condensation to the food to retain flavor and quality; side handles on larger lids open ergonomically – no reaching over steam



	model/item	description	capacity	dimensions (HxWxD)	plug	voltage	watts	weight
a	FS-4 Plus 81000	warmer with single inset & hinged lid (81111)	5 qt	14 7/8" x 7 3/4" x 8 1/2"	5-15P	120 AC	500	9 lb
b	FS-7 84000	warmer with single inset & hinged lid (84040)	7 qt	14 9/16" x 9 9/16" x 11"	5-15P	120 AC	1000	13 lb
c	FS-11 84100	warmer with single inset & hinged lid (84149)	11 qt	14 1/4" x 11 9/16" x 13"	5-15P	120 AC	1500	15 lb



## Delicious precision.

Keep your soup at the perfect temperature all day long with precise, temperature-sensing thermostats and moisture-capturing hinged lids.

# Twin & Triple Inset

- Stainless steel water-bath warmers with 5-quart insets and hinged lids
- NSF listed rethermalizers – quickly heat to safe serving temperature
- From creamy potato to chicken tortilla, individual thermostat controls keep each food at its proper temperature to eliminate wasted servings
- Maintain quality and keep counters clean; hinged lid returns condensation to the food



	model/item	description	capacity	dimensions (HxWxD)	plug	voltage	watts	weight
d	Twin FS-4 Plus 81200	twin warmer with insets & hinged lids (81111)	(2) 5 qt	14 1/2" x 17" x 9 5/8"	5-15P	120 AC	1000	19 lb
e	Triple FS-4 Plus 85900	triple warmer with insets & hinged lids (81111)	(3) 5 qt	14 1/2" x 25 1/2" x 9 5/8"	5-15P	120 AC	1500	28 lb



Heat up your soup program with custom graphics. Download templates now at [server-products.com](http://server-products.com)



# Topping Warmers

## Single Warmers

- Water-bath models available for serving sweet and savory toppings with a pump (FSP), ladle (FS) or squeeze bottles (SBW)
- Precise temperature control and even heat reduce wasted servings
- Pump or ladle from #10 can or stainless steel jar (accessory - 94009)
- Adaptable base is interchangeable with all three serving methods



	model/item	description	capacity	dimensions (HxWxD)	plug	voltage	watts	weight
<b>a</b>	<a href="#">FSP 82060</a>	warmer with topping pump (81320)	3 qt	15 3/4" x 7 3/4" x 13 1/2"	5-15P	120 AC		9 lb
	<a href="#">FSP 82110</a>	warmer with topping pump (81320) & stainless steel jar (94009)	2.8 L	40 x 19.7 x 33.2 cm	Euro		500	4.5 kg
	<a href="#">FSP 84580</a>				UK			
<b>b</b>	<a href="#">FS 82500</a>	warmer with ladle (82561), lid (82509) & adapter (82507)	3 qt	12 3/4" x 7 3/4" x 8 1/2"	5-15P	120 AC	500	8 lb
<b>c</b>	<a href="#">SBW 86810</a>	SignatureTouch™ squeeze bottle warmer with (3) high-density squeeze bottles (86809) & bottle inset (86811)	(3) 16 oz	12" x 7 3/4" x 8 1/2"	5-15P	120 AC		9 lb
	<a href="#">SBW 86925</a>		(3) .47 L	30.5 x 19.7 x 21.6 cm	UK	230 AC	500	3.6 kg



## Twin Warmers

- Water-bath twin base with independent heat control serves toppings with pumps, ladles or one of each from #10 cans or stainless steel jars (accessory - 94009)
- Pumps provide consistent servings while managing food costs; 1 oz per stroke; adjust in 1/8-oz increments
- Adaptable base accepts (3) 16-oz high-density squeeze bottles (86809) and bottle inset (86811)



	model/item	description	capacity	dimensions (HxWxD)	plug	voltage	watts	weight
<b>d</b>	<a href="#">Twin FSP 81230</a>	warmer with (2) pumps (81320)	(2) 3 qt	15 3/4" x 17" x 13 1/2"	5-15P	120 AC		18 lb
	<a href="#">Twin FSP 81260</a>	warmer with (2) pumps (81320) & stainless steel jars (94009)	(2) 2.8 L	38.9 x 43.2 x 34.3 cm	Euro	230 AC	1000	9.1 kg
	<a href="#">Twin FSP 84990</a>				UK			
<b>e</b>	<a href="#">Twin FS 81220</a>	warmer with (2) ladles, lids & adapters	(2) 3 qt	12 3/4" x 17" x 13 1/2"	5-15P	120 AC	1000	17 lb
<b>f</b>	<a href="#">Twin FS/FSP 81290</a>	warmer with pump & ladle	(2) 3 qt	15 3/4" x 17" x 13 1/2"	5-15P	120 AC	1000	17 lb



## Convert for good.

Better for your budget and the environment – our simple pouch solutions keep up with today's packaging evolution. You can still switch to the pouch with your current FSP warmer; no need to buy new.

- Purchase a reusable stainless steel jar (94009) and pour pouched toppings in
- If pouches have a fitment, purchase a pouch conversion kit (81184) to retrofit your pump – see how at [Can2Pouch.com](http://Can2Pouch.com).



## Sweet savings with Portion Optimization.™

Reducing your serving size by as little as 1/8 oz can create significant savings without sacrificing flavor.

If you change portions from 1 oz to 7/8 oz.

**That's like getting every eighth can for free!**



# Topping Warmers

## Protect Your Product

Each water-bath topping warmer includes a plastic spacer. This spacer is critical to ensure the proper operation of your warmer when serving from a #10 can or 3-quart stainless steel jar (94009).

The spacer keeps the can/jar properly positioned, providing multiple benefits:

- Allows the water-bath warmer to evenly heat all sides of the food can/jar, rather than direct contact to the bottom only
- Prevents water overflow into the product, safeguarding quality and integrity
- Ensures more product is dispensed and served to customers; without a spacer, excess product is left in the can and remains unused



## Single Merchandisers

- Ideal for theaters, stadiums, fairs and snack food operators – heated spout ensures safety when dispensing potentially hazardous foods
- Warm and serve caramel, hot fudge and cheese sauce from a #10 can, 3-quart jar accessory or 48-ounce pouch with fitment
- Butter model pump is designed to prevent splashing and serves from a 3-quart stainless steel jar (included)
- Eliminate waste with precise temperature control and accurate, even heat
- Pump provides consistent servings while managing food costs; 1 oz per stroke; adjusts in 1/8-oz increments
- Reduce waste and speed cleanup – serve from a 48-ounce pouch with the new pouched dispensing model



Includes magnetic decals shown. Make it yours – download templates at [server-products.com](http://server-products.com) for custom graphics

	model/item	description	capacity	dimensions (HxWxD)	plug	voltage	watts	weight
<b>a</b>	<a href="#">FSPW-SS 81140</a>	warmer with pump (81320)	3-qt jar	15 7/16" x 8 15/16" x 15 1/2"	5-15P	120 AC		15 lb
<b>b</b>	<a href="#">FSPW-SS 100066</a>	pouch warmer with piercing pump (81185)	48-oz pouch w/ fitment	15 7/16" x 8 15/16" x 15 1/2"	5-15P	120 AC	517	19 lb
	<a href="#">FSPW-SS 80840</a>	warmer with pump (81320)	2.8 L jar	39.2 x 22.7 x 39.4 cm	Euro	230 AC		7.3 kg
	<a href="#">FSPW-SS 83697</a>	& stainless steel jar (94009)			UK			
<b>c</b>	<a href="#">BSW-SS 86540</a>	warmer with butter pump (06110) & stainless steel jar (94009)	3-qt jar	13" x 8 15/16" x 15 1/2"	5-15P	120 AC	517	16 lb

Contact your food distributor for 48-oz topping pouches with a 16-mm center fitment featured on [p. 50](#).





# Topping Warmers

## EZ-Topper® Pouched Product Merchandisers

- A sealed, contaminant-free system is created when the pump pierces a pouch with fitment
- Evacuation is excellent; more servings to your patrons means more profit
- Cleanliness – pump exterior and food vessel remain clean because topping is contained in the pouch
- No water-level monitoring or risk of vapor damage to topping
- Pouches occupy less storage space and produce less waste than rigid packaging, helping the environment and reducing operator costs

SEE IT IN ACTION AT [EZ-TOPPER.COM](http://EZ-TOPPER.COM)

Back



EZ-Topper® units use specialized pouched toppings. Contact your food distributor for 48-oz topping pouches with a 16-mm center fitment; currently packaged by:

- Ghirardelli Chocolate Company
- The Hershey Company
- Lyons Magnus
- Masterson Company



48-oz Pouch  
16-mm center fitment

Radiant heat from the vessel warms the heater block to keep toppings warm during slow periods.

Up to 98% product evacuation & 97% less packaging waste with pouches.

Pouch and fitment create sealed, sanitary system without the mess.

Dispense from one pouch while pre-heating a second in reserve (shown without reserve pouch); low-profile models eliminate space for pre-heating.



pouch perfection

Front cutaway

## Single & Twin Merchandisers

- To keep topping at its peak flavor and texture, pouched product is heated with temperature-sensing thermostats, without the need for a water bath
- Manage serving sizes of expensive ingredients with the portion-controlled, stainless steel pump; 1-oz max portion; adjusts in 1/8-oz increments

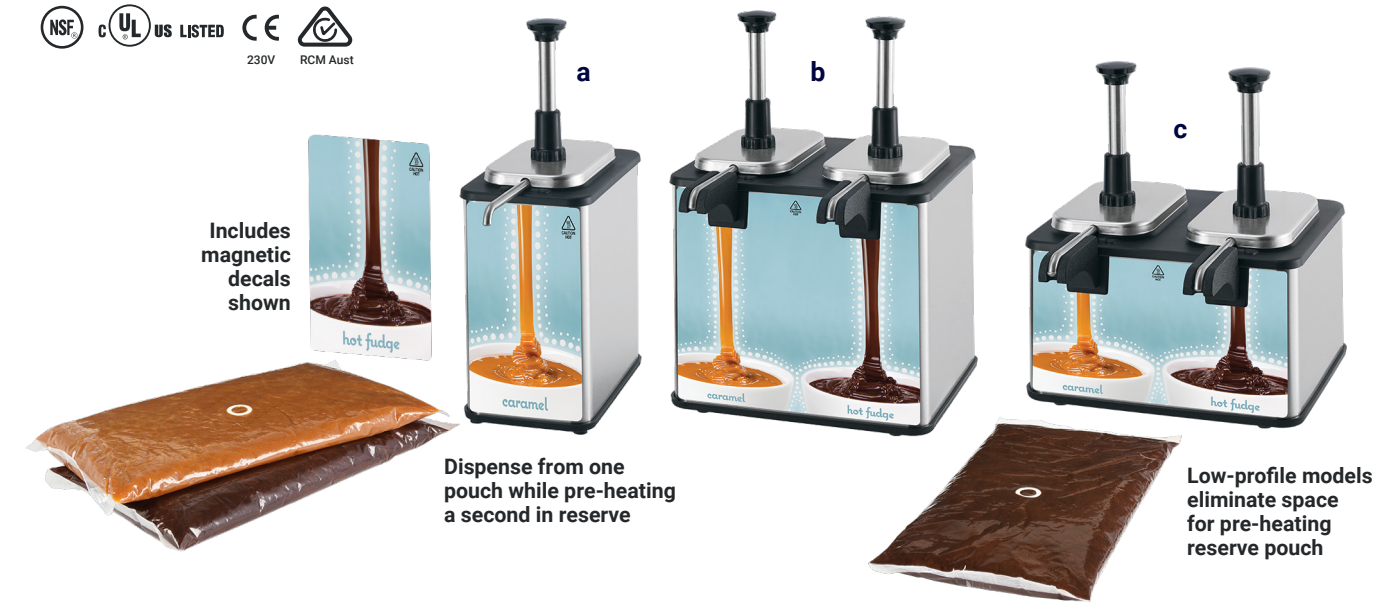

Dispense from one pouch while pre-heating a second in reserve

Low-profile models eliminate space for pre-heating reserve pouch

	model/item	description	capacity	dimensions (HxWxD)	plug	voltage	watts	weight
a	EZT-S.85790	Single (1) pump (85820) base warms spout & (2) pouches	(2) 48 oz	17 3/8" x 6" x 9 5/8"	5-15P	120 AC	200	15 lb
b	EZT.85899	Twin (2) pump (85820) base warms spouts & (4) pouches	(4) 48 oz	17 3/8" x 11 7/8" x 9 5/8"	5-15P	120 AC	400	25 lb
c	EZT.85920	Twin (2) pump (85820) base warms spouts & (2) pouches	(2) 48 oz	13 15/16" x 11 7/8" x 9 5/8"	5-15P	120 AC	300	20 lb

EZ-Topper® units use specialized pouched toppings. See p 50 for a list of manufacturers or contact your food distributor for 48-oz topping pouches with a 16-mm center fitment.



## Sweet responsibility.

Server pouched topping warmers eliminate product degradation and waste – helping reduce food costs while delivering a superior product.





# Specialty Warmers

## ConserveWell® Utensil Holders

“Our co-op members are always looking for new solutions to improve their costs, operations and, in today’s world, opportunities to be environmentally responsible and conservation minded.

ConserveWell® saved our members **over \$4.5 million** in water and sewer costs.”

Dave Shandy | Equipment Category Manager  
Centralized Supply Chain Services, LLC – Purchasing Co-op

### SEE THE COMPLETE STORY:

PRODUCT VIDEO



APPLICATION GUIDE



ROI CALCULATOR



CUSTOMER TESTIMONIALS



## Making the world a better place, one drop at a time.

Access to pure, clean water is a privilege we don’t take for granted. That’s why we designed the ConserveWell® Utensil Holder to reduce water waste – the responsible replacement for continuous-flow dipper wells.

**2 YEAR WARRANTY**

All ConserveWell® units are backed by a two-year warranty.

- Utensils are safely held above 140°F to protect against bacteria growth
- Programmable countdown timer helps ensure timely water changeouts (also available without timer)
- Drop-in models fit existing counter cutouts of most continuous-flow dipper wells
- Not recommended for utensils with gel-filled handles; [see our application guide](#) for suggestions



### Drop-In Holders

	model/item	description	vessel	dimensions (HxWxD)	plug	voltage	watts	weight
<b>a</b>	<a href="#">CW DI 87770</a>	utensil holder with countdown timer (includes pan 87771)	4 1/2" dia	3 3/8" x 6 13/16" x 10 7/16"	5-15P	120 AC	100	7 lb
	<a href="#">CW DI 87760</a>	utensil holder; no timer (includes pan 87771)	4 1/2" dia	3 3/8" x 6 13/16" x 10 7/16"	5-15P	120 AC	100	7 lb



### Wall-Mount Holders

	model/item	description	pans	dimensions (HxWxD)	plug	voltage	watts	weight
	<a href="#">CW 87750</a>	utensil holder with countdown timer (includes (2) pans 90106)	(2) 3 1/8" x 6"	10 5/8" x 15 1/4" x 5 1/4"	5-15P	120 AC	400	16 lb
<b>b</b>	<a href="#">CW 87740</a>	utensil holder; no timer (includes (2) pans 90106)	(2) 3 1/8" x 6"	7 5/8" x 15 1/4" x 5 1/4"	5-15P	120 AC	400	12 lb





# Specialty Warmers

## Dipping Warmers

- Ideal for dipping ice cream, waffle bowls and cones
- Dip coat topping is gently heated with a low-temperature heating element; no water bath
- Temperature settings, marked as low or high, range from ambient to 150°F
- Stainless steel warmers with up to three wells hold the standard #10 can of cone dip coat or 3-quart jar (94009)
- Cleanup is easy; top and bottom are removable



	model/item	description	capacity	dimensions (HxWxD)	plug	voltage	watts	weight
a	<a href="#">DI-1.92000</a>	single cone dip warmer	3 qt	8 1/8" x 7 5/8" x 9 11/16"	5-15P	120 AC	100	6 lb
b	<a href="#">DI-2.92020</a>	twin cone dip warmer	(2) 3 qt	8 1/8" x 14 5/8" x 9 7/16"	5-15P	120 AC	120	9 lb
c	<a href="#">DI-3.92040</a>	triple cone dip warmer	(3) 3 qt	8 1/8" x 21 5/8" x 9 7/16"	5-15P	120 AC	180	12 lb

## Small-Capacity Warmer

- Small batches of chocolate and candy melts are superior with a water-bath warmer
- Accurate, even heat is applied with a wraparound heating element and temperature-sensing thermostat
- Lift-off lid doesn't interfere with the dipping process
- Stainless steel water-bath warmer includes a 1 1/2-quart bowl, lift-off lid and 1-oz ladle



	model/item	description	capacity	dimensions (HxWxD)	plug	voltage	watts	weight
d	<a href="#">FS-2.82700</a>	warmer with bowl (82707), lid (82706) & ladle (82717)	1 1/2 qt	8 1/8" x 7 3/8" x 8 1/8"	5-15P	120 AC	250	6 lb
	<a href="#">FS-2.82710</a>		1.4 L	20.6 x 18.7 x 20.6 cm	Euro	230 AC		2.7 kg



## Chocolate

is the most popular menued dessert flavor, with a 72.2% U.S. menu penetration.

Datassential SNAP!, 2021



# Specialty Warmers

## IntelliServ® Food Pan Warmer

- End-operated, water-bath warmer is ideal for effective kitchen placement while digital temperature control ensures accurate heating and holding
- Smaller batches keep toppings and sauces at their peak freshness
- NSF listed rethermalizer – quickly heats to a safe serving temperature before bacteria has an opportunity to grow
- Digital display provides instant feedback of heat setting and status
- Open well accepts up to a 1/3-size food pan with a 6-quart capacity; configure to serve with ladles, pumps or squeeze bottles (pans, lids, ladles, pumps and bottles are sold separately)



	model/item	description	capacity	dimensions (HxWxD)	plug	voltage	watts	weight
a	IS-1/3 86090	120V IntelliServ® warmer	6 qt	9 5/16" x 7 15/16" x 15 3/8"	5-15P	120 AC	500	17 lb
	IS-1/3 86338	230V IntelliServ® warmer	5.7 L	23.7 x 20.2 x 39.1 cm	Euro	230 AC	500	7.7 kg
	IS-1/3 86341				UK			



## Adaptable Serving

Customize an IntelliServ® with pumps, ladles or squeeze bottles for topping, finishing or plating.

Stainless steel pumps for 1/3- or 1/6-size food pans, 6" deep are featured on [p.16](#).

### b Sauce Station Components:

item	description
(1) 86338	IntelliServ® warmer, 230V Euro plug
(2) 90089	1/6-size pans, 2 3/4-qt
(2) 90094	1/6-size lift-off lids (not shown)
(2) 87213	6", 1-oz ladles

### c Finishing Station Components:

item	description
(1) 86338	IntelliServ® warmer, 230V Euro plug
(1) 90089	1/6-size pan, 2 3/4-qt
(1) 90094	1/6-size lift-off lid
(1) 87530	squeeze bottle holder, (3) 16-oz
(1) 87213	6", 1-oz ladle

230V models include a required main power switch



## Syrup Warmers/Servers

- Neatly warm and serve syrup for breakfast menu items or a buffet line
- Temperature-sensing thermostat provides accurate heat control with locking design to prevent accidental changes
- Compact, stainless steel syrup warmers with lift-off lid include:
  - 1 1/2-gallon capacity
  - 3-gallon capacity



	model/item	description	capacity	dimensions (HxWxD)	plug	voltage	watts	weight
d	SY 1.5 85480	syrup warmer, faucet dispense	1 1/2 gal	16 1/2" x 8 1/8" x 10 3/4"	5-15P	120 AC	350	8 lb
e	SY 84190	syrup warmer, faucet dispense	3 gal	19 3/16" x 9 7/8" x 12 5/8"	5-15P	120 AC	350	10 lb

## Mix-N-Serve™ Warmer/Mixer

- Ideal for drawn butter, hot chocolate and other foods that should be continuously stirred
- Compact, stainless steel warming dispenser transfers labor from cook line to wait station
- Temperature-controlled thermostat provides accurate heat control with locking design to prevent accidental changes
- Removable melting basket suspends butter solids from stirring agitator
- Separate switches control stir and heat functions
- Spigot-style faucet and removable, 5 1/2-quart food vessel



	model/item	description	capacity	dimensions (HxWxD)	plug	voltage	watts	weight
f	MNS 05578	Mix-N-Serve™ warmer	5 1/2 qt	16 3/16" x 9 1/4" x 8 3/4"	5-15P	120 AC	450	20 lb

## Seafood

is on over 25% of all U.S. menus and is projected to grow +4.6% over the next four years.

Datassential, SNAP! 2022





# Dry Dispensers

Fit to delight.

Dispense precise portions of dry foods, candies, cereals, sweeteners and seasonings. Countertop, wall-mounted or handheld dispensers fit perfectly into your workflow so you can serve better, faster.

**2** YEAR WARRANTY

All Server dry dispensers are backed by a two-year warranty.



**EXPAND & CREATE**  
Flexible, adaptive designs encourage menu expansion and innovation.



**USER FRIENDLY**  
Easy to operate both front and back of house.



**PORTION CONTROL**  
Precise portions reduce waste and increase margins.

## Dry Dispenser Selection Guide

60

### Sweetener & Seasoning



61

### Food & Candy



62

[Visit our online resource](#)

[Consult your rep or find a dealer](#)

[Get in touch](#)

**HOW TO BUY**



# Selection Guide

Which Dry Food Dispenser Is Right For You?



	SWEETENER & SEASONING		FOOD & CANDY	
	SweetStation® p. 61	InSeason® p. 61	Dry Product Dispenser p. 62	SlimLine™ p. 62-63
<b>POPULAR USES</b>	Dry, granular sweeteners like sugar, Equal®, Sweet'N Low®, Splenda®	Dry, granular seasonings like salt or dessert sprinkles	Portioned dry toppings & mix-ins like cookie crumbs, coated candies, nuts	Portioned dry toppings & mix-ins like cookie crumbs, coated candies, nuts
<b>KEY BENEFIT</b>	Tidier, faster alternative to sweetener packets	Handheld precise portions for fry dumps, burgers, desserts	Showcase an eye-catching array of toppings or mix-in ingredients	Slim European styling fits 4 toppings in just 13" of space
<b>CAPACITY</b>	24 oz or 14 oz	10 oz	2 L or 1 L	2 L or 1.4 L
<b>PORTION SIZES</b>	Trigger portions equivalent to portion packets: 1 g or 2.8 g	Trigger portions 1/16, 1/8, 1/4, 1/2, 1 tsp	Increments of 1/8 oz 1/4 oz-2 oz	Portion trays 1/2, 3/4, 1, 1 1/2 oz
<b>ACTION TO DISPENSE</b>	Push trigger	Squeeze trigger	Lift lever up	Pull lever down
<b>SERVING APPLICATION</b>				
Wall-Mount	✓	✓	✓	✓
Countertop			✓	✓
Freestanding/Handheld		✓		

Visit [Dry-Dispensing.com](http://Dry-Dispensing.com) for detailed food application guides, spec sheets and videos.



# Sweetener & Seasoning

## SweetStation® Sweetener Dispensers

- Improve drive-thru speed of service with preset sweetener portions at the touch of a button
- Wall-mount rack allows for single-handed operation
- Color-coded triggers and decals make brand identification easy; white, yellow, pink and blue
- 24-oz dispensers hold: 206 2.8-g servings of sugar or 465 1-g sweetener servings
- 14-oz dispensers hold: 120 2.8-g servings of sugar or 271 1-g sweetener servings



model/item	description	portion triggers	capacity	dimensions (HxWxD)	weight
SWTS-324 80103	triple sweetener dispenser station	1 (2.8 g) white	(3) 24 oz	13 1/8" x 11 15/16" x 5"	7 lb
SWTS-314 80104		2 ea (1 g) yellow, pink & blue	(3) 14 oz	9 7/8" x 11 15/16" x 5"	
a SWTS-424 80101	quad sweetener dispenser station	1 (2.8 g) white	(4) 24 oz	13 1/8" x 15 11/16" x 5"	8 lb
SWTS-414 80102		3 ea (1 g) yellow, pink & blue	(4) 14 oz	9 7/8" x 15 11/16" x 5"	

## InSeason® Seasoning Dispensers

- Ensure precise ingredient portions, consistent flavor and nutritional transparency
- Handheld dispensers with Spread or Drop dispense pattern
- Color-coded portion triggers make portion identification easy – includes (3)
- Portion Shaker spreads seasoning over non-uniform foods (sold separately)
- Wall-mount rack neatly holds dispensers when not in use (sold separately)

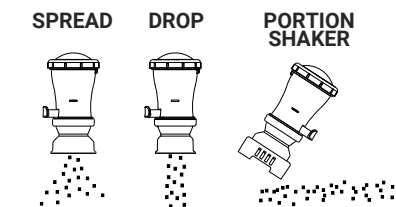

model/item	description	area of use	portion triggers	capacity	dimensions (HxWxD)	weight
b INS 87100	spread pattern dispenser, Polysulfone*	up to 325°F	1/4 tsp black, 1/8 tsp blue & 1/2 tsp green	10 oz	6 11/16" x 3 1/4" x 3 3/8"	1 lb
c INS 87880	spread pattern dispenser, clear Tritan™	up to 190°F				
INS 87090	drop pattern dispenser, Polysulfone*	up to 325°F	1/8 tsp tan, 1/8 tsp burgundy & 1/4 tsp black	10 oz	6 11/16" x 3 1/4" x 3 3/8"	1 lb
d INS 87870	drop pattern dispenser, clear Tritan™	up to 190°F				
e 87282	portion shaker attachment	up to 325°F	fits spread pattern only	N/A	N/A	1 lb
80085	triple wall-mount rack		dispensers sold separately		5" x 11 15/16" x 5"	3 lb
87135	quad wall-mount rack (see image a above)	N/A			5" x 15 11/16" x 5"	

\*Polysulfone models contain BPA



# Food & Candy Wall-Mount Dispensers

- Showcase your dry toppings and ingredients in a merchandising dispenser
- Designed to create a wall-mounted station of any number of ingredients; each dispenser needs just 5" of space
- Accurately dispense ¼-oz to 2-oz portions from a 1- or 2-liter hopper; adjustable in ¼-oz increments
- Not recommended for powders or sticky products, such as crushed candy bars

NSF ADA compliant | No wrist twisting or tight grasping to dispense



	model/item	description	capacity	servings	dimensions (HxWxD)	weight
	DPD 86680	wall-mount dry dispenser, single	2 L	(270) ¼ oz - (33) 2 oz	17 7/16" x 4 11/16" x 6 5/16"	4 lb
a	DPD 86670	wall-mount dry dispenser, single	1 L	(135) ¼ oz - (16) 2 oz	13 9/16" x 4 11/16" x 6 5/16"	
b	DPD 86660	wall-mount dry dispenser, triple	(3) 2 L	(270) ¼ oz - (33) 2 oz	17 7/16" x 14 11/16" x 6 5/16"	11 lb
	DPD 86650		(3) 1 L	(135) ¼ oz - (16) 2 oz	13 9/16" x 14 11/16" x 6 5/16"	10 lb

## SlimLine™ Wall-Mount Dispensers

- Showcase any number of dry toppings and ingredients; each dispenser needs just over 3" of space
- Serve up product consistency with precise portions from a 2-liter or 1.4-liter capacity hopper for locations with limited vertical space or operators looking to refresh ingredients more frequently
- Ideal for soft-serve or yogurt toppings such as granola, crisped rice and crushed cookies; not recommended for powders or crushed candy bars

NSF ADA compliant | No wrist twisting or tight grasping to dispense



	model/item	description	capacity	servings	dimensions (HxWxD)	weight
	DFD 88750	wall-mount SlimLine™ dry dispenser, single	2 L	(135) ½ oz - (45) 1 ½ oz	17 9/16" x 3 3/16" x 6 15/16"	5 lb
a	DFD 89264	wall-mount SlimLine™ dry dispenser, single	1.4 L	(94) ½ oz - (31) 1 ½ oz	13 5/8" x 3 3/16" x 6 15/16"	4 lb
	DFD 88760	wall-mount SlimLine™ dry dispenser, double	(2) 2 L	(135) ½ oz - (45) 1 ½ oz	17 9/16" x 6 7/16" x 6 15/16"	8 lb
	DFD 88770		wall-mount SlimLine™ dry dispenser, triple	(3) 2 L	(135) ½ oz - (45) 1 ½ oz	17 9/16" x 9 11/16" x 6 15/16"
b	DFD 88780	wall-mount SlimLine™ dry dispenser, quad	(4) 2 L	(135) ½ oz - (45) 1 ½ oz	17 9/16" x 12 15/16" x 6 15/16"	16 lb
	DFD 89267		(4) 1.4 L	(94) ½ oz - (31) 1 ½ oz	13 5/8" x 12 15/16" x 6 15/16"	15 lb



## Slim Satisfaction

SEE OUR APPLICATION GUIDE



Less than 7" of wall space (for 2).

Clear-view merchandiser drives impulse sales.

Extremely durable design.

Consistent, accurate portions reduce waste and save you money.

Color-coded trays identify serving size.



## SlimLine™ Countertop Dispensers

- Showcase your dry toppings and ingredients
- Accurately dispense ½-, ¾-, 1- & 1½-oz portions from a 2-liter hopper
- Not recommended for powders or sticky products, such as crushed candy bars

NSF ADA compliant | No wrist twisting or tight grasping to dispense



	model/item	description	capacity	servings	dimensions (HxWxD)	weight
	DFD 88730	SlimLine™ countertop dispenser, double	(2) 2 L	(135) ½ oz - (45) 1 ½ oz	26 1/2" x 6 3/4" x 12 1/16"	15 lb
c	DFD 88740	SlimLine™ countertop dispenser, triple	(3) 2 L	(135) ½ oz - (45) 1 ½ oz	26 1/2" x 10" x 12 1/16"	22 lb



# Parts & Price Guide

Dedication builds precision.

Trust matters. For 75 years, our holding and dispensing equipment has been designed to impress and engineered to last. Shipped undamaged and in working order. Guaranteed.



## Parts & Service

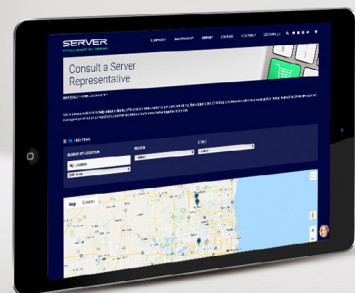

65

 [Visit our online resource](#)

 [Consult your rep or find a dealer](#)

 [Get in touch](#)

**HOW TO BUY**

## Warmer Parts



66

## Pump Parts

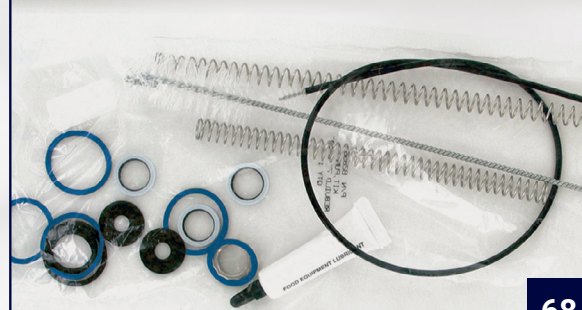

68

## Price Guide

72

## Parts & Service

Server Products equipment is sold through a large network of dealers, with list prices in this book as a reference point. For competitive net pricing, contact your local dealer/distributor or visit [server-products.com/How-to-Buy](http://server-products.com/How-to-Buy) to locate a dealer.

**2 YEAR WARRANTY**

All Server products are backed by a two-year warranty.

- Covers defects in materials and workmanship
- Excludes replacement of wear parts like O-rings, seals and springs
- Call 800.558.8722 for a Return Material Authorization Number
- Repairs are performed at our manufacturing facility in Richfield, Wisconsin
- You cover return freight costs to Server Products for evaluation
- If under warranty, your repaired unit is returned at no charge to you via ground
- 48-hour turnaround (from receipt) is common
- Please note: we operate on a five-day workweek
- A complete warranty statement is available at [server-products.com/Parts-Service](http://server-products.com/Parts-Service)

## Returns for Credit

- Need to occur within 90 days of purchase
- Must be in new and unused condition and include all original packaging and accessories
- Custom or non-catalog products are non-returnable and non-cancellable
- For safety reasons, electrical components (heating elements, thermostats, etc.) are not returnable
- A standard restocking fee of 20% applies
- Call 800.558.8722 for a Return Material Authorization Number

## Return Shipping Information

- Packaging is important – Server is not responsible for equipment damaged in shipping
- Items should not be returned without a Return Material Authorization Number (RMA #)
- To ensure timely processing, please put your RMA # on the box and ship to:  
C/O Repair Department RMA #\_\_\_\_ | Server Products, Inc. | 3601 Pleasant Hill Road | Richfield, WI 53076

## Equipment & Parts Purchasing

- Please choose carefully; for safety reasons, electrical components are not returnable
- Purchase through your dealer
- Prices are FOB Richfield, WI 53076 – shipping charges not included

When Looking for Foodservice Equipment Parts, Look to Parts Town.

  
Always Genuine OEM

  
The Most In-Stock Parts on the Planet

  
Breakthrough Innovations

  
Personalized Customer Experience

  
Same Day Shipping

**Partstown**  
Get real parts faster

[partstown.com](http://partstown.com) | 800.438.8898

## Equipment & Parts Assistance

- Contact our customer care team at: 800.558.8722 (M-F 8:00 am to 4:30 pm CT)
- Live chat available at [server-products.com](http://server-products.com) during business hours
- Please know your Part Number, Model and Series information located on the bottom of the lid for pumps or the back of the unit for heated and countertop units



# Parts & Price Guide

## Replacement Parts – 120 Volt Warmers

model (120v)	thermostat	thermal cutout	heating element	water vessel
	includes: thermostat & wrench	thermal cutout	heating element, wire & terminals	water vessel
BS	55034 series 81>		05256 series 80>	
BSA	55034 series 81>		05256 series 80>	
BS-SS, BSW-SS BSWI-SS	86899	86766 series 04K>	86761 series 04K> 81051 series <04K	86785
BSW, BSWI	55224 series 81>		81051	81116
CW-DI	11652	11652	87781	87771 (pan)
CW-T, CW	88671	87743	87733	90106 (pan)
DI-1 DI-2 DI-3	55053 series 81>		DI-1 92061 DI-2 92063 DI-3 92064	
EZT-S (85860)	100003	85674	85674	85686
EZT-S (85790)	100003 Series >15H 84999 Series <15H	85674 Series >15 85923 Series <15	85674	85686
EZT-S (85880)	100003 Series >15H 84999 Series <15H	85674 Series >15 85923 Series <15	85674	85686
EZT (85899)	100003	85674 Series >15H 85923 Series 08L –15H	85674	85686
EZT (85920)	100003	85674	85684	85708
FS-2	100003 series 13G> 55034 series 89 55224 series 81-88	81037 series 13G> 81036 series <13G	83963 series 13G>	81407 series 13G>
FS, FSP, FS-4, FS-4 Plus	100003 series 12L> 55034 series 81-96G 81040 series < 81	81037 series 12L> 81036 series <12L	81297 series 12L> 81051 series <12L	81278 series 12L>
FS-7	84017	04627 series 87> 84035 series <87	84070	84056 series 89K>
FS-7SS	90186	04627		
FS-11	84017	04627 series 87> 84035 series <87	84080	84128 series 89I>
FS-11SS	90186	04627		
Triple FS-4, Triple FS-4 Plus Twin FS, Twin FSP, Twin FS/FSP Twin FS-4, Twin FS-4 Plus	100003 series 13C> 55224 series 81-96G 81280 series <81	81037 series 13C> 81036 series <13C	81299 series 13C> 85912 <13C (triple) 81051 <13C (twin)	81116
FS-20SS	90018	04397	90183	90068
FSA	84999 series 09J> 90186 series <09J	85113 series 90J>		
FS-4SS, FS-SS, FSP-SS FSPW-SS, FSPWI-SS	90186 series 04K> 55224 series <04K	86766 series 04K>	86761 series 04K> 81051 series <04K	86785
FSPW, FSPWI HSSW, HSSWI	55224 series 81>		81051	81116
IS-1/8	86274 (control board)	86309	86149	86148
KS	84017	04627 series 87>	84354	84357

Before ordering, please reference the parts purchasing information on p.79. For safety reasons, electrical components are not returnable.

## Understanding Series Information

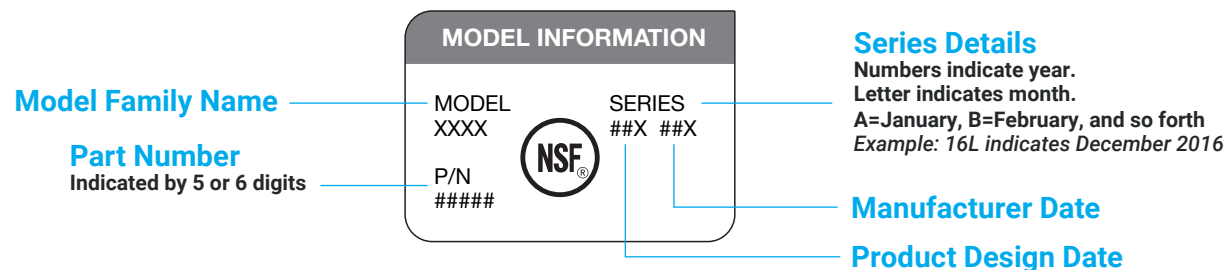

## Replacement Thermostats, Heating Elements & Water Vessel Kits – 230 Volt Units

model (230v)	thermostat	thermal cutout	heating element kit	vessel replacement kit*	replacement water vessel only**
FS-2	55034 series 89> 55224 81-88	81165			
FS, FSP, FS-4	55034 series 81>97L	81165	81349		
FS-7	84017	04627 87-99J 84035 <87	84074 series 99J>		84056 series 89K>
FS-7SS	90186	86491	84074		
FS-11	84017	04627 87-99J 84035 <87	84365 series 99J>		84128 series 89I>
FS-11SS	90186		84365		
Twin FS, Twin FSP, Twin FS-4	55224 series 81>98F	81236 series 98F 81036<98F	81349	81087	81116
KS	84017	04627 87-99J	84365 series 99J>		84357
LFS, LFS-4, LFSP, LNCSL, LNCSW, LNCSWI, HSSW, HSSWI, FSPW, FSP- WI, FS RECT, FSP RECT, FS-4 RECT	55224 series 81>		81349	81087	81116
BSA	55034				
BS	55034 series 81>				
LBS, LBSW, LBSWI, BSW, BSWI	55224 series 81>		81349	81087	81116
FS-SS, FSP-SS, FSPW-SS, FSPWI-SS FS-4SS	90186 series 03L> 81224 <03L	86491 series 04K	81349		86785
BS-SS, BSW-SS, BSWI-SS	86899	86491 series 04K>	81349		86785
CW-DI	11662	11662	87782		87771
CW-T, CW	88671	87743	88669		90106

Before ordering, please reference the parts purchasing information on p.69. For safety reasons, electrical components are not returnable.

\*Vessel Replacement Kits consist of a vessel, heating element and thermostat bracket.

\*\*Replacement Water Vessel Kits only contain a water vessel assembly – order heating element kit if needed.



# Parts & Price Guide

## Parts Breakdowns By Pump Style

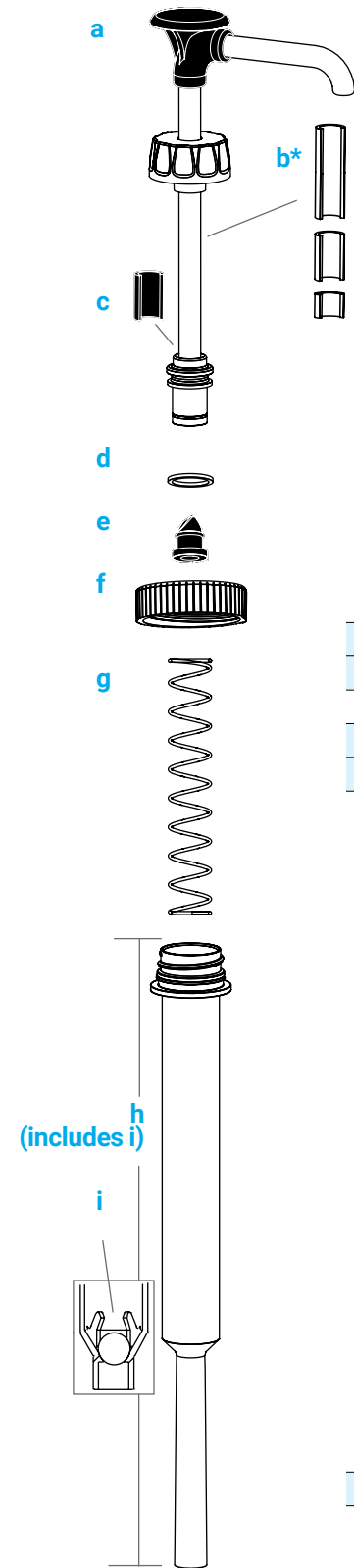

### Server Eco Pumps™ (Except BP-1 Thick 88220)

Cleaning Brush, 1 1/4" Dia.	82049
Cleaning Brush, 21" Long	82526
Food Equipment Lubricant, 1/4 oz	40179
<b>b*</b> Optional: Gauging Collars	
1/2 oz Portion Reduction Collar	88205
1/4 oz Portion Reduction Collar	88204
1/8 oz Portion Reduction Collar	88313
<b>c</b> Stop Collar (required for operation)	88409

Server Eco Pumps™ are NSF listed. Plus, clean-in-place certification means proper cleaning can be done without disassembly.

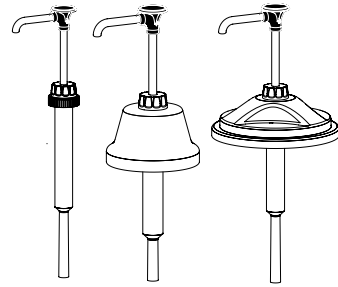

Not all pump styles are pictured.

pump/model	a head assembly	d seal	e pinch valve	f cap/lid	g spring	h cylinder assembly	i stainless steel ball
88000 BP-1, 38 mm	88303	83005	88202	88016	88166	88496	06022
88010 BP-1, 110 mm							
88020 BP-1, Crock	88304	83005	88202	88056	88166	88312	06022
88180 BP-1/4, 28 mm		88162	88188	88213 & 88276	88189	88085	88258
88190 BP-1/2, 28 mm	88232				88233	88089	

### Server Eco Pump BP-1 Thick

Cleaning Brush, 1 1/4" Dia.	82049
Cleaning Brush, 21" Long x 1/2"	84257
Food Equipment Lubricant, 1/4 oz	40179
<b>b*</b> Optional: Gauging Collars for BP-1 Thick Pump (only)	
1/2 oz Portion Reduction Collar	88879
1/4 oz Portion Reduction Collar	88888
1/8 oz Portion Reduction Collar	88887
<b>c</b> Stop Collar (fixed, incorporated into head)	none

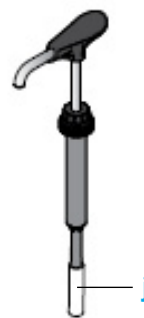

pump/model	a head assembly	d seal	e pinch valve	f cap/lid	g spring	h cylinder assembly	i stainless steel ball	j extension tube, 2 1/2"
88220 BP-1, Thick	89215	100345	88203	88016	88166	88496	06022	88315

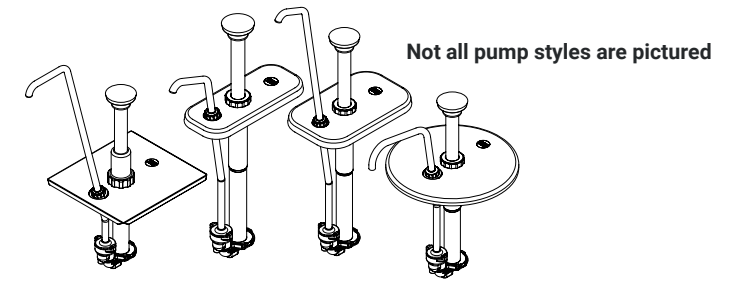
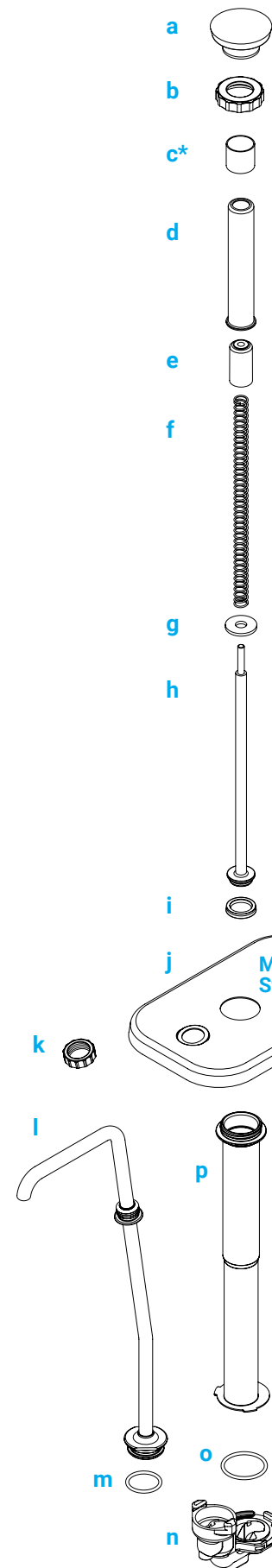

Not all pump styles are pictured

### Stainless Steel Pumps

Cleaning Brush, 1 1/4" Dia.	82049
Cleaning Brush, 21" Long	82526
Cleaning Brush, 21" Long (used with 1/2" tube)	84257
Food Equipment Lubricant, 1/4 oz	40179
<b>a</b> Knob, Black	82023-000
<b>b</b> Locking Collar	See Chart
<b>c*</b> Optional: Gauging Collars	
<b>For 1-oz &amp; 1 1/4-oz Pumps:</b>	
1/4 oz Portion Reduction Collar	82022
1/8 oz Portion Reduction Collar	83529
<b>For 2-oz Pumps:</b>	
1/2 oz Portion Reduction Collar	88568
1/4 oz Portion Reduction Collar	88571
<b>d</b> Head Tube	See Chart
<b>e</b> Head Insert	82018
<b>f</b> Spring, 7"	82016
Spring, 10"	82077
<b>g</b> Washer (for 1- & 1 1/4-oz pumps)	82015
Washer (for 2-oz pumps)	87602
<b>h</b> Piston	See Chart
<b>i</b> Seal Assembly (for 1- & 1 1/4-oz pumps)	83003
Seal Assembly (for 2-oz pumps)	88565
<b>j</b> Lid (See Parts Breakdown at server-products.com)	
<b>k</b> Discharge Tube Nut	82027
<b>l</b> Discharge Tube	See Chart
<b>m</b> Discharge Tube O-Ring, 1"	05127
<b>n</b> Valve Body, Captured Balls	See Chart
<b>o</b> Cylinder O-Ring/Gasket	See Chart
<b>p</b> Cylinder O-Ring/Gasket	See Chart
St. St. Ball, 1/2" (in pumps prior to 1999)	06022

NOTE: Used to determine parts in chart on p.72-73

Wear parts like seals, springs and o-rings can be replaced, so you shouldn't need to buy a new complete pump again.





# Parts & Price Guide

## Stainless Steel Pumps – Replacement Parts Chart

pump/model	pk parts kit	b locking collar	d head tube	f spring	h piston and seal assy	l discharge tube	n valve body kit	o o-ring/gasket	p cylinder
06110 BSW	82898	82021	82017	82016	100075	82493	82431	82323	82336
67540 CPSS-F					100075				
67570 CPSS-FL	82898	82021	82017	82016	82013	82375	82433	82323	82336
81320						82485			
82000 SP	82898	82021	82017	82016	100075	82489	82431	82323	82336
82070 FP	82898	82021	82078	82077	83398	82476	82431	82323	82348
82100 FP-200	82898	82106	82017	82016	100075	82497	82431	82323	82358
80030 FP-200 DI	82898	82106	82017	82016	100075	80032	82431	82323	82358
82120 FP-V	82898	82021	82078	82077	83398	82487	82431	82323	82348
82130 FP-200V	82898	82106	82017	82016	100075	82499	82431	82323	82358
82520 FPV-DI	82898	82021	82078	82077	82076	82515	82431	82323	82348
82740 FPEC						82643			
82800 FPEC	83062	83412	82017	82016	100075	82806	82635	88554	82362
82990 FP-DI	82898	82021	82078	82077	83398	82495	82431	82323	82348
83000 CP-10	82898	82021	82017	82016	100075	82371	82431	82323	82336
83020 CP-3							82431		
83110 CP-G (120 mm)									
83120 CP-G (110 mm)	82898	82021	82017	82016	100075	82373	82433	82323	82336
83130 CP-G (89 mm)									
83200 CP-6 ½									
83220 CP-8 ½									
83910 CP-8 ½ L	82898	82021	82017	82016	100075	82374	82431	82323	82336
83240 CP-10 ½									
83300 CP-200	82898	82106	82017	82016	100075	82372	82431	82323	82358
83330 CP-F	82898	82021	82078	82077	83398	82369			82348
83400 CP-¼									
83420 CP-¼	82898	83412	82017	82016	100075	82376	82431	82323	82362
83430 CP-⅜									
83433 CP-⅜ (Tall)									
83437 CP-¼ (Tall)	82898	83412	82017	82016	100075	83431	82431	82323	82362
83441 CP-⅜ (Tall)									
83447 CP- ½ DL (Tall)									
83480 CP-½ DL		83412				82376			82362
83920 CP-5	82898	82021	82017	82016	100075	82374	82431	82323	82336
85050 FPSA	83062	82106	82017	82016	100075	85065	85038	88554	82358
85300 FP-V Slim	82898	82021	82078	82077	83398	82487	82431	82323	82348
85310 FP-200V Slim	82898	82106	82017	82016	100075	82499	82431	82323	82358
85320 SP-3	82898	82021	82017	82016	100075	85324	82431	82323	82336
85340 CP-F Slim	82898	82021	82078	82077	83398	82369	82431	82323	82348
85350 FP-200 Slim	82898	82106	82017	82016	100075	82497	82431	82323	82358
85370 FP-DI Slim						82495			
85380 FPV-DI Slim	82898	82021	82078	82077	83398	82515	82431	82323	82348
85820 FP-EZT	83062	83412	82017	82016	100075	85827	82635	88554	82362
86312 FP-¼	82898	83412	82017	82016	100075	86314	82431	82323	82362

## Stainless Steel Pumps – Replacement Parts Chart (cont'd)

pump/model	pk parts kit	b locking collar	d head tube	f spring	h piston and seal assy	l discharge tube	n valve body kit	o o-ring/gasket	p cylinder
86750 TP-200V		82106	82017	82016	100075	82459			82358
86760 TP-V		82021	82078	82077	83398	82455			82348
86770 TP-200V (Slim)	82898	82106	82017	82016	100075	85459	82431	82323	82358
86780 TP-V (Slim)		82021	82078	82077	83398	82455			82348
87300 CP-¼						82376			
87310 FP-¼	82898	83412	82017	82016	10075	83074	82431	82323	82362
87620 CP-8 ½ 2 oz	88628	87601	88556	82077	88558	88569	85891	88554	88561
87640 CP-¼ 2 oz	88628	87603	88556	82077	88589	82376	82431	88554	88558
87660 CP-F 2 oz		87601	88556	82077	88599	82369	82431	88554	88598
87670 FP-200V 2 oz	88628	87601	88556	82077	88558	82499	82431	88554	88561
87680 CP-10 ½ (2 oz)	88628	87601	88556	82077	88558	88569	85891	88554	88561
94010 CSM	94043	82021	82017	82016	100075	82427	82431	82323	82336
94040 CSP 1 oz	82898	83412	82017	82077	100075	94084	82431	82323	94093
94080 MMS	82898	82021	82017	82016	82013	82424	82431	82323	82336

For more detail, Parts Breakdowns are available at [server-products.com](http://server-products.com)



### Simplify Ordering with a Parts Kit! (column pk above)

82898 Parts Kit Includes:	
Cleaning Brush, 1 ¼" Dia.	(1) 82049
Cleaning Brush, 21" Long	(1) 82526
Food Equipment Lubricant, ¼ oz	(1) 40179
e Head Insert	(1) 82018
f Spring, 7"	(1) 82016
Spring, 10"	(1) 82077
g Washer (1 & 1 ¼ oz)	(2) 82015
i Seal Assembly (1 & 1 ¼ oz)	(3) 83003
m Discharge Tube O-Ring, 1"	(3) 05127
o Cylinder O-Ring (1 & 1 ¼ oz)	(5) 82323
k Discharge Tube Nut	(1) 82027

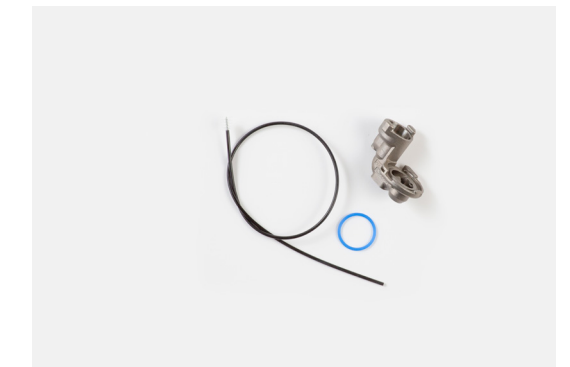

### Valve Body Kits Include (column n above)

Valve Body, Captured Balls	Varies
O-Ring, 1 5/16"	82323
Brush, 21"	82526



# Parts & Price Guide

## Express Pumps Manual, Pouched Product Breakdown

Complete Spare/Repl. Pump	07794
Cleaning Brush, 1 1/4" Dia.	82049
<b>a</b> Dome, Black	07383
<b>b</b> Pinch Valve	07798
<b>c</b> Pump Housing	07388
<b>d</b> Discharge Fittings: .394" (large opening)	(1) ea 07797
.256" (medium opening)	07796
.156" (small opening)	07795
<b>e</b> Silicone Tube	07089
<b>f</b> Connector, 16 mm	07381

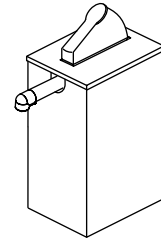

Example Unit

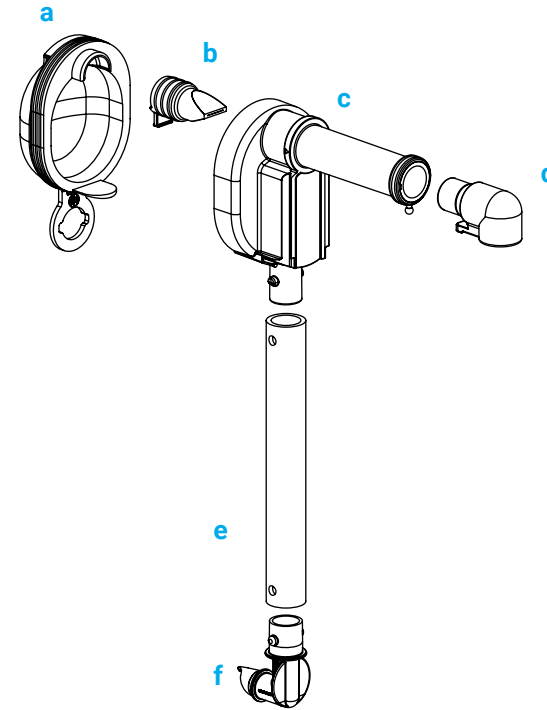

For new Direct-Pour Express Pump breakdown see:  
• Express, Manual, Direct-Pour Pump Breakdown [100239](#)

## Server 2024 Price Guide (04099 – 07079)

item	description	list price	page
04099	COVER, ROCKER SWITCH	\$11.44	
04159	GUARD, SWITCH	\$19.37	
04397	CUT-OUT, THERMAL, 216C	\$17.21	
04544	SWITCH, SNAP-IN ROCKER	\$5.80	
04627	CUT-OUT, THERMAL, 184C	\$17.41	
04973	GUARD, KNOB	\$32.03	
05127	O-RING, 1 IN, SILICONE	\$1.45	
05256	ELEMENT, HEATING, 120V 350W	\$94.57	
05257	BRACKET, ELEMENT, HEATING	\$8.83	
05551	MOTOR, GEAR	\$341.16	
05557	VESSEL ASSEMBLY	\$388.03	
05559	KIT, STIR BAR	\$130.89	
05561	BASE, STIR BAR	\$17.31	
05563	MAGNET, MIX-N-SERVE	\$86.39	
05569	ELEMENT, HEATING, 120V 400W	\$160.56	
05573	BAR, STIR, MAGNET	\$95.79	
05574	FAUCET	\$59.14	
05575	NUT, WING	\$12.02	
05576	C-RING	\$5.08	
05578	MIX-N-SERVE	\$1,572.17	57
05579	SHROUD ASSEMBLY	\$251.19	
05595	COVER	\$140.02	
05596	LABEL, GROUND	\$1.28	
05599	TUBE, RUBBER, 1/2 IN	\$3.48	

item	description	list price	page
05607	BAR, STIR ASSEMBLY LH	\$92.88	
05608	LID ASSEMBLY, MIX-N-SERVE	\$124.97	
05609	KNOB-BLACK, LH	\$26.83	
06022	BALL, 1/2 IN DIA, SS	\$2.41	
06110	PUMP ONLY FOR BUTTER SERVER	\$347.13	
07000	SERVER EXPRESS-RECTANGULAR, BLACK	\$401.91	13
07010	SERVER EXPRESS-ROUND	\$401.91	13
07014	LEVER	\$7.67	
07015	KIT, REPLACEMENT ROLLER	\$29.14	
07020	SERVER EXPRESS SINGLE DROP-IN	\$511.54	13
07036	RAMP	\$35.44	
07040	SERVER EXPRESS TRIPLE	\$1,407.50	29
07046	VESSEL, RECTANGULAR, EXPRESS, PLSTC	\$203.37	
07047	VESSEL, ROUND, EXPRESS, PLASTIC	\$203.37	
07048	LID, EXPRESS, RECTANGULAR	\$47.53	
07050	SERVER EXPRESS TRIPLE DROP-IN	\$1,498.06	29
07051	LID, EXPRESS, ROUND	\$138.62	
07052	LID ASSY, EXPRESS, ROUND-COMPLETE	\$158.48	
07053	LID ASSY, EXPRESS RECT-COMPLETE	\$109.81	
07055	LID, EXPRESS SINGLE	\$114.61	
07056	ROLLER	\$7.67	
07057	LID ASSY, EXPRESS SINGLE-COMPLETE	\$159.56	
07060	SERVER EXPRESS QUINTUPLE	\$1,722.04	29
07079	LID, EXPRESS TRIPLE	\$91.08	

## Server 2024 Price Guide (07083 – 11052)

item	description	list price	page
07083	LID ASSY, EXPRESS TRIPLE-COMPLETE	\$265.64	
07089	TUBE, PLASTIC, 7 IN	\$15.58	
07104	LID, EXPRESS QUINTUPLE	\$171.56	
07105	LID ASSY, EXPRESS QUINT-COMPLETE	\$504.28	
07114	LID, EXPRESS SEXTUPLE	\$381.72	
07115	LID ASSY, EXPRESS SEXTUPLE-COMPLETE	\$428.92	
07125	SERVER EXPRESS SINGLE	\$511.54	13
07126	SHROUD, WELDED ASSEMBLY	\$248.67	
07131	DECAL SET, CONDIMENT	\$6.36	
07140	SERVER EXPRESS TWIN	\$1,008.75	29
07141	CONNECTOR, 18MM, BLACK	\$31.85	
07159	SUPPORT, POUCH, EXPRESS	\$51.16	
07161	PIN, HINGE, SLIC	\$3.72	
07185	LID, EXPRESS QUADRUPLE	\$140.52	
07186	LID ASSY, EXPRESS QUAD-COMPLETE	\$417.66	
07200	SERVER EXPRESS QUADRUPLE	\$1,571.13	29
07268	FITTING, DUCKBILL	\$22.54	
07291	TRAY, DRIP ASSEMBLY, SINGLE	\$109.61	
07295	TRAY, DRIP ASSEMBLY, TRIPLE	\$123.90	
07299	TRAY, DRIP ASSEMBLY, QUINTUPLE	\$133.45	
07300	TWIN STAND-SERVER EXPRESS	\$884.85	13
07304	SHROUD ASSEMBLY	\$290.57	
07309	TRAY, DRIP ASSY,SEXTUPLE,STAINLESS	\$255.21	
07324	TRAY, DRIP ASSEMBLY, QUADRUPLE	\$130.27	
07327	KIT, SHROUD ASSEMBLY-RECT DI	\$315.58	
07328	KIT, SHROUD ASSEMBLY-TRIPLE	\$595.36	
07329	KIT, SHROUD ASSEMBLY-TRIPLE DI	\$670.07	
07331	KIT, SHROUD ASSEMBLY-QUADRUPLE	\$783.92	
07332	KIT, SHROUD ASSEMBLY-QUADRUPLE DI	\$859.51	
07333	KIT, SHROUD ASSEMBLY-QUINTUPLE	\$911.02	
07334	KIT, SHROUD ASSEMBLY-QUINTUPLE DI	\$1,043.35	
07341	LID, EXPRESS TWIN	\$85.38	
07342	LID ASSEMBLY, EXPRESS TWIN-COMPLETE	\$141.11	
07343	KIT, SHROUD ASSEMBLY-TWIN	\$288.98	
07344	KIT, SHROUD ASSEMBLY-TWIN DI	\$401.68	
07345	KIT, SHROUD ASSEMBLY-RECT	\$271.53	
07381	CONNECTOR, 16MM	\$5.24	
07383	DOME, PUMP, .218, 45-50 DURO, BLACK	\$20.97	
07386	HOUSING, PUMP	\$12.99	
07388	HOUSING, PUMP ASSEMBLY, CLR	\$20.49	
07398	PUMP, ADA, PINCH VALVE, W/(1) 07796	\$86.74	
07399	DOME, PUMP, .281, 55 DURO, BLUE	\$40.54	
07402	LID, EXPRESS, PLASTIC	\$29.49	
07403	LINK	\$12.08	
07404	TUBE, PLASTIC, 5 IN	\$20.17	
07405	PUMP, ADA, 55 DURO DOME, SHORT,16MM	\$100.15	
07429	FOOT, RUBBER	\$2.31	
07455	SHROUD ASSEMBLY, CUSTOM, WHT-BLANK	\$182.69	
07456	CUSTOM EXPRESS, WHITE-BLANK	\$428.91	
07500	EXTREME COUNTERTOP DISPENSER	\$602.07	14

item	description	list price	page
07501	LID, EXTREME	\$64.61	
07502	HOSE, RIGHT ANGLE	\$43.31	
07505	SPRING, TORSION	\$26.83	
07507	CONNECTOR, ANTI-CHOKE, STRAIGHT	\$13.35	
07508	PLATE, EVACUATION	\$39.74	
07518	PUMP ASSEMBLY, EXTREME	\$127.25	
07527	LID, EXPRESS SEXTUPLE, SLIM	\$259.86	
07531	LID, EXPRESS TWIN, SLIM	\$64.86	
07542	LABEL, EXTREME COUNTERTOP	\$3.62	
07545	KIT, SHROUD ASSEMBLY-SLIM TWIN	\$273.81	
07553	SHROUD ASSEMBLY	\$779.93	
07554	LID, EXPRESS QUADRUPLE, LOCKABLE	\$147.74	
07558	KIT, SHROUD ASSEMBLY-SLIM SEXTUPLE	\$483.58	
07573	LID, EXPRESS QUADRUPLE, SLIM	\$164.08	
07576	TUBE, DISCHARGE ADA	\$88.01	
07578	KIT, SHROUD ASSEMBLY-SLIM QUADRUPLE	\$350.85	
07592	LID, EXPRESS SINGLE, ROUND CORNERS	\$82.97	
07644	CORNER, PROTECTIVE	\$1.32	
07645	KIT, PROTECTIVE CORNER	\$3.90	
07664	TUBE, DISCHARGE ADA (UNIVERSAL)	\$97.38	
07669	TUBE, PLASTIC, 9 1/2 IN	\$20.49	
07672	SHROUD ASSEMBLY	\$311.27	
07691	LID, WELDED ASSY, EXPRESS SGL, LP	\$120.91	
07794	PUMP, ADA, PINCH VALVE, LONG	\$94.37	
07795	FITTING, DISCHARGE, .156-SMALL	\$15.58	
07796	FITTING, DISCHARGE, .256-MEDIUM	\$15.58	
07797	FITTING, DISCHARGE, .394-LARGE (BLK)	\$15.58	
07798	VALVE, PINCH, ADA PUMP, LARGE	\$21.60	
07811	SUPPORT, POUCH 3 GAL	\$70.30	
07813	SPRING, TORSION	\$23.51	
07814	PLATE, EVACUATION	\$39.74	
07827	FITTING, DISCHARGE, .394-LARGE (BLU)	\$15.73	
07843	LID, EXPRESS QUADRUPLE, ROUNDED	\$195.43	
07848	SHROUD ASSEMBLY	\$862.83	
07851	LID, EXPRESS QUINTUPLE, ROUNDED	\$208.68	
07856	SHROUD ASSEMBLY	\$940.76	
07857	SHROUD ASSEMBLY	\$873.89	
07863	SHROUD ASSEMBLY	\$791.83	
07865	LID, EXPRESS TRIPLE, ROUNDED	\$91.08	
07866	LID ASSY, TRIPLE, ROUNDED-COMPLETE	\$235.91	
07867	LID ASSY, QUAD, ROUNDED-COMPLETE	\$313.43	
07868	LID ASSY, QUINT, ROUNDED-COMPLETE	\$504.28	
07888	DOME, PUMP, .281, 60 DURO, RED	\$40.54	
07937	PUMP, ADA, 55 DURO DOME, SHORT,18MM	\$100.15	
10045	SCREW, SET, 8-32 X 1/4	\$0.90	
11037	CORD ASSEMBLY, 18GA	\$33.29	
11042	CORD ASSEMBLY (CONT EURO)	\$60.44	
11044	CORD ASSEMBLY (UK)	\$69.23	
11048	WIRE ASM, 18GA, STRD, 200C, WHT, 7 IN	\$6.70	
11052	WIRE ASM, 16GA, STRD, 250C, 7 IN	\$5.01	



## Server 2024 Price Guide (11189–80992)

item	description	list price	page
11189	CORD ASSEMBLY, 18GA	\$25.50	
11197	BUSHING, STRAIN RELIEF, RT ANGLE	\$1.08	
11198	BUSHING, STRAIN RELIEF	\$0.49	
11201	BUSHING, STRAIN RELIEF, 18/3	\$0.49	
11202	BUSHING, STRAIN RELIEF, 14/3	\$0.84	
11203	BUSHING, 5/16 HOLE	\$0.58	
11207	BUSHING, 9/16 HOLE	\$3.90	
11212	CORD ASSEMBLY, 18GA	\$28.49	
11216	CORD ASSEMBLY, 14GA	\$38.67	
11223	CORD, 18GA, 6'	\$29.57	
11227	CORD ASSEMBLY, 14GA	\$46.10	
11228	BUSHING, STRAIN RELIEF, RT ANG,14/3	\$3.90	
11230	CORD ASSEMBLY, 18GA	\$33.21	
11277	CORD ASSEMBLY (CONT EURO)	\$69.65	
11280	CORD ASSEMBLY (AUST)	\$77.51	
11286	CORD ASSEMBLY (UK)	\$82.22	
11296	CORD ASSEMBLY (UK)	\$66.41	
11379	CORD ASSEMBLY, 18GA	\$39.83	
11538	WIRE ASM, 18GA, STRD, 200C, BLK, 4 IN	\$5.87	
11560	CORD ASSEMBLY (AUST)	\$77.51	
11566	CORD ASSEMBLY, 14GA	\$57.64	
11589	CORD ASSEMBLY, 14GA	\$38.76	
11599	CORD ASSEMBLY (BRAZIL)	\$77.51	
11600	CORD ASSEMBLY (BRAZIL)	\$77.51	
11601	CORD ASSEMBLY (BRAZIL)	\$77.51	
11603	WIRE ASM, 18GA, STRD, 250C, 9 IN	\$5.95	
11611	WIRE ASM, 18GA, STRD, 200C, GRN, 10 IN	\$4.87	
11615	CORD ASSEMBLY, 18GA	\$29.14	
11618	CORD ASSEMBLY, 18GA	\$47.20	
11619	CORD ASSEMBLY (CONT EURO)	\$64.35	
11621	CORD ASSEMBLY, 18GA	\$35.66	
11625	CORD ASSEMBLY (UK)	\$85.71	
11648	CORD ASSEMBLY, 18GA, 9'	\$54.31	
11652	CUT-OUT, THERMAL ASSY, PEPI, 152C	\$26.16	
11655	CORD ASSEMBLY, 18GA, 9'	\$58.00	
11657	BUSHING, STRAIN RELIEF, 18/3	\$1.16	
11658	CORD ASSEMBLY, 18GA	\$28.49	
11665	CORD ASSEMBLY, 18GA	\$25.50	
11676	CORD ASSEMBLY (AUST)	\$32.25	
11677	CORD ASSEMBLY (UK)	\$42.20	
11679	CORD ASSEMBLY (AUST)	\$34.42	
11681	CORD ASSEMBLY (UK)	\$44.32	
11682	CORD ASSEMBLY (CONT EURO)	\$77.51	
11684	CORD ASSEMBLY (UK)	\$77.51	
40179	LUBRICANT, FOOD EQUIPMENT	\$4.13	
40263	SWITCH, LIGHTED ROCKER, 125V	\$8.68	
55034	KIT, REPLACEMENT THERMOSTAT	\$55.16	
55053	KIT, REPLACEMENT THERMOSTAT	\$55.16	
55224	KIT, REPLACEMENT THERMOSTAT	\$55.16	
55266	KIT, REPLACEMENT THERMOSTAT	\$76.01	

item	description	list price	page
67028	KIT, SHROUD ASSY-SINGLE STAND	\$218.95	
67043	SHROUD ASSEMBLY	\$157.01	
67066	LID, FRONT LOCKABLE, CPSS-FL	\$139.52	
67067	KIT, SHROUD ASSY-SINGLE STAND, LOCK	\$178.86	
67207	BUSHING, STRAIN RELIEF, RT ANGLE	\$1.32	
67540	CONDIMENT PUMP CPSS-F	\$319.31	
67570	CONDIMENT PUMP CPSS-FL	\$366.98	
67580	SINGLE STAND ASSEMBLY	\$457.53	10
67590	SINGLE STAND ASSEMBLY (LOCKABLE)	\$508.36	10
67611	LID, CPSS-F	\$88.59	
67697	SHROUD ASSEMBLY, SINGLE STAND	\$179.27	
67699	KIT, SHROUD ASSY-SINGLE STAND, SE	\$221.20	
67703	KIT, SHROUD ASSY-TWIN STAND, SE	\$231.86	
67760	SINGLE STAND-SERVER EXPRESS	\$452.75	13
67859	TONGS, 6 1/2 IN, KOOL TOUCH	\$17.79	
67887	MB-4 SHORT W/(4)87202,(4)87253,(4)85156	\$573.48	
67890	MB-4 SHORT W/(4)87202 & (4)87253	\$451.17	
79890	SB-2 W/(2)82557 & (2)83330	\$988.11	36
80011	LID, CP-1/2R	\$128.09	
80030	FOUNTAIN PUMP FP-200-DI	\$287.53	18
80030-300	FOUNTAIN PUMP FP-200-DI, WHT	\$287.53	
80032	TUBE, DISCHARGE, FP-200, 14.5"	\$101.05	
80085	SHELF, TRIPLE, BEV STAT, INSWEETEN	\$166.80	61
80095	KIT, CLEANING BRUSHES & LUBE	\$17.95	
80101	SWEETSTATION, QUAD 24 OZ	\$698.99	61
80102	SWEETSTATION, QUAD 14 OZ	\$641.80	61
80103	SWEETSTATION, TRIPLE 24 OZ	\$548.07	61
80104	SWEETSTATION, TRIPLE 14 OZ	\$492.47	61
80107	DECAL SET (4), SWEETSTATION	\$12.63	
80160	SERVING BAR 2 JAR	\$379.68	38
80253	TUBE, DISCHARGE, CP-1/6, 14.5"	\$84.67	
80283	COLLAR, GAGING 1.953 IN(49.6MM)LG, PL	\$7.96	
80294	TUBE, DISCHARGE, FP-1/6	\$89.60	
80310	LID,HINGED ASSY, PLSTC,FOUNTAIN JAR	\$47.66	41
80314	LABEL, HAND WASH ONLY	\$2.45	
80443	LOCK, PUMP	\$25.81	41
80447	LOCK, PUMP 7 1/2 IN	\$26.22	
80674	COLLAR, GAGING-.063 OZ REDUCTION	\$5.05	
80840	FOOD SERVER SUPREME FSPW-SS (230V)	\$1,213.68	49
80844	FOOD SERVER FSPW-SS, NO JAR (230V)	\$1,104.08	
80871	SR-5S W/(5)82558 & (5)80310	\$683.09	
80878	LEVER, THICK PUMP	\$81.66	
80879	THICK PUMP W/LEVER TPV-L, 1/2 OZ	\$378.08	18, 39
80882	LID ASSEMBLY, TPV-L	\$47.21	
80961	LID, WIDE, BP, BLACK-PLASTIC	\$30.18	
80968	KIT, SUCTION TUBE CC	\$45.88	
80976	LOCK, LEVER PUMP	\$23.83	
80978	LEVER, SYRUP RAIL	\$81.66	
80988	TUBE, DISCHARGE, 8.5"	\$126.53	
80992	SUPPORT, POUCH	\$27.58	

## Server 2024 Price Guide (81000–82023-020)

item	description	list price	page
81000	FOOD SERVER FS-4 PLUS	\$617.97	44
81003	FUDGE SERVER FSP, NO JAR (230V)	\$745.06	
81005	LABEL, WARNING (ENGLISH/FRENCH)	\$1.74	
81006	LABEL, HOT	\$0.94	
81009	SHROUD ASSEMBLY	\$94.47	
81017	BRACKET, THERMOSTAT	\$3.48	
81031	INSET, 4 QT	\$82.60	
81034	THERMOSTAT, 66C	\$25.40	
81036	CUT-OUT,THERMAL ASSY,184C,10.24	\$13.90	
81037	CUT-OUT, THERMAL ASSY, 184C, 9.80 IN	\$12.75	
81039	SHROUD ASSEMBLY	\$71.57	
81040	KIT, REPL THERMO FS, FSP, FS-4 120V	\$92.82	
81045	SPRING, HINGE, KETTLE	\$16.07	
81050	INSET & LID ASSEMBLY, 4 QT	\$267.68	
81051	KIT, REPL HEATING ELEMENT-500W	\$118.83	
81055	KNOB, THERMOSTAT	\$12.63	
81058	FOOT, W/SCREW	\$3.90	
81061	INSET & SOCKET ASSEMBLY, 4 QT	\$111.04	
81066	INSET, 2 1/2 QT	\$74.67	
81068	KIT, REPL WATER VESSEL, COMPLETE	\$253.03	
81073	HINGE	\$8.94	
81075	SPRING, HINGE	\$15.73	
81087	KIT, REPL WATER VESSEL, COMPL 230V	\$277.01	
81088	GUARD, KNOB	\$10.27	
81096	LID ASSEMBLY, FS-4	\$155.75	
81105	PIN, COTTERLESS HINGE	\$5.30	
81108	INSET & SOCKET ASSEMBLY, 5 QT	\$111.04	
81111	INSET & LID ASSEMBLY, 5 QT	\$273.24	
81116	VESSEL, WATER ASSEMBLY, 4 QT	\$136.72	
81140	FOOD SERVER SUPREME FSPW-SS	\$1,077.07	49
81157	KIT, KNOB GUARD	\$21.85	
81165	CUT-OUT, THERMAL ASSY, 184C, 9.11 IN	\$12.17	
81169	FOOT, W/SCREW	\$1.82	
81177	PLATE, HEATER BAND	\$4.06	
81181	SUPPORT, POUCH, CAST ALUMINUM	\$149.79	
81184	KIT, FSP EXPRESS CONNECTION	\$235.18	
81185	FOOD SERVER PUMP, EXPRESS CONN	\$302.64	
81194	COVER, CONTROL W/LABEL-FSPW	\$79.44	
81196	FOOD SERVER PUMP, HEAVY SPRING	\$312.97	
81199	TWIN FOOD SERVER FS-4	\$1,169.21	
81200	TWIN FOOD SERVER FS-4 PLUS	\$1,169.21	45
81210	BASE ONLY FOR TWIN FS/FSP	\$765.70	
81219	SHROUD ASSEMBLY	\$294.80	
81220	TWIN FUDGE SERVER TWIN FS	\$986.52	47
81223	SHROUD ASSEMBLY	\$294.80	
81224	THERMOSTAT, 60C	\$23.51	
81230	TWIN FUDGE SERVER TWIN FSP	\$1,401.13	47
81231	CLOSER, BOTTOM	\$29.81	
81236	CUT-OUT, THERMAL, 167-169°C	\$28.15	
81237	CLOSER, BOTTOM	\$39.80	

item	description	list price	page
81260	TWIN FUDGE SERVER FSP (230V)	\$1,569.54	47
81262	LID, SLIM, BP, BLACK-PLASTIC	\$9.84	
81269	PLATE, TEMP INDICATOR, FS/FSP	\$10.27	
81271	KNOB, THERMOSTAT	\$7.05	
81273	PLATE, TEMPERATURE INDICATOR, FS-4	\$10.27	
81274	PLATE, TEMP INDICATOR, TWIN, FS-4	\$20.21	
81278	VESSEL, WATER ASSEMBLY	\$230.43	
81280	KIT, REPL THERMO TWIN UNITS 120V	\$105.83	
81290	TWIN FUDGE SERVER TWIN FS/FSP	\$1,199.39	47
81296	PLATE, TEMP INDICATOR, TWIN, FS/FSP	\$17.05	
81297	ELEMENT, HEATING, 120V 500W	\$97.72	
81298	ELEMENT, HEATING, 230V 500W	\$105.42	
81299	ELEMENT, HEATING, 120V 500W	\$143.09	
81320	FOOD SERVER PUMP	\$320.89	
81329	KNOB	\$4.13	
81349	KIT, REPL HEATING ELEMENT-500W 230V	\$144.16	
81351	CORD (CONT EURO)	\$80.24	
81352	CORD (AUST)	\$97.31	
81355	CORD (UK)	\$97.72	
81407	VESSEL, WATER ASSEMBLY, 2 QT	\$334.03	
81411	TRIM, GUARD	\$24.50	
81414	LID ASSEMBLY, DISHER, 1/9	\$85.78	34
81415	LID ASSEMBLY, DISHER, FOUNTAIN	\$85.78	41
81416	FOUNTAIN PUMP FP, COMPACT, DEEP	\$289.13	18
81417	TUBE, DISCH, FP COMPACT, 8.5", 10 IN	\$100.07	
81984	COLLAR, GAGING, 1.81 IN LG	\$10.43	
82000	SERVER PUMP SP	\$308.99	10
82013	PISTON, 6.308	\$24.59	
82015	WASHER, PLASTIC, 1 OZ	\$0.58	
82016	SPRING, 7 IN	\$2.69	
82017	TUBE, HEAD	\$13.24	
82018	INSERT, HEAD	\$2.40	
82021	COLLAR, LOCKING	\$18.46	
82022	COLLAR, GAGING-.25 OZ REDUCTION	\$1.57	
82023-000	KNOB-000-BLACK	\$11.41	
82023-001	KNOB-001-CHOCOLATE	\$11.41	
82023-004	KNOB-004-MOCHA	\$11.41	
82023-005	KNOB-005-GLOBAL	\$11.41	
82023-006	KNOB-006-CHOCOLAT	\$11.41	
82023-009	KNOB-009-HEATH	\$11.41	
82023-010	KNOB-010-BUTTERFINGER	\$11.41	
82023-011	KNOB-011-PEANUT BUTTER CUP	\$11.41	
82023-012	KNOB-012-OREO	\$11.41	
82023-013	KNOB-013-SNICKERS	\$11.41	
82023-014	KNOB-014-OREO CREAM	\$11.41	
82023-015	KNOB-015-FUDGE	\$11.41	
82023-016	KNOB-016-SALTED CARAMEL	\$11.41	
82023-017	KNOB-017-VANILLA	\$11.41	
82023-018	KNOB-018-COFFEE	\$11.41	
82023-020	KNOB-020-SMALL	\$11.41	



## Server 2024 Price Guide (82023-021 – 82085)

item	description	list price	page
82023-021	KNOB-021-LARGE	\$11.41	
82023-022	KNOB-022-DARK CHOCOLATE	\$11.41	
82023-024	KNOB-024-CARAMEL	\$11.41	
82023-025	KNOB-025-SIMPLE	\$11.41	
82023-099	CUSTOM KNOB, BLACK	\$11.41	
82023-100	KNOB-100-RED	\$11.41	
82023-101	KNOB-101-HOUSE MIX	\$11.41	
82023-104	KNOB-104-STRAWBERRY	\$11.41	
82023-105	KNOB-105-COCKTAIL	\$11.41	
82023-107	KNOB-107-CHOCOLATE	\$11.41	
82023-109	KNOB-109-FRUITS ROUGES	\$11.41	
82023-110	KNOB-110-BLUEBERRY	\$11.41	
82023-111	KNOB-111-PINEAPPLE	\$11.41	
82023-112	KNOB-112-CHERRY	\$11.41	
82023-113	KNOB-113-RASPBERRY	\$11.41	
82023-114	KNOB-114-NAARMANN	\$11.41	
82023-115	KNOB-115-LTO, RED VELVET	\$11.41	
82023-119	KNOB-119-PEANUT BUTTER	\$11.41	
82023-199	CUSTOM KNOB, RED	\$11.41	
82023-200	KNOB-200-YELLOW	\$11.41	
82023-202	KNOB-202-BUTTERSCOTCH	\$11.41	
82023-203	KNOB-203-CARAMEL	\$11.41	
82023-204	KNOB-204-HONEY MUSTARD	\$11.41	
82023-206	KNOB-206-PINEAPPLE	\$11.41	
82023-207	KNOB-207-SWEET & SOUR	\$11.41	
82023-211	KNOB-211-CHEESECAKE	\$11.41	
82023-212	KNOB-212-PROMO	\$11.41	
82023-217	KNOB-217-VANILLA	\$11.41	
82023-218	KNOB-218-DARK CARAMEL	\$11.41	
82023-299	CUSTOM KNOB, YELLOW	\$11.41	
82023-300	KNOB-300-WHITE	\$11.41	
82023-302	KNOB-302-CARAMEL	\$11.41	
82023-303	KNOB-303-CREAM	\$11.41	
82023-304	KNOB-304-CAESAR	\$11.41	
82023-305	KNOB-305-SKIM MILK	\$11.41	
82023-306	KNOB-306-MILK	\$11.41	
82023-307	KNOB-307-MAYONNAISE	\$11.41	
82023-308	KNOB-308-OREO	\$11.41	
82023-309	KNOB-309-RANCH	\$11.41	
82023-311	KNOB-311-VANILLA	\$11.41	
82023-314	KNOB-314-WHITE MOCHA	\$11.41	
82023-315	KNOB-315-MARSHMALLOW	\$11.41	
82023-316	KNOB-316-WHIPPED TOPPING	\$11.41	
82023-317	KNOB-317-WHITE CHOCOLATE	\$11.41	
82023-318	KNOB-318-SIMPLE	\$11.41	
82023-399	CUSTOM KNOB, WHITE	\$11.41	
82023-400	KNOB-400-BLUE	\$11.41	
82023-499	CUSTOM KNOB, BLUE	\$11.41	
82023-500	KNOB-500-GREEN	\$11.41	
82023-501	KNOB-501-COCKTAIL SAUCE	\$11.41	

item	description	list price	page
82023-503	KNOB-503-REMOULADE	\$11.41	
82023-504	KNOB-504-CHAI	\$11.41	
82023-506	KNOB-506-CREME DE MENTHE	\$11.41	
82023-599	CUSTOM KNOB, GREEN	\$11.41	
82023-700	KNOB-700-BROWN	\$11.41	
82023-702	KNOB-702-BBQ	\$11.41	
82023-703	KNOB-703-CHOCOLATE	\$11.41	
82023-704	KNOB-704-COCKTAIL SAUCE	\$11.41	
82023-705	KNOB-705-HOT FUDGE	\$11.41	
82023-707	KNOB-707-SHRIMP SAUCE	\$11.41	
82023-709	KNOB-709-HONEY MUSTARD	\$11.41	
82023-713	KNOB-713-BUTTERSCOTCH	\$11.41	
82023-714	KNOB-714-PIE PIECES	\$11.41	
82023-715	KNOB-715-BROWNIE PIECES	\$11.41	
82023-716	KNOB-716-CHOCO CHUNKS	\$11.41	
82023-717	KNOB-717-TRUFFLES	\$11.41	
82023-719	KNOB-719-CARAMEL FUDGE	\$11.41	
82023-720	KNOB-720-COOKIE DOUGH	\$11.41	
82023-721	KNOB-721-CHEESECAKE PIECES	\$11.41	
82023-722	KNOB-722-COCOA FUDGE	\$11.41	
82023-723	KNOB-723-MILK CHOCOLATE	\$11.41	
82023-724	KNOB-724-CHOCOLATE SHELL	\$11.41	
82023-725	KNOB-725-CHICKENJOY GRAVY	\$11.41	
82023-799	CUSTOM KNOB, BROWN	\$11.41	
82023-800	KNOB-800-ORANGE	\$11.41	
82023-804	KNOB-804-PUMPKIN SPICE	\$11.41	
82023-805	KNOB-805-MARASCHINO CHERRIES	\$11.41	
82023-806	KNOB-806-PEANUT BUTTER	\$11.41	
82023-899	CUSTOM KNOB, ORANGE	\$11.41	
82023-900	KNOB-900-GRAY	\$11.41	
82023-901	KNOB-901-LTO	\$11.41	
82023-999	CUSTOM KNOB, GRAY	\$11.41	
82027	NUT, DISCHARGE TUBE	\$5.14	
82036	LID, FP	\$41.31	
82037	LID, FP-V	\$41.31	
82049	BRUSH, 11 IN	\$3.90	
82054	PLUNGER ASSEMBLY SP	\$77.85	
82055	PLUNGER ASSEMBLY FP	\$93.43	
82057	PLUNGER ASSEMBLY CP-1/6	\$111.62	
82058	PLUNGER ASSEMBLY CP-200	\$98.04	
82059	SPACER, SS	\$14.38	
82060	FUDGE SERVER W/PUMP FSP	\$745.06	46
82061	LID, FSP	\$75.76	
82063	SPACER	\$8.58	
82066	BASE ONLY FOR FS & FSP	\$435.27	
82070	FOUNTAIN PUMP FP	\$296.29	18
82076	PISTON, 8.407	\$24.77	
82077	SPRING, 10 IN	\$2.78	
82078	TUBE, HEAD	\$14.98	
82085	PLUNGER ASSEMBLY, BLACK	\$63.79	

## Server 2024 Price Guide (82093 – 82725)

item	description	list price	page
82093	KIT, REPLACEMENT PARTS	\$95.97	
82098	LID, FPV-DI	\$41.31	
82100	FOUNTAIN PUMP FP-200	\$296.29	18
82106	COLLAR, LOCKING	\$34.89	
82110	FUDGE SERVER W/PUMP FSP (230V)	\$832.43	46
82120	FOUNTAIN PUMP FP-V VERTICAL	\$296.29	18, 40
82120-101	FOUNTAIN PUMP FP-V VERTICAL, 101	\$296.29	
82120-302	FOUNTAIN PUMP FP-V VERTICAL, 302	\$296.29	
82120-703	FOUNTAIN PUMP FP-V VERTICAL, 703	\$296.29	
82123	LID, CP-F	\$43.07	
82124	PLUNGER ASSEMBLY CP-200, WHITE	\$83.72	
82130	FOUNTAIN PUMP FP-200V	\$296.29	18, 40
82136	LID, FP-200 TALL	\$40.90	
82137	LID, FP-200	\$41.31	
82142	LID, FP-200V	\$41.31	
82145	LID, CP-200	\$43.07	
82152	LID, SP	\$83.13	
82153	LID, CP-10	\$83.13	
82209	SWITCH, LIGHTED ROCKER, 250V	\$31.31	
82229	KIT, O-RING (82323)	\$11.62	
82245	SCREW, HOLD DOWN	\$31.05	
82296	CYLINDER ASSEMBLY	\$54.01	
82311	PLUNGER ASSEMBLY, BLACK	\$57.26	
82312	PLUNGER ASSEMBLY, WHITE	\$57.26	
82319	BODY, VALVE ASSEMBLY	\$129.71	
82323	O-RING, 1 5/16 IN, SILICONE	\$1.37	
82336	CYLINDER ASSEMBLY	\$74.37	
82339	O-RING, 11/16 IN	\$1.08	
82341	TUBE, SUCTION, 1.56	\$8.80	
82348	CYLINDER ASSEMBLY	\$82.57	
82358	CYLINDER ASSEMBLY	\$71.70	
82362	CYLINDER ASSEMBLY	\$69.47	
82369	TUBE, DISCHARGE, CP-F, 8.5"	\$92.65	
82371	TUBE, DISCHARGE, CP-10	\$87.36	
82372	TUBE, DISCHARGE, CP-200, 14.5"	\$89.60	
82373	TUBE, DISCHARGE, CP-G & CP-3, 8.5"	\$89.18	
82374	TUBE, DISCHARGE, CP-6 1/2, CP-8 1/2	\$87.95	
82375	TUBE, DISCHARGE, CPSS-F, 8.5"	\$89.76	
82376	TUBE, DISCHARGE, CP-1/9 & CP-1/6	\$86.93	
82377	LID, CP-1/6	\$45.19	
82379	LID, CP-1/6, ROTATED	\$39.74	
82383	TUBE, SUCTION, 2.06	\$7.96	
82398	LID, CP-1/4	\$71.04	
82399	LID, CP-1/3	\$83.65	
82424	TUBE, DISCHARGE, COND SERVER, 14.5"	\$94.64	
82427	TUBE, DISCHARGE, CREAM SERVER 14.5"	\$108.81	
82431	KIT, REPL VALVE BODY ASSEMBLY	\$150.29	
82432	BODY, VALVE ASSEMBLY, EXTENDED	\$128.52	
82433	KIT, REPL EXTENDED VALVE ASSEMBLY	\$162.40	
82476	TUBE, DISCHARGE, FP & FP-1 1/2, 8.5"	\$99.11	

item	description	list price	page
82479	TUBE, DISCHARGE	\$54.01	
82483	TUBE, DISCHARGE, 14.5"	\$35.98	
82485	TUBE, DISCHARGE, FSP	\$96.71	
82487	TUBE, DISCHARGE, FP-V, 8.5"	\$96.96	
82489	TUBE, DISCHARGE, SP	\$95.48	
82491	LID	\$40.90	
82493	TUBE, DISCHARGE, BUTTER SERVER	\$116.66	
82495	TUBE, DISCHARGE, FP-DI SLIM, 8.5"	\$113.09	
82497	TUBE, DISCHARGE, FP-200, 14.5"	\$96.71	
82499	TUBE, DISCHARGE, FP-200V, 14.5"	\$97.38	
82500	FUDGE SERVER FS	\$548.07	46
82507	ADAPTER	\$68.50	
82509	LID ASSEMBLY, FS	\$77.05	
82515	TUBE, DISCHARGE, FPV-DI, 8.5"	\$216.28	
82520	FOUNTAIN PUMP FPV-DI	\$330.43	18, 40
82526	BRUSH, 21 IN	\$9.84	
82533	KIT, SPARE PARTS SERVER-CAST	\$18.39	
82545	LID, HINGED ASSEMBLY, SS	\$56.25	41
82545-100	LID, HINGED ASSEMBLY, SS-RED	\$56.25	
82550	SYRUP RAIL 4 JAR-10 IN	\$325.67	38, 41
82557	JAR, FOUNTAIN, PLASTIC, DEEP, WHITE	\$20.17	
82558	JAR, FOUNTAIN, PLASTIC, SHALLOW, WHITE	\$20.17	39
82559	LID ASSEMBLY, SS W/KNOB	\$31.78	41
82561	LADLE, 10 IN, 1 OZ	\$21.84	40
82562	LADLE, 7 IN, 1 OZ	\$21.84	40
82570	SYRUP RAIL 2 JAR	\$246.23	38
82574	LADLE, 4 OZ	\$25.02	
82595	LID & LADLE ASSEMBLY, 7 IN, 1 OZ	\$75.48	
82600	SYRUP RAIL 3 JAR-10 IN	\$273.24	38
82632	JAR, HOLD COLD, FOUNTAIN, BLACK	\$203.34	
82633	JAR, HOLD COLD, FOUNTAIN, WHITE	\$203.34	
82633-HOLES	JAR, HOLD COLD, FOUNTAIN, WHITE	\$203.34	
82635	BODY, VALVE ASSEMBLY, CONNECTOR	\$113.98	
82637	TUBE, DISCHARGE, CP-200 EX CON 15.2"	\$112.04	
82638	LID, CPEC	\$41.31	
82643	TUBE, DISCHARGE, FP-200V EX CONN	\$129.66	
82644	LID, FPEC	\$41.31	
82660	LADLE, 2 OZ	\$20.24	
82661	LADLE, 6 OZ	\$25.81	
82662	LADLE, 8 OZ	\$31.38	
82664	TUBE, DISCHARGE, CP-F EX CONN, 8.5"	\$92.50	
82665	CYLINDER ASSEMBLY	\$147.39	
82666	LID, CPEC CP-F	\$43.07	
82700	FOOD SERVER FS-2	\$575.07	54
82706	LID ASSEMBLY, FS-2	\$52.83	
82707	BOWL, SS, FS-2	\$83.65	
82710	FOOD SERVER FS-2 (230V)	\$616.37	54
82717	LADLE, 4 IN, 1 OZ	\$22.64	
82717-RED	LADLE, 4 IN, 1 OZ	\$22.89	
82725	SPRING, 11 IN	\$6.52	



## Server 2024 Price Guide (82740–83553)

item	description	list price	page
82740	FOUNTAIN PUMP EX CONN, FP-200V	\$311.36	12
82740-315	FOUNTAIN PUMP EX CONN, FP-200V, 315	\$311.36	
82776	SHROUD ASSEMBLY, FS-2, 120V	\$72.41	
82786	SHROUD ASSEMBLY, FS-2, 230V	\$221.73	
82800	FOUNTAIN PUMP EXPRESS CONN, FP-200	\$308.19	12
82806	TUBE, DISCHARGE, FP-200 EX CONN	\$122.23	
82808	LID, FPEC FP-200	\$41.31	
82824	BRUSH, 15 IN, 13/32 & 3/16	\$14.23	
82830	SR-4 W/(4)82557 & (4)82120	\$1,566.36	36
82846	KIT, HOLD COLD CAN COOLER, BLACK	\$281.18	
82866	COLLAR, GAGING, 1.710 IN (43.4MM) LG	\$10.25	
82869	KIT, GAGING COLLAR, 50/CASE	\$78.68	
82870	SR-3 W/(3)82557 & (3)82120	\$1,208.93	36
82898	KIT, PUMP REBUILD 7 IN & 10 IN	\$51.32	
82910	SR-2 W/(2)82557 & (2)82120	\$868.96	36
82952	LID, FP-200	\$37.82	
82954	LADLE SLIM, 7 IN, 1/2 OZ	\$21.84	
82957	LID, FP-200 RED	\$37.82	
82976	LADLE SLIM, 10 IN, 1 OZ	\$21.84	40, 41
82977	LADLE SLIM, 7 IN, 1 OZ	\$21.84	40
82990	FOUNTAIN PUMP FP-DI	\$330.43	18
83000	CONDIMENT PUMP CP-10	\$308.99	10
83003	SEAL ASSEMBLY, MACHINED	\$5.08	
83005	SEAL	\$5.00	
83014	KIT, SPARE PARTS W/PISTON-CAST	\$55.37	
83017	TUBE, DISCHARGE, CP-10 SPECIAL 1/2 IN	\$102.59	
83062	KIT, PUMP REBUILD, 7 IN W/GASKET	\$49.36	
83074	TUBE, DISCHARGE, FP-1/9, 14.5°	\$120.81	
83092	LID, EZT CARAMEL	\$35.18	
83093	LID, EZT HOT FUDGE	\$35.18	
83102	LID, 120MM, STAINLESS	\$89.93	
83103	LID, 110MM, STAINLESS	\$78.17	
83110	CONDIMENT PUMP CP-G 120MM	\$325.67	10
83117	FOUNTAIN PUMP EZT, CARAMEL	\$285.95	
83118	FOUNTAIN PUMP EZT, HOT FUDGE	\$285.95	
83120	CONDIMENT PUMP CP-G 110MM	\$325.67	10
83122	JAR, PLASTIC, 110MM	\$12.02	
83130	CONDIMENT PUMP CP-G 89MM	\$325.67	10
83141-001	FOUNTAIN PUMP EX CONN, FP-200-DI, 001	\$320.89	
83142	TUBE, DISCHARGE, FP-200-DI, 14.5°	\$113.09	
83147	JAR, FOUNTAIN, PLASTIC, SHALLOW, BLACK	\$27.00	39
83148	JAR, FOUNTAIN, PLASTIC, SHALLOW, ORANGE	\$27.00	39
83149	JAR, FOUNTAIN, PLASTIC, DEEP, BLACK	\$27.00	39
83156	JAR, FOUNTAIN, PLASTIC, DEEP, ORANGE	\$27.00	39
83157	JAR, FOUNTAIN, PLASTIC, SLIM, SHALLOW, BLACK	\$27.00	39
83158	JAR, FOUNTAIN, PLASTIC, SLIM, SHALLOW, ORANGE	\$27.00	39

item	description	list price	page
83159	JAR, FOUNTAIN, PLASTIC, SLIM, DEEP, BLACK	\$27.00	39
83162	JAR, FOUNTAIN, PLASTIC, SLIM, DEEP, ORANGE	\$27.00	39
83181	JAR, FOUNTAIN, PLASTIC, SLIM, SHALLOW, WHITE	\$20.17	39
83182	JAR, FOUNTAIN, PLASTIC, SLIM, DEEP, WHITE	\$20.17	39, 41
83184	LID, HINGED ASSEMBLY, SLIM	\$56.25	41
83187	LID, FP-V SLIM	\$41.31	
83188	LID, FP-200V SLIM	\$41.31	
83189	LID ASSEMBLY, SLIM	\$33.36	41
83192	LID, FP-200 SLIM	\$41.31	
83195	LID, CP-F SLIM	\$43.07	
83200	CONDIMENT PUMP CP-6 1/2	\$293.89	20
83201	LID, CP-6 1/2	\$59.46	
83214	LID, HINGED ASSEMBLY, PLSTC, SLIM	\$47.66	41
83215	KIT, SLIM CONVERSION-DEEP	\$135.04	
83216	KIT, SLIM CONVERSION-SHALLOW	\$135.04	
83220	CONDIMENT PUMP CP-8 1/2	\$311.36	20
83221	LID, CP-8 1/2	\$72.38	
83235	COLLAR, GAGING, 2/3 FL OZ	\$8.11	
83240	CONDIMENT PUMP CP-10 1/2	\$360.62	20
83241	LID, CP-10 1/2	\$144.57	
83248	LABEL, WARNING (ARABIC)	\$10.39	
83300	CONDIMENT PUMP CP-200	\$296.29	18, 40
83330	CONDIMENT PUMP CP-F	\$296.29	18, 40
83376	LID, FP-200 1/2 OZ SLIM	\$56.21	
83398	PISTON & SEAL ASSEMBLY 8.407	\$29.86	
83400	CONDIMENT PUMP CP-1/6	\$299.47	16
83400-200	CONDIMENT PUMP CP-1/6, YELLOW	\$299.47	
83412	COLLAR, LOCKING	\$47.69	
83415	COLLAR, GAGING-.33 OZ REDUCTION	\$11.41	
83416	COLLAR, GAGING, .95 IN(24.1MM) LG	\$10.34	
83420	CONDIMENT PUMP CP-1/4	\$314.53	16
83425	HANDLE	\$54.89	
83430	CONDIMENT PUMP CP-1/3	\$325.67	16
83431	TUBE, DISCH, CP-1/9 & CP-1/6 TALL	\$114.12	
83432	LID, CP-1/6 TALL	\$47.37	
83433	CONDIMENT PUMP CP-1/6, TALL	\$316.13	16
83439	LID, CP-1/3 TALL	\$83.65	
83441	CONDIMENT PUMP CP-1/3, TALL	\$343.94	16
83497	TUBE, DISCHARGE, FP-1/6 TALL, 14.5°	\$102.03	
83529	COLLAR, GAGING-.125 OZ REDUCTION	\$1.57	
83541	FOUNTAIN EXPRESS TWIN, 96 OZ	\$880.08	
83544	SHROUD ASSEMBLY	\$120.09	
83546	DIVIDER ASSEMBLY	\$65.17	
83547	RAMP	\$18.79	
83548	LID, SYRUP POUCH PUMP	\$52.83	
83551	TUBE, DISCHARGE, SYRUP POUCH PUMP	\$89.26	
83553	SYRUP POUCH PUMP, SS	\$328.05	

## Server 2024 Price Guide (83558–85474)

item	description	list price	page
83558	SIGN HOLDER	\$48.69	
83565	TUBE, HEAD, 1/2 OZ	\$13.24	
83600	SERVING BAR 4 JAR	\$446.39	39
83620	SERVING BAR 4 JAR DROP-IN	\$521.06	39
83697	FOOD SERVER SUPREME FSPW-SS (UK)	\$1,213.68	49
83700	SB-4 W/(4)82557 & (4)83330	\$1,702.96	36
83720	SB-4DI W/(4)82557 & (4)83330	\$1,756.98	36
83751	KIT, GAGING COLLAR, 4/BAG, CASE	\$6.30	
83760	SERVING BAR 3 JAR	\$413.04	38
83790	SB-3 W/(3)82557 & (3)83330	\$1,351.90	36
83807	KNOB	\$6.22	
83830	SERVING BAR 3 JAR DROP-IN	\$465.46	38
83832	LID, CP-5.5L	\$90.00	
83860	SB-3DI W/(3)82557 & (3)83330	\$1,409.09	36
83910	CONDIMENT PUMP CP-8 1/2L	\$406.68	20
83912	LID ASSEMBLY, CP-8 1/2L	\$200.88	
83920	CONDIMENT PUMP CP-5	\$293.89	20
83921	LID, CP-5	\$90.00	
84000	FOOD SERVER FS-7	\$1,119.96	44
84003	INSULATOR, VESSEL	\$5.14	
84004	INSULATOR, BOX	\$5.78	
84017	THERMOSTAT, 79C	\$248.43	
84022	KNOB, THERMOSTAT	\$22.04	
84031	INSET, 7 QT	\$95.33	
84035	KIT, REPL CUT-OUT FS-7 & FS-11	\$107.40	
84040	INSET & LID ASSEMBLY, FS-7	\$363.80	
84043	INSET & SOCKET ASSEMBLY	\$210.57	
84053	LID ASSEMBLY, FS-7 COMPLETE	\$232.01	
84056	VESSEL, WATER ASSEMBLY	\$378.33	
84070	KIT, REPL HEATING ELEMENT-1000W	\$277.23	
84080	KIT, REPL HEATING ELEMENT-1500W	\$224.83	
84090	SYRUP RAIL 1 JAR	\$193.81	38
84100	FOOD SERVER FS-11	\$1,142.21	44
84128	VESSEL, WATER ASSEMBLY	\$473.89	
84131	INSET, 11 QT	\$98.50	
84143	INSET & SOCKET ASSEMBLY	\$178.78	
84144	LID ASSEMBLY, FS-11 COMPLETE	\$232.01	
84149	INSET & LID ASSEMBLY, FS-11	\$427.34	
84190	SYRUP SERVER 3 GAL	\$1,083.42	57
84199	LID ASSEMBLY, SYRUP SERVER 3 GAL	\$114.53	
84216	KIT, SPARE PARTS SYRUP SERVER	\$18.65	
84217	WASHER, RUBBER, BEVELED	\$3.98	
84257	BRUSH, 21 IN X 1/2	\$10.65	
84258	LID, FP SLIM THIN	\$41.31	
84259	LID, FP SLIM THICK	\$41.31	
84271	TUBE, HEAD 1/2 PUMP	\$14.07	
84273	TUBE, DISCHARGE, THICK (SLIM) 8.5°	\$114.28	
84275	TUBE, DISCHARGE, THIN (SLIM) 8.5°	\$103.41	
84303	VESSEL, WATER ASSEMBLY	\$408.98	
84354	KIT, REPL HEATING ELEMENT-1500W KS	\$225.48	

item	description	list price	page
84357	KIT, REPL WATER VESSEL KS	\$523.33	
84384	LIGHT, INDICATOR ASSEMBLY	\$20.88	
84393	FOOT, RUBBER	\$1.32	
84398	LADLE, 4 OZ, KOOL TOUCH	\$32.56	
84409	CAP, KETTLE LEG	\$1.66	
84437	INSET, KETTLE, 11 QT	\$212.87	
84452	LID ASSEMBLY, KETTLE SERVER	\$252.59	
84462	INSET, KETTLE, 7 QT	\$208.12	
84485	PLACARD, MAGNETIC	\$7.46	
84580	FUDGE SERVER W/PUMP FSP (UK)	\$832.43	46
84972	DECAL SET, MAGNETIC, EZT SGL TALL	\$30.39	
84974	DECAL, MAGNETIC, EZT TWIN TALL	\$30.39	
84975	DECAL, MAGNETIC, EZT TWIN SHORT	\$30.39	
84990	TWIN FUDGE SERVER TWIN FSP (UK)	\$1,569.54	47
84999	THERMOSTAT, 58 IN, 93°C	\$123.39	
85001	VESSEL, FOOD ASSEMBLY	\$795.93	
85004	LID, ADVANTAGE	\$105.42	
85005	TOP	\$72.12	
85008	SHROUD ASSEMBLY	\$204.28	
85038	BODY, VALVE ASSEMBLY, 90° CONNECTOR	\$150.74	
85042	LID, ADVANTAGE PUMP	\$25.83	
85050	FUDGE PUMP SERVER ADVANTAGE	\$285.95	
85065	TUBE, DISCHARGE, ADVANTAGE	\$77.92	
85070	FOOD SERVER ADVANTAGE, FUDGE & CARM	\$1,539.31	
85083	CAP, PUMP	\$1.75	
85084	KNOB, THERMOSTAT	\$11.83	
85108	DECAL SET, ADVANTAGE, MAGNETIC	\$19.86	
85111	ELEMENT, HEATING, 120V 350W	\$118.58	
85113	KIT, REPL THERMAL CUT-OUT, FSA	\$44.13	
85150	RELISH SERV 2 PAN	\$320.89	
85151	PAN, 1 QT, 4 IN DEEP	\$34.71	
85156	SPOON, 1/2 OZ	\$12.55	35
85160	RELISH SERV 2 PAN W/SELF CLOSE LID	\$320.89	
85161	LID, STORAGE, RELISH SERVER	\$20.24	
85176	BRACKET, THERMOSTAT BULB	\$31.39	
85206	BRUSH, 52 IN	\$15.73	
85248	O-RING, 1 3/16 IN	\$6.87	
85255	HOSE, 36 IN	\$149.06	
85264	CONNECTOR, ADAPTER, 16MM	\$22.41	
85300	FOUNTAIN PUMP FP-V, SLIM	\$296.29	
85310	FOUNTAIN PUMP FP-200V, SLIM	\$296.29	19, 40
85340	CONDIMENT PUMP CP-F, SLIM	\$296.29	19, 40
85350	FOUNTAIN PUMP FP-200, SLIM	\$296.29	19
85426	LABEL, LOGO, 2 X .5	\$2.06	
85455	TUBE, DISCHARGE, TP-V, 8.5° THICK	\$114.64	
85458	LID, TP-V THICK	\$41.31	
85459	TUBE, DISCHARGE, TP-200V, 14.5° THICK	\$114.64	
85463	LID, TP-200V THICK	\$41.31	
85473	LID ASSEMBLY, SYRUP SERVER 1.5 GAL	\$98.96	
85474	VESSEL, SYRUP (T304), 1 1/2 GAL	\$92.94	



## Server 2024 Price Guide (85479–86793)

item	description	list price	page
85479	BRACKET, THERMOSTAT	\$24.19	
85480	SYRUP SERVER 1 1/2 GAL	\$722.82	57
85484	ELEMENT, HEATING, 120V 350W	\$97.64	
85485	LOCK, THERMOSTAT	\$28.49	
85487	KIT, FAUCET ASSEMBLY	\$73.61	
85488	NUT, JAM, PLASTIC	\$3.56	
85561	WHIPPED TOPPING CAN HOLDER, 1/6	\$108.43	
85566	WHIPPED TOPPING CAN HOLDER, 1/9	\$94.53	
85674	ELEMENT, HEATING, 120V 200W	\$67.36	
85681	GASKET, VESSEL, BOTTOM	\$19.00	
85684	ELEMENT, HEATING, 120V 150W	\$62.44	
85686	VESSEL ASSY, ALUMINUM, 9 1/2 IN DEEP	\$73.31	
85708	VESSEL ASSY, ALUMINUM, 6 IN DEEP	\$57.43	
85754	CAP, DISPENSING	\$30.58	
85758	HOSE ASSEMBLY, 36 IN	\$261.67	
85783	REMOTE PUMP SGL POUCH, 36 IN	\$813.37	15
85790	EZ TOPPER, TALL, SINGLE W/HB	\$1,007.18	51
85791	REMOTE BRACKET-COUNTERTOP	\$115.97	
85819	SUPPORT, POUCH	\$52.72	
85820	FOUNTAIN PUMP EZT	\$285.95	
85827	TUBE, DISCHARGE, EZ TOPPER	\$71.79	
85829	LID, EZT	\$34.61	
85846	KIT, EZ TOPPER	\$64.96	
85870	EZ TOPPER, TALL, TWIN WO/HB	\$1,390.03	
85872	FITTING, BARBED TEE	\$30.96	
85877	CLAMP, TURN-KEY	\$19.87	
85891	BODY, VALVE ASSEMBLY, CONNECTOR	\$162.04	
85899	EZ TOPPER, TALL, TWIN W/HB	\$1,509.16	51
85900	TRIPLE FOOD SERVER FS-4 PLUS	\$1,696.62	45
85901	SHROUD ASSEMBLY	\$447.66	
85903	CLOSER, BOTTOM	\$61.96	
85905	LABEL, LOGO, 2 X 1.29	\$2.31	
85912	KIT, REPL HEATING ELEMENT-500W	\$123.55	
85920	EZ TOPPER, SHORT, TWIN W/HB	\$1,421.79	51
85921	KIT, HOSE, 36 IN VOLUME TWIN PUMP	\$423.96	
85923	KIT, REPL THERMAL CUT-OUT, EZT	\$26.41	
85951	CP REMOTE PUMPING, TALL, SHORT CYL	\$352.67	
85953	LID, REMOTE, TALL	\$29.97	
86090	INTELLISERV, 1/3	\$835.59	56
86148	BASIN, PLASTIC, INTELLISERV	\$156.00	
86149	ELEMENT, HEATING, 120V 500W	\$92.39	
86189	BLOCK, TERMINAL	\$6.70	
86218	CUT-OUT, THERMAL, 128C	\$17.21	
86242	KNOB, THERMOSTAT	\$13.17	
86274	CONTROLLER, TEMPERATURE	\$228.54	
86275	THERMISTOR ASSEMBLY, INTELLISERV	\$29.97	
86276	ELEMENT, HEATING, 230V 500W	\$63.17	
86301	CLAMP, CABLE	\$0.66	
86302	SHROUD ASSEMBLY	\$176.97	
86305	LABEL, DIGITAL, ENGLISH	\$28.49	

item	description	list price	page
86307	CLOSER, BOTTOM	\$15.16	
86308	BRACKET, THERMISTOR	\$19.37	
86309	CUT-OUT, THERMAL ASSY, 184C, 14.51 IN	\$19.53	
86311	PLATE, HEAT, INTELLISERV	\$153.38	
86312	FOUNTAIN PUMP FP-1/6	\$299.47	16
86313	LID, FP-1/6	\$45.19	
86314	TUBE, DISCHARGE, FP-1/6, 14.5"	\$86.93	
86337	CAP, PROTECTIVE, .125 X .500	\$0.49	
86338	INTELLISERV, 1/3 (230V)	\$973.82	56
86341	INTELLISERV, 1/3 (UK)	\$973.82	56
86346	COLLAR, GAGING 2.150 IN, 5/16OZ, PLSTC	\$8.27	
86426	PUMP ACCESSORIES, 1 OZ	\$32.46	
86427	PUMP ACCESSORIES, 2 OZ	\$51.76	
86429	COLLAR, GAGING-1/6 OZ REDUCTION, PL	\$8.27	
86481	INTELLISERV, 1/3 (CANADA)	\$783.19	
86483	LABEL, DIGITAL, ENGLISH/FRENCH	\$16.34	19, 40, 41
86485	LABEL, DIGITAL, BRAZIL	\$21.61	
86486	LABEL, HOT (ENGLISH/FRENCH)	\$4.57	
86488	LABEL, WARNING (PORTUGUESE)	\$6.16	
86491	CUT-OUT, THERMAL, 150C	\$161.62	
86493	SWITCH, LIGHTED ROCKER, 250V	\$34.36	
86495	LABEL, HOT (PORTUGUESE)	\$4.57	
86540	BUTTER SERVER SUPREME BSW-SS	\$1,175.57	49
86619	HANDLE, PLASTIC	\$20.01	
86650	DRY PRODUCT DISPENSER-1 LITER, TPL	\$627.50	62
86660	DRY PRODUCT DISPENSER-2 LITER, TPL	\$657.69	62
86663	KIT, FREE-FLOW, 1 LITER	\$82.60	
86670	DRY PRODUCT DISPENSER-1 LITER, SGL	\$260.52	62
86680	DRY PRODUCT DISPENSER-2 LITER, SGL	\$268.48	62
86681	BODY, 1 LITER	\$49.89	
86682	BODY, 2 LITER	\$60.68	
86683	CYLINDER	\$35.96	
86684	PLUG, PORTION	\$6.55	
86688	LID, DRY PRODUCT DISPENSER	\$56.40	
86689	TUBE, PLASTIC	\$14.07	
86691	SCREW, THUMB, 10-32 X 3/4	\$5.05	
86749	DECAL SET, FSPW, MAGNETIC	\$19.86	
86750	FOUNTAIN PUMP TP-200V	\$312.17	18, 40
86760	FOUNTAIN PUMP TP-V	\$312.17	18, 40
86761	KIT, REPL HEATING ELEMENT-500W	\$106.91	
86763	KIT, REPL HEATER BLOCK ASSY, SS120V	\$369.89	
86766	CUT-OUT, THERMAL ASSY, 128C, 8.82 IN	\$26.24	
86768	SHROUD ASSEMBLY	\$98.72	
86769	LABEL, LOGO, SUPREME FSPW-SS, 120V	\$18.20	
86771	BASE, FS-4SS	\$60.77	
86773	TOP, FSPW-SS	\$52.18	
86774	BASE, FS-4SS, 230V	\$54.65	
86785	VESSEL, WATER ASSEMBLY, 4 QT	\$149.48	
86791	DECAL, BUTTER, MAGNETIC	\$19.86	
86793	GUARD, KNOB	\$11.76	

## Server 2024 Price Guide (86796–87530)

item	description	list price	page
86796	SHROUD ASSEMBLY	\$117.58	
86797	LABEL, LOGO, SUPREME FSPW-SS, 230V	\$27.65	
86807	KIT, REPL HEATER BLOCK ASSY, SS230V	\$375.68	
86809	BOTTLE, SQUEEZE, HEATED APPLICATION	\$19.62	
86810	SIGNATURE TOUCH SBW	\$570.31	46
86811	BOTTLE SUPPORT ASSEMBLY	\$163.63	
86818	BOTTLE, SQUEEZE, COLD APPLICATION	\$7.54	
86819	KIT, BOTTLE SUPPORT	\$230.20	
86826	SQUEEZE BTL HLDR 1/6, 2.88D DOUBLE	\$84.19	
86827	SQUEEZE BTL HLDR 1/6, 2.88D TRIPLE	\$85.00	
86829	SBH-1/6, 2.88 DIA, W/86818, DOUBLE	\$117.55	26
86831	SBH-1/6, 2.88 DIA, W/86818, TRIPLE	\$120.73	26
86899	THERMOSTAT, 15 IN, 93C	\$112.78	
86925	SIGNATURE TOUCH SBW (UK)	\$606.84	46
86934	SWITCH, SNAP-IN ROCKER, 250V	\$14.84	
86935	SHROUD ASSEMBLY	\$122.51	
86936	CONTROLLER, TEMPERATURE	\$244.64	
86941	BUTTER SERVER SUPREME (BRAZIL)	\$1,229.58	
86949	GASKET, INTELLISERV	\$53.41	
86974	SBH-1/3, 2.90 DIA, W/86818, OCTUPLE	\$152.52	26
86975	SQUEEZE BTL HLDR 1/3, 2.90D OCTUPLE	\$98.50	
86982	SQUEEZE BTL HOLDER, 2.63D OCTUPLE	\$116.50	
86983	SBH-1/3, 2.63 DIA, (FIFO), OCTUPLE	\$114.38	
86985	SQUEEZE BTL HLDR 1/3, 2.63D OCTUPLE	\$114.38	
86989	BOTTLE, SQUEEZE, 16 OZ, FIFO	\$9.44	
86994	SBH-1/6, 2.52 DIA, W/86989, QUAD	\$108.03	26
86996	SBH-1/3, 2.63 DIA, W/86989, OCTUPLE	\$171.56	26
87028	CAP, PLASTIC, 38MM W/LINER	\$0.49	
87045	SBH-1/3, 2.88 DIA, W/86818, SEXTUPLE	\$142.97	26
87090	INSEASON, DROP 1/CNT, AMBER	\$95.33	61
87091	LID, INSEASON, AMBER	\$19.78	
87092	BODY, INSEASON, AMBER	\$40.12	
87095	PLATE, CLOSER	\$9.13	
87096	SPREADER, WIDE DROP, AMBER	\$19.78	
87100	INSEASON, SPREAD 1/CNT, AMBER	\$95.33	61
87102	SPREADER, 4 IN DIA DROP, AMBER	\$19.78	
87126	TRIGGER ASSEMBLY, 1/2 TSP, GREEN	\$8.58	
87127	TRIGGER ASSEMBLY, 1/3 TSP, BLUE	\$8.58	
87128	TRIGGER ASSEMBLY, 1/4 TSP, BLACK	\$8.58	
87129	TRIGGER ASSEMBLY, .025 OZ, WHITE	\$8.58	
87131	TRIGGER ASSEMBLY, 1/8 TSP, BURGUNDY	\$8.58	
87132	TRIGGER ASSEMBLY, 1/16 TSP, TAN	\$8.58	
87135	SHELF, QUAD, BEV STAT, INSWEETEN	\$190.63	61
87156	SPREADER, CENTER DROP	\$23.43	
87157	INSWEETEN, 14OZ, .7 TSP, 1/CTN, WHT	\$135.04	
87162	BODY, INS, 24 FL OZ	\$73.87	
87163	BODY, INS, 14 FL OZ	\$65.54	
87174	TRIGGER ASSEMBLY, 1 TSP, GRN, INSWEETEN	\$16.68	
87176	TRIGGER ASSEMBLY, .7 TSP, WHT, INSWEETEN	\$16.68	

item	description	list price	page
87177	TRIGGER ASSEMBLY, 1/2 TSP, WHT, INSWEETEN	\$16.68	
87178	TRIGGER ASSEMBLY, .31 TSP, BLU, INSWEETEN	\$16.68	
87179	TRIGGER ASSEMBLY, .31 TSP, PINK, INSWEETEN	\$16.68	
87181	TRIGGER ASSEMBLY, .31 TSP, YEL, INSWEETEN	\$16.68	
87182	INSWEETEN, 24 OZ, .31 TSP, 1/CTN	\$155.68	
87188	INSWEETEN, 14 OZ, .31 TSP, 1/CTN	\$141.38	
87194	JAR, 1/9 SIZE, 3.50 IN DEEP, ORANGE	\$14.30	34
87195	JAR, 1/9 SIZE, 6 IN DEEP, ORANGE	\$15.11	34
87196	PLATE, ADAPTER, 1/9 SIZE JAR	\$17.48	
87198	JAR, 1/9 SIZE, 6 IN DEEP, CLEAR	\$18.65	
87199	JAR, 1/9 SIZE, 6 IN DP, WALL MT, CLR	\$15.11	
87202	JAR, 1/9 SIZE, 3.50 IN DEEP, BLACK	\$10.72	34
87203	JAR, 1/9 SIZE, 6 IN DEEP, BLACK	\$11.53	34
87211	LID, HINGED ASSEMBLY, 1/9 SIZE	\$51.64	34
87213	LADLE, 6 IN, 1 OZ	\$22.64	34, 56
87216	BRACKET, MOUNTING ASSEMBLY, SINGLE	\$72.19	
87217	BRACKET, MOUNTING ASSEMBLY, DOUBLE	\$89.76	34
87218	BRACKET, MOUNTING ASSEMBLY, TRIPLE	\$108.34	
87228	JAR & LID ASSEMBLY, MINI 3 1/2 IN	\$62.36	
87229	JAR & LID ASSEMBLY, MINI 6 IN	\$63.14	
87234	BAR, STRIKE	\$8.73	34
87246	LID, CP-1/9	\$25.60	
87247	LID, FP-1/9	\$25.40	
87253	LID, HINGED ASSY, PLASTIC, 1/9 SIZE	\$47.66	34
87257	LID, PLSTC, 1/9 SIZE, ORANGE KNOB	\$46.06	
87262	SPOON, 1/8 CUP	\$22.52	
87263	TRAY, CATCH	\$132.01	
87280	MINI BAR 3 JAR	\$326.73	33, 35
87282	PORTION SHAKER, ATTACHMENT	\$23.83	61
87297	TRIGGER ASSEMBLY .115 TSP, WHITE	\$8.58	
87300	CONDIMENT PUMP CP-1/9	\$285.95	16, 35
87300-100	CONDIMENT PUMP CP-1/9, RED	\$279.59	
87300-200	CONDIMENT PUMP CP-1/9, YELLOW	\$279.59	
87310	FOUNTAIN PUMP FP-1/9	\$285.95	16, 35
87312	RACK & 1/9 SIZE JAR ASSEMBLY	\$305.64	
87327	VESSEL, BATTER ASSEMBLY	\$505.57	
87328	COVER, DRIP TRAY	\$16.36	
87329	TRAY, DRIP, BATTER	\$51.16	
87337	FAUCET, SILVER	\$61.31	
87338	LID, THICK FOOD DISPENSER	\$52.34	
87339	CAP, PROTECTIVE, .125 X .250	\$0.70	
87340	MB-3 W/86974 & (4)100515	\$505.17	26
87360	MB-3 W/86996 & (4)100515	\$517.88	26
87460	MINI BAR 4 JAR	\$266.87	33
87480	MB-4 W/(4)87203,(4)87253,(4)85156	\$538.54	32
87510	SERVING BAR 1 JAR	\$1,057.43	38
87520	SERVING BAR 1 JAR DROP-IN	\$395.56	
87530	SBH-1/6, 2.56 DIA, W/86809, TRIPLE	\$155.68	26, 56



## Server 2024 Price Guide (87535–88166)

item	description	list price	page
87535	SQUEEZE BTL HLDR 1/6, 2.88D TRIPLE	\$73.07	
87548	CAP, PLASTIC, 38MM X .600, 1.156, BLU	\$4.12	
87549	CAP, PLASTIC, 38MM X .600, 1.156, BLK	\$4.12	
87551	STAND, DPD, SINGLE W/BACKET	\$260.52	
87552	STAND, DPD, DOUBLE W/BACKET	\$295.49	
87576	MB-2 COMBO (COMPACT SERVING STATION)	\$1,359.39	
87590	MINI BAR 4 JAR, SHORT	\$252.59	
87591	CONDIMENT PUMP 15 LITER BUCKET, 2 OZ	\$480.11	
87592	LID, CP-15L BUCKET	\$80.16	
87593	TUBE, DISCHARGE, CP-15L, 8.5"	\$114.58	
87594	TUBE, PLASTIC, 4 1/2 IN	\$16.29	
87601	COLLAR, LOCKING, 2 OZ	\$6.95	
87602	WASHER, PLASTIC, 2 OZ	\$0.58	
87603	COLLAR, LOCKING, 2 OZ, LONG	\$8.94	
87620	CONDIMENT PUMP CP-8 1/2, 2 OZ	\$349.50	20
87624	SHROUD ASSEMBLY	\$606.17	
87640	CONDIMENT PUMP CP-1/3, 2 OZ	\$362.20	16
87659	COLLAR, GAGING, 1.000 IN(25.4MM) LG	\$7.85	
87660	CONDIMENT PUMP CP-F, 2 OZ	\$335.19	18
87661	LID, CP-F 2 OZ	\$43.07	
87663	TUBE, PLASTIC, 3.82 IN	\$16.58	
87679	LID, CP-10 1/2 2 OZ	\$71.47	
87680	CONDIMENT PUMP CP-10 1/2, 2 OZ	\$393.98	20
87702	SPRING, PAWL	\$4.96	
87703	ROD, DRIVE	\$64.61	
87707	LABEL, HANDLE INSTALLATION	\$6.22	
87725	KIT, LEVER ASSEMBLY	\$303.06	
87728	KIT, ADAPTER RING, CW-DI	\$279.59	
87731	TOP, CONSERVEWELL	\$68.06	
87733	ELEMENT ASSY, SILICONE, 120V 400W	\$90.77	
87736	VESSEL, DIPPER	\$286.51	
87740	CONSERVEWELL	\$870.56	53
87743	CUT-OUT, THERMAL ASSY, 184C, 7.18 IN	\$14.48	
87748	LABEL, LOGO, CONSERVEWELL	\$12.64	
87750	CONSERVEWELL W/COUNTDOWN TIMER	\$1,194.63	53
87755	CYLINDER ASSY BP-1, SILVER, 10 11/16	\$28.36	
87760	CONSERVEWELL DI	\$849.90	53
87768	KIT, LEVER ASSEMBLY, HINGED	\$262.61	
87770	CONSERVEWELL DI, PROGRAMMABLE	\$1,073.89	53
87771	PAN, CONSERVEWELL, DI W/EMBOSS	\$67.91	
87772	CONSERVEWELL DI, COUNTDOWN TIMER	\$1,073.89	
87773	CONSERVEWELL W/COUNTDOWN TIMER, NA	\$1,159.68	
87774	LINER, PAN, CW-DI	\$13.51	
87775	TRANSFORMER ASSEMBLY, 12VAC	\$49.56	
87776	LABEL, PROGRAMMABLE, CW-DI	\$7.45	
87777	LABEL, COUNTDOWN, CW-DI	\$7.97	
87778	LABEL, CONTROL, CW-DI	\$11.54	
87781	ELEMENT, SILICONE, 120V 100W	\$97.21	
87782	ELEMENT, SILICONE, 230V 100W	\$237.17	

item	description	list price	page
87785	BLOCK, LOCATOR (BLUE)	\$3.68	
87786	BLOCK, LOCATOR (RED)	\$3.68	
87793	BRACKET, CONSERVEWELL DI CLOSURE	\$18.35	
87794	CONSERVEWELL-DI QUICK START POSTER	\$14.44	
87795	GUARD, CORD	\$10.31	
87797	FOOT, PUSH-IN, RUBBER	\$3.57	
87798	LABEL, CORD CAUTION	\$4.04	
87800	THICK FOOD DISPENSER	\$711.69	
87819	LABEL, DIGITAL, FULL ACCESS TIMER	\$20.60	
87821	LABEL, DIGITAL, LIMITED ACCESS TIMER	\$17.62	
87828	TRANSFORMER ASSEMBLY, 12VAC	\$50.65	
87833	BOARD, TERMINAL EMI FILTER	\$20.17	
87839	SHROUD ASSEMBLY, CONSERVEWELL DI	\$102.95	
87841	KIT, CONSERVEWELL FOOT/RED LOCATOR	\$7.24	
87851	STAND, EZT/SERVER EXPRESS	\$826.07	
87857	COVER, DRIP TRAY, EZT/EXPRESS	\$36.85	
87858	TRAY, DRIP, EZT/SERVER EXPRESS	\$62.57	
87870	INSEASON, DROP 1/CNT, CLEAR	\$83.40	61
87880	INSEASON, SPREAD 1/CNT, CLEAR	\$83.40	61
87883	LID, INSEASON, CLEAR	\$17.41	
87884	BODY, INSEASON, CLEAR	\$35.36	
87885	SPREADER, WIDE DROP, CLEAR	\$16.29	
87886	SPREADER, 4 IN DIA DROP, CLEAR	\$16.29	
87915	LID, PLSTC, 1/12 SIZE, ORANGE KNOB	\$40.36	
87923	LID, PLASTIC, 1/12 SIZE	\$40.36	34, 35
87924	JAR, 1/12 SIZE, 6 IN DEEP, BLACK	\$10.42	
87925	JAR, 1/12 SIZE, 3.50 IN DEEP, BLACK	\$8.79	34, 35
87926	JAR, 1/12 SIZE, 6 IN DEEP, ORANGE	\$12.53	
87927	JAR, 1/12 SIZE, 3.50 IN DEEP, ORANGE	\$11.18	
87937	SHROUD ASSEMBLY	\$70.21	
87956	INSERT, THREADED	\$5.27	
87957	COLLAR, LOWER	\$7.59	
87963	CYLINDER ASSY BP-1, SILVER, 10 1/2	\$17.88	
87968	CYLINDER ASSEMBLY, BP-1/2	\$25.25	
87997	CYLINDER ASSY BP-1, SILVER, 9 1/4	\$11.43	
88000	BP-1, 38MM, 128 OZ, 10 IN DEEP	\$88.18	11
88016	CAP, PLSTC, 38MM, 1.156 HOLE, BLK	\$3.56	
88060	PUMP, PLASTIC	\$11.12	
88068	HEAD ASSEMBLY BP-1, 1 FL OZ, LONG	\$55.07	
88069	HEAD ASSEMBLY BP-1 1/2 FL OZ	\$45.58	
88085	CYLINDER ASSEMBLY, BP-1/4	\$25.25	
88089	CYLINDER ASSEMBLY, BP-1/2	\$25.25	
88098	CYLINDER ASSEMBLY, BP-1/2 AA	\$25.25	
88104	CAP, PLSTC, 53MM X .500, 1.156 HOLE	\$6.22	
88137	CYLINDER ASSEMBLY, BP-1/4	\$25.67	
88147	CYLINDER ASSEMBLY, BP-1/2, NO TUBE	\$25.25	
88154	HEAD ASSEMBLY BP-1, CBS BASE	\$60.85	
88155	COLLAR, GAGING-3/4 OZ	\$11.18	
88162	SEAL, BP-1/2 & 1/4	\$4.63	
88166	SPRING ASSEMBLY, BP-1	\$18.76	

## Server 2024 Price Guide (88180–88795)

item	description	list price	page
88180	BOTTLE PUMP BP-1/4	\$84.19	11
88188	VALVE, PINCH, BP-1/2 & 1/4	\$10.93	
88189	SPRING, BP-1/4	\$18.35	
88190	BOTTLE PUMP BP-1/2	\$84.19	11
88200	BP-1, 38MM, 64 OZ, 9 5/32 DEEP	\$88.18	
88202	VALVE, PINCH, BP-1	\$10.93	
88203	VALVE, TRILOBE PINCH, BP-1	\$11.95	
88204	COLLAR, GAGING-.25 OZ REDUCTION	\$3.98	
88205	COLLAR, GAGING-.50 OZ REDUCTION	\$4.80	
88210	BP-1, 38MM, LONG, 10 IN DP, BAGGED	\$81.01	
88213	CAP, PLSTC, 28MM X .500, .840 HOLE	\$3.56	
88220	BP-1, 38MM, 1 FL OZ, 1/2 IN TUBE	\$99.33	11
88232	HEAD ASSEMBLY, BP-1/2, BLACK COLLAR	\$60.85	
88233	SPRING, BP-1/2	\$16.68	
88253	KIT, BOTTLE & 28MM LID, NAT	\$19.46	
88258	BALL, 5/16 IN DIA, SS	\$2.18	
88276	CAP, PLSTC, 30.5MM, .840 HOLE	\$2.18	
88303	HEAD ASSEMBLY BP-1, 1 FL OZ	\$60.85	
88313	COLLAR, GAGING-.125 OZ REDUCTION	\$3.98	
88315	TUBE, SILICONE, 2.50	\$7.05	
88318	CYLINDER ASSY BP-1, SILVER, 9 7/8	\$12.85	
88329	KIT, BP-1, LONG 6 PACK	\$486.10	
88333	CYLINDER ASSEMBLY, BP-1/2	\$27.98	
88334	COLLAR, GAGING, 1.844 IN	\$5.05	
88344	COLLAR, GAGING-5/16 OZ, CREAM	\$5.80	
88348	CYLINDER ASSY BP-1, SILVER, 7 11/16	\$18.63	
88353	CAP, PLSTC, 38MM, 1.156 HOLE, BLUE	\$3.19	
88354	CYLINDER ASSY, SILVER, EXPRESS, BLU	\$11.19	
88386	HEAD ASSY BP-1, 1/2 FL OZ(2 PC),BLU	\$74.95	
88395	SPRING ASSEMBLY, BP-1, HEAVY	\$21.85	
88409	COLLAR, STOP	\$2.58	
88411	COLLAR, GAGING-1/2 OZ	\$5.14	
88443	CYLINDER ASSY BP-1, SILVER, 9 7/8	\$11.43	
88471	KIT, BOTTLE & 38MM LID, NAT	\$19.46	11
88478	HEAD ASSEMBLY BP-1, 1/2 FL OZ	\$52.47	
88497	CYLINDER ASSY, BP-1/4, 28MM NO TUBE	\$22.83	
88507	CYLINDER ASSY BP-1, SILVER, 7 13/32	\$25.67	
88508	LID, 89MM, PLSTC, NAT, 38MM FINISH	\$6.62	
88519	CYLINDER ASSY BP-1, SILVER, 9 7/16	\$11.43	
88522	HEAD ASSEMBLY BP-1, 1/8 FL OZ (2PC)	\$55.07	
88525	CYLINDER ASSY BP-1, SILVER, 8 3/8	\$13.91	
88531	KIT, REPLACEMENT PARTS, BP-1, OPT 1	\$59.57	
88545	HEAD ASSEMBLY BP-1, 1 FL OZ (2 PC)	\$55.07	
88548	BP-1, SYRUP POUCH PUMP	\$88.18	
88549	CYLINDER ASSY, SILVER, EXPRESS, BLK	\$11.95	
88554	GASKET, SILICONE	\$7.85	
88556	TUBE, HEAD	\$25.40	
88561	CYLINDER ASSEMBLY, 2 OZ	\$85.19	
88565	SEAL ASSEMBLY, 2 OZ	\$18.11	
88567	LID, CP-8 1/2 2 OZ	\$72.12	

item	description	list price	page
88568	COLLAR, GAGING-.50 OZ REDUCT, 2 OZ	\$6.62	
88569	TUBE, DISCHARGE, CP-8 1/2 2 OZ, 8.5"	\$79.49	
88571	COLLAR, GAGING-.25 OZ REDUCT, 2 OZ	\$6.22	
88588	CYLINDER ASSEMBLY, 2 OZ	\$82.57	
88596	LID, CP-1/3 2 OZ	\$83.65	
88598	CYLINDER ASSEMBLY, 2 OZ	\$86.78	
88612	FOOT, WIRE RACK	\$3.98	
88628	KIT, PUMP PARTS 2 OZ	\$71.48	
88652	WIRESWISS, 3 TIER, 1 LIT, RD, ASSY	\$130.27	30
88656	WIRESWISS, 3 TIER, 64 OZ, ASSEMBLY	\$130.27	30
88671	THERMOSTAT, 112C (234F)	\$48.28	
88681	LID, BP-1, ECO DISPENSER	\$16.14	
88682	SHROUD, BP-1 64 OZ	\$94.59	
88701	KIT, WIRESWISS, STAND ONLY	\$130.27	
88711	WIRESWISS, 3 TIER, 1/9 SIZE JAR COMBO	\$258.95	31
88716	LINK ASSEMBLY, WIRESWISS	\$58.39	31
88718	HEAD ASSY BP-1, BLK	\$67.62	
88719	CYLINDER ASSY BP-1, BROWN, 8 5/32	\$25.25	
88725	PORTION TRAY, 0.35 FL OZ PINK, 4 PACK	\$68.70	
88729	PORTION TRAY, .54 FL OZ CLR, 4 PACK	\$32.87	
88730	SLIMLINE DFD-2L DOUBLE COUNTERTOP	\$826.07	63
88730-CE	SLIMLINE DFD-2L DOUBLE COUNTERTOP	\$826.07	
88732	PORTION TRAY, .45 FL OZ BLK, 4 PACK	\$32.87	
88736	BODY, 1.4 LITER, SLIMLINE DFD	\$88.97	
88737	SLIMLINE, DRIP TRAY ASSY, SGL/TWIN	\$84.19	
88738	SLIMLINE, DRIP TRAY ASSY, TRIPLE	\$100.07	
88740	SLIMLINE DFD-2L TRIPLE COUNTERTOP	\$1,088.20	63
88740-CE	SLIMLINE DFD-2L TRIPLE COUNTERTOP	\$1,088.20	
88750	SLIMLINE DFD-2L, SINGLE, W/BACKET	\$293.89	62
88750-CE	SLIMLINE DFD-2L, SINGLE, W/BACKET	\$293.89	
88751	LID, BLACK, SLIMLINE DFD	\$29.38	
88752	BODY, 2 LITER, SLIMLINE DFD	\$88.97	
88753	CYLINDER, DFD	\$37.18	
88754	HANDLE, BLACK, DFD	\$31.38	
88760	SLIMLINE DFD-2L, DOUBLE, W/BACKET	\$571.90	62
88761	PAD, FRICTION, DFD	\$21.92	
88764	CUP, ADAPTER, SLIMLINE, DFD	\$27.40	
88764-CE	CUP, ADAPTER, SLIMLINE, DFD	\$27.40	
88766	BRACKET, MOUNTING ASSEMBLY, SINGLE	\$52.42	
88767	BRACKET, MOUNTING ASSEMBLY, DOUBLE	\$68.31	
88768	BRACKET, MOUNTING ASSEMBLY, TRIPLE	\$84.19	
88769	BRACKET, MOUNTING ASSEMBLY, QUAD	\$100.07	
88770	SLIMLINE DFD-2L, TRIPLE, W/BACKET	\$849.90	62
88770-CE	SLIMLINE DFD-2L, TRIPLE, W/BACKET	\$849.90	
88776	PIN, PIVOT ASSY, BLACK, DFD	\$25.58	
88779	SLIMLINE DFD-2L, NO BRACKET	\$270.06	
88779-CE	SLIMLINE DFD-2L, NO BRACKET	\$270.06	
88780	SLIMLINE DFD-2L, QUAD, W/BACKET	\$1,119.96	62
88780-CE	SLIMLINE DFD-2L, QUAD, W/BACKET	\$1,119.96	
88795	PORTION TRAY, .50 FL OZ WHT, 4 PACK	\$32.87	



## Server 2024 Price Guide (88796–100092)

item	description	list price	page
88796	PORTION TRAY, .75 FL OZ BLU, 4 PACK	\$32.87	
88797	PORTION TRAY,1.50 FL OZ PINK,4 PACK	\$32.87	
88799	PORTION TRAY,1.00 FL OZ GRN, 4 PACK	\$32.87	
88806	HANDLE, ORANGE, SLIMLINE	\$31.38	
88809	LID, ORANGE, SLIMLINE DFD	\$29.38	
88816	TRAY, DRIP, DOUBLE, SLIMLINE	\$37.73	
88828	COVER, DRIP TRAY, TRIPLE, SLIMLINE	\$36.02	
88845	PORTION TRAY, .82 FL OZ YEL, 4 PACK	\$32.87	
88858	SHROUD ASSEMBLY	\$77.94	
88864	CYLINDER ASSY BP-1,SILVER, 10 11/16	\$25.67	
88867	BRACKET, MOUNTING ASSY, DOUBLE	\$115.19	
88879	COLLAR, GAGING-.50 OZ REDUCTION	\$5.14	
88887	COLLAR, GAGING-.125 OZ REDUCTION	\$4.32	
88888	COLLAR, GAGING-.25 OZ REDUCTION	\$4.63	
88928	COLLAR, GAGING, 1.710 IN	\$5.05	
88931	HEAD ASSY BP-1,7/16 FL OZ(2 PC),BLK	\$74.95	
88941	COVER, DRIP TRAY, DOUBLE, SLIMLINE	\$27.85	
89264	SLIMLINE DFD-1.4L, SINGLE,W/BRACKET	\$293.89	62
89264-CE	SLIMLINE DFD-1.4L, SINGLE, W/BRACKET	\$293.89	
89267	SLIMLINE DFD-1.4L, QUAD, W/BRACKET	\$1,119.96	62
90016	LID, FOR 1/6 SIZE PAN (NO SLOT)	\$29.79	
90018	KIT, REPL THERMOSTAT FS-20SS	\$119.64	
90068	VESSEL, WATER ASSEMBLY	\$554.21	
90083	PAN, 1/3 SIZE, 6 IN DEEP	\$60.37	
90087	PAN, 1/6 SIZE, 2 1/2 IN DEEP	\$27.63	
90088	PAN, 1/6 SIZE, 4 IN DEEP	\$32.09	
90089	PAN, 1/6 SIZE, 6 IN DEEP	\$44.08	56
90092	LID, FOR 1/3 SIZE PAN	\$34.30	
90094	LID, FOR 1/6 SIZE PAN	\$29.38	56
90106	PAN, 1/9 SIZE, 4 IN DEEP	\$31.00	
90143	KNOB, HANDLE	\$6.79	
90183	ELEMENT, HEATING, 120V 1500W	\$200.58	
90184	FOOT, ADJUSTABLE	\$12.42	
90185	KNOB, THERMOSTAT	\$14.91	
90186	THERMOSTAT, 15 IN, 110C	\$92.50	
90187	LIGHT, INDICATOR, RED	\$17.21	
90188	LIGHT, INDICATOR, AMBER	\$17.21	
90191	LABEL, LOGO, SUPREME, FS-20SS	\$20.69	
90192	SENSOR, TEMPERATURE LIMIT	\$29.14	
90202	THERMOSTAT, 36 IN, 110C	\$133.31	
90204	KIT, REPL THERMOSTAT I-20, 36 IN	\$160.07	
90209	FITTING, PIPE	\$76.01	
90211	BRACKET, THERMOSTAT BULB	\$21.46	
90213	REFLECTOR, HEAT	\$75.27	
90216	SPACER, ELEMENT	\$43.72	
90217	INSULATION	\$33.86	
90252	VESSEL, WATER ASSEMBLY	\$548.78	
90261	COVER, HEAT REFLECTOR	\$101.43	
90266	FITTING, DRAIN	\$37.27	
90269	PAN ASSY, 1/2 SIZE, PERFORATED	\$325.26	

item	description	list price	page
90271	ELEMENT, HEATING, 120V 1500W	\$268.77	
90275	LEG, ADJUSTABLE, 10 1/2 IN	\$182.21	
90277	VALVE, BALL, 1/2 NPT	\$285.95	
90278	KNOB, DRAIN	\$17.06	
90279	LEVER, VALVE	\$131.93	
90281	STEM, VALVE	\$60.37	
90282	LABEL, HOT	\$62.27	
90289	ELEMENT, HEATING, 120V 15W	\$42.58	
92000	SINGLE DIP SERVER DI-1	\$489.29	54
92004	BOTTOM, REMOVABLE, DI-1	\$31.90	
92008	LID ASSEMBLY, DI-1	\$61.96	
92012	FOOT, RUBBER	\$1.08	
92020	DOUBLE DIP SERVER DI-2	\$532.17	54
92024	BOTTOM, REMOVABLE	\$45.54	
92026	LID ASSEMBLY, DI-2	\$69.97	
92040	TRIPLE DIP SERVER DI-3	\$600.50	54
92044	BOTTOM, REMOVABLE	\$66.92	
92046	LID ASSEMBLY, DI-3	\$84.62	
92053	THERMOSTAT, 38C	\$27.58	
92061	KIT, REPL HEATING ELEMENT DI-1	\$131.34	
92063	KIT, REPL HEATING ELEMENT DI-2	\$142.26	
92064	KIT, REPL HEATING ELEMENT DI-3	\$131.83	
92068	BUSHING, STRAIN RELIEF	\$4.90	
92098	FOOT, RUBBER, BUTTON	\$1.08	
92115	TOP, DI-1	\$43.89	
92116	TOP, DI-2	\$53.41	
92117	TOP, DI-3	\$64.61	
94000	CREAM SERVER CSM	\$694.21	20
94008	LID, STORAGE, STNLS JAR	\$45.68	
94009	JAR, STNLS	\$89.76	
94010	PUMP ONLY FOR CREAM SERVER	\$335.19	
94025	LID, CREAM SERVER	\$76.01	
94056	JAR, HOLD COLD, ROUND, WHITE	\$201.75	
94070	CONDIMENT SERVER MMS	\$689.45	20
94080	PUMP ONLY FOR CONDIMENT SERVER	\$312.97	
100001	BRACE, LEVER PUMP	\$30.02	
100003	THERMOSTAT/RETENTION STRIP ASSEMBLY	\$98.99	
100004	10 IN SPRING PACK	\$27.17	
100005	7 IN SPRING PACK	\$26.38	
100012	DPD, DRIP TRAY ASSY, SINGLE	\$90.06	
100013	DPD, DRIP TRAY ASSY, DOUBLE	\$92.45	
100015	STAND ASSEMBLY, INSWEETEN STATION	\$364.18	
100061	CAP, PLSTC, 38.5MM X .625, .840 HOLE	\$6.60	
100062	WHIPPED CAN HOLDER, HOLD COLD	\$143.45	
100066	FOOD SERVER SUPREME, EXPRESS CONN	\$1,384.17	49
100069	COLLAR, GAGING-10 ML	\$5.16	
100071	HEAD ASSEMBLY, BP-1/2, 10 ML	\$62.12	
100072	CYLINDER ASSEMBLY, BP-1/2, 10 ML	\$10.34	
100075	PISTON & SEAL ASSEMBLY 6.308	\$28.43	
100092	KIT, DISPERSION PLATE, CONSERVEWELL	\$35.94	

## Server 2024 Price Guide (100157–100826)

item	description	list price	page
100157	INSWEETEN STATION, QUAD	\$540.72	
100166	LID, BP-1	\$51.97	
100178	LID ASSY, EXPRESS TRIPLE LOCK-COMplete	\$204.88	
100186	LID ASSY, EXPRESS QUAD LOCK-COMplete	\$231.62	
100190	TUBE, DISCH, FP COMPACT, 14.5", 7 IN	\$93.53	
100192	LID, FP COMPACT, 14.5"	\$41.57	
100209	LID, CP-1/6 NF	\$45.19	
100214	KIT, TIMER BOARD (CONSERVEWELL)	\$219.72	
100219	KIT, PROPORTION REFILL, SINGLE	\$89.08	
100225	HEAD ASSEMBLY, BP-1/2, 1/8 OZ	\$48.99	
100236	EXPRESS SINGLE SS COUNTERTOP, DIRECT-POUR	\$511.54	17
100237	EXPRESS SINGLE SS DROP-IN, DIRECT-POUR	\$511.54	17
100239	PUMP, 45-50 DURO DOME, NO CONNECTOR	\$142.29	
100243	LID ASSY, EXPRESS SINGLE, DIRECT POUR-COMplete	\$74.74	
100280	VESSEL, DIRECT POUR, 1.3 GAL	\$44.20	
100281	LID, DIRECT POUR, 1.3 GAL	\$12.04	
100283	LID, DIRECT POUR, 3 GAL	\$12.04	
100322	COLLAR, GAGING, 4.527 IN (115MM)	\$6.68	
100325	HEAD ASSEMBLY BP SANITIZER, NO COLLAR	\$54.80	
100345	SEAL ASSEMBLY, MOLDED	\$5.77	
100386	IMPELLER OVERMOLD, TAPERED VANE	\$134.79	
100396	PANEL, SLIDE	\$21.43	
100401	KIT, SHROUD ASSEMBLY, DIRECT-POUR	\$237.15	
100411	TUBE, DISCHARGE, FP-200, 14.5"	\$47.05	
100412	LID, FP-200	\$12.12	
100414	LID, FP-200V SLIM	\$24.74	
100420	CONTROLLER, TEMPERATURE	\$247.93	
100481	DECAL SET, NORDSTROM, MAGNETIC	\$31.62	
100483	MENU BOARD & FRAME ASSEMBLY, TWIN	\$334.38	
100496	KIT, REPL HEATING ELEMENT-120V 250W	\$100.61	
100497	KIT, REPL HEATING ELEMENT-230V 250W	\$100.61	
100498	KIT, REPL HEATING ELEMENT-230V 1500W	\$164.26	
100499	KIT, REPL HEATING ELEMENT-230V 1000W	\$177.94	
100507	KIT, REPLACEMENT PARTS, BP-1	\$43.87	
100515	ICE PACK, UNIVERSAL	\$19.86	34, 41
100521	GROMMET, 1/4, RUBBER	\$0.36	
100536	LABEL, MOTION SENSOR	\$21.24	
100544	PIN, CLEVIS, 4 IN	\$25.38	
100563	TUBE, DISCHARGE, CP-F, 8.5" ELECTROPOLISH	\$97.65	
100566	LID, CP-F ELECTROPOLISH	\$31.76	
100567	LID, CP-F SLIM ELECTROPOLISH	\$33.05	
100603	TUBE, DISCHARGE, FP-200, 14.5"	\$59.08	
100619	TRAY, DRIP	\$60.47	
100632	CAP, PLSTC, SPECIAL, .850 HOLE	\$11.74	
100634	PLATE, PUSH	\$18.48	
100647	CYLINDER ASSEMBLY, BP-1/4, SPECIAL CAP	\$22.67	
100751	BUSHING, FLANGED	\$13.20	

item	description	list price	page
100752	FOOD SERVER PUMP, .545 OZ	\$247.53	
100753	LOCK, THERMOSTAT	\$36.98	
100754	COLLAR, GAGING-.545 OZ	\$9.34	
100790	PISTON & SEAL ASSEMBLY 8.505, 2 OZ	\$29.86	
100793	PISTON & SEAL ASSEMBLY 7.402	\$29.86	
100804	PISTON & SEAL ASSEMBLY 7.562	\$29.86	
100805	PISTON & SEAL ASSEMBLY 7.160, 2 OZ	\$29.86	
100812	TRIGGER ASSEMBLY, .65 TSP, TAN, INSWEETEN	\$11.14	
100826	LID, CP-1/3, ROTATED, TJ	\$52.87	



# SERVER<sup>®</sup>

---

• E S S E N T I A L S •

Tel: 1.203.847.6446 | Fax: 1.203.849.9526  
[sales@dsusa.biz](mailto:sales@dsusa.biz) | [www.dsusa.biz](http://www.dsusa.biz)

